

wingletTM system



BRALCO
YOUR SMART ITALIAN OFFICE

index

winglet system	2
mouvement	6
executive	21
operative	41
meeting	67
domomag	79
technical	95

GAMBE - legs - piètements - beine - poten - patas



STRUTTURA A T

T-shaped structure - structure en T - T-gestell - T-vorm onderstel - estructura en T



STRUTTURA AD L

L-shaped structure - structure en L - L-gestell - L-vorm onderstel - estructura en L

FISSA H 74 - 29" - fixed - fixe - feststehend - vast - fija



L 60 - 80
23 3/4" - 31 1/2"

L 80
31 1/2"

MOBILE - mobile - mobile - beweglich - verplaatsbaar - móvil

PULSANTE

H 65/85 - 25 1/2" / 33 1/2"
push button - bouton-poussoir -
schalter - drukknop - pulsador



L 60 - 80
23 3/4" - 31 1/2"

L 80
31 1/2"

MANOVELLA

H 65/85 - 25 1/2" / 33 1/2"
crank - manivelle - kurbel -
slinger - manivela



L 80
31 1/2"

ELETTRICA

H 65/130 - 25 1/2" / 51"
electrical - électrique - elektrisch -
elektrisch - eléctrico

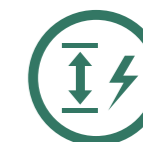

L 80
31 1/2"

RIBALTABILE H 74 - 29" - folding leg - rabattable - klappbar - opklapbaar - abatible

SU RUOTE

with castors - sur roulettes - auf
rollen - op wielen - sobre ruedas

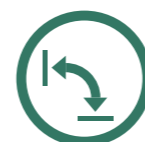

L 80
31 1/2"

winglet™

un sistema pensato e realizzato
in conformità e nel rispetto
della normativa Europea
EN 527-1:2011

a system designed and built in
compliance with
European Standard
EN 527-1:2011

un système conçu et réalisé
en conformité et dans le respect
de la norme Européenne
EN 527-1:2011

ein in Übereinstimmung mit der
europäischen Normvorschrift EN
527-1: 2011 und unter Einhaltung
der entsprechenden Bestimmungen
konzipiertes und hergestelltes System

een systeem dat ontworpen en
gerealiseerd is
in overeenstemming
met de Europese regelgeving
EN 527-1:2011

un sistema pensado y realizado
en cumplimiento y conformidad
de la normativa europea
EN 527-1:2011

La normativa individua 4 tipologie di scrivanie

The standard includes 4 different types of desktops - La norme
identifie 4 typologies de bureaux - Die Normvorschrift sieht 4
Arten von Schreibtischen vor - De regelgeving vermeldt 4 soorten
schrijftafels - La normativa identifica 4 tipos de escritorios

1. TIPO A - TYPE A - TYPE A - TYP A - TYPE A - TIPO A

Scrivanie ad altezza regolabile in continuo anche da parte dell'utente

Continuously height-adjustable desktops - Bureaux à hauteur réglable en continu en
cours d'utilisation - Schreibtische, die auch vom Benutzer stufenlos höhenverstellbar sind
- Schrijftafels waarvan de hoogte voortdurend door de gebruiker versteld kan worden -
Escritorios de altura regulable de modo continuo, incluso por parte del usuario

2. TIPO B - TYPE B - TYPE B - TYP B - TYPE B - TIPO B

Scrivanie ad altezza selezionabile al momento dell'installazione

Desktops whose height can be adjusted at the time of installation - Bureaux à hauteur
sélectionnable lors du montage - Schreibtische, deren Höhe beim Aufbau wählbar ist -
Schrijftafels waarvan de hoogte ingesteld kan worden tijdens de installatie - Escritorios de
altura seleccionable en el momento de la instalación

3. TIPO C - TYPE C - TYPE C - TYP C - TYPE C - TIPO C

Scrivanie ad altezza fissa

Fixed height desktops - Bureaux à hauteur fixe - Schreibtische mit feststehender Höhe -
Schrijftafels met vaste hoogte - Escritorios de altura fija

4. TIPO D - TYPE D - TYPE D - TYP D - TYPE D - TIPO D

Scrivanie ad altezza regolabile o selezionabile, ma con intervallo di regolazione ridotto

Height-adjustable desktops with reduced setting range - Bureaux à hauteur réglable ou
sélectionnable mais avec une plage de réglage limitée - Schreibtische mit verstellbarer
bzw. wählbarer Höhe, aber mit eingeschränktem Einstellintervall - Schrijftafels met
verstelbare of instelbare hoogte, maar met een beperkte verstelbaarheid - Escritorios de
altura regulable o seleccionable, pero con intervalo de regulación reducido

FISSA H 74 - 29" - fixed - fixe - feststehend - vast - fija

TIPO C
TYPE C - TYPE C
TYP C - TYPE C
TIPO C

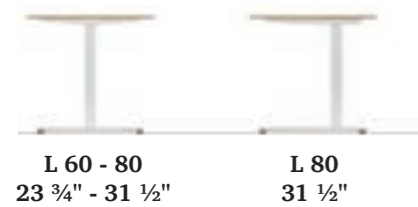

MANOVELLA H 65/85 - 25 1/2"/33 1/2" - crank - manivelle - kurbel - slinger - manivela

TIPO D
TYPE D - TYPE D
TYP D - TYPE D
TIPO D

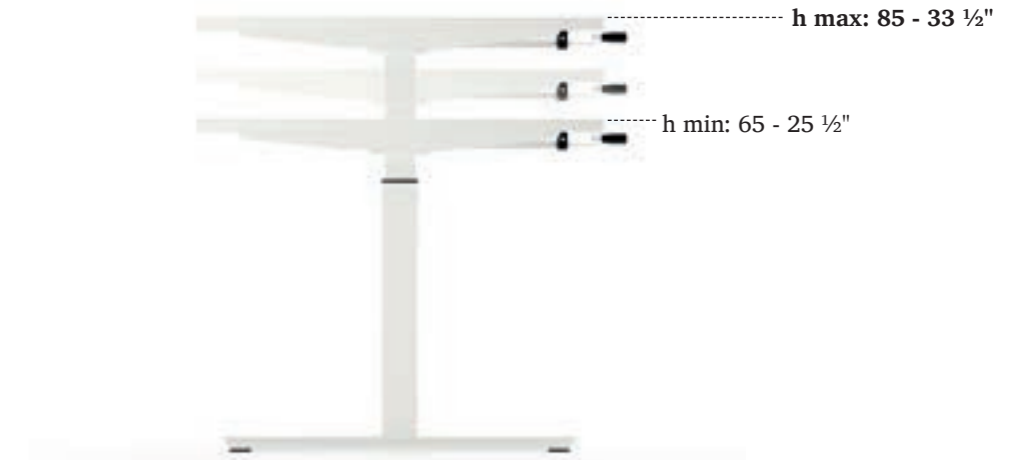

PULSANTE H 65/85 - 25 1/2"/33 1/2" - push button - bouton-poussoir - schalter - drukknoop - pulsador

TIPO B
TYPE B - TYPE B
TYP B - TYPE B
TIPO B

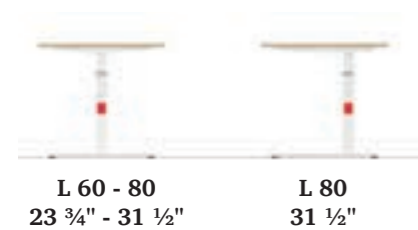
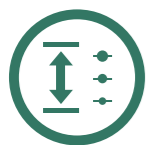

Uno scatto ogni 2 cm - One step every 2 cm - Un cran tous les 2 cm - Eine Kerbe alle 2 cm - Eén klik om de 2 cm - Una posición cada 2 cm

h max: 85 - 33 1/2"

↑ 67 - 26 1/4", ↑ 69 - 27", ↑ 71 - 28", ↑ 73 - 28 3/4",
↑ 75 - 29 1/2", ↑ 77 - 30 1/4", ↑ 79 - 31", ↑ 81 - 31 3/4",
↑ 83 - 32 3/4"

h min: 65 - 25 1/2"

ELETTRICA H 65/130 - 25 1/2"/51" - electrical - électrique - elektrisch - elektrisch - eléctrico

TIPO A
TYPE A - TYPE A
TYP A - TYPE A
TIPO A

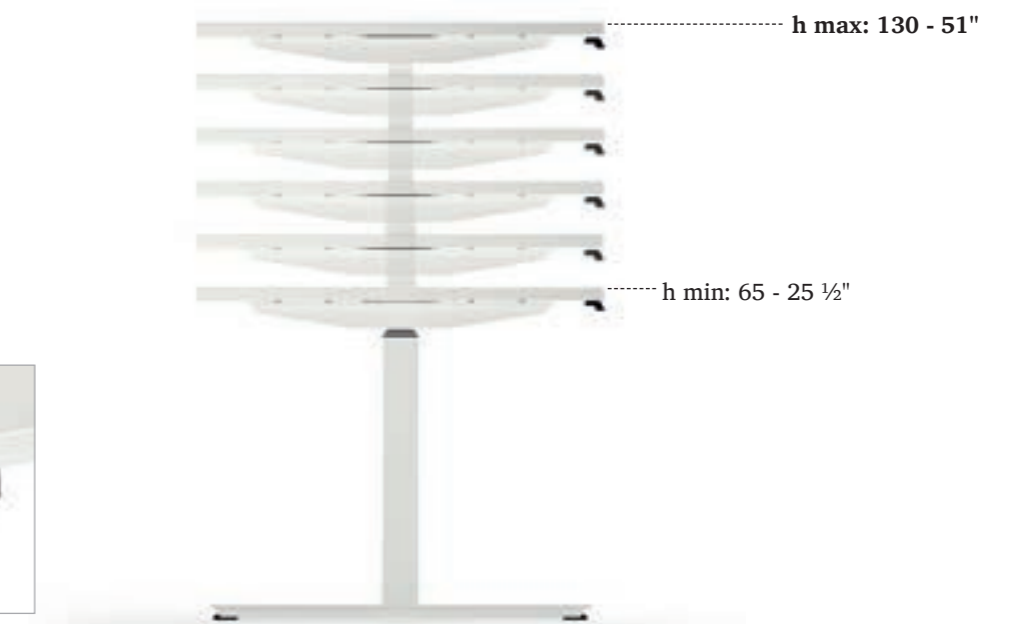

ESTENSIONE - extention - extension - erweiterung - uitbreiding - extensión

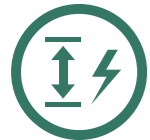

LAVORO DA SEDUTO O IN PIEDI

work standing or sitting down - travail assis ou debout - arbeit im sitzen oder im stehen - zittend of rechtstaand werken - trabajo sentado o de pie

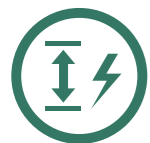

TRAVI TELESCOPICHE - telescopic beams - poutres télescopiques - teleskoptraversen - telescopische buisjes - vigas telescópicas

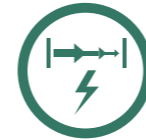

**Semplice, facile, riconfigurabile:
tre misure, una sola struttura
telescopica**

Simple, easy, adjustable:
three measures, one telescopic structure

Simple, facile, reconfigurable :
trois dimensions, une seule structure
télescopique

Simpel, einfach, rekonfigurierbar: drei
Abmessungen, ein einziges ausziehbares Gestell

Eenvoudig, gemakkelijk, herconfigureerbaar:
Drie afmetingen, één telescopisch onderstel

Simple, fácil, reconfigurable:
tres medidas, una sola estructura
telescópica



DA SCRIVANIA A BENCH

from desktop to bench - de bureau à bench - von schreibtisch zu bench -
van schrijftafel tot bench-compositie - de escritorio a bench



versione standard
Standard version - Version standard -
Standard-Version - Standaardversie -
Versión estándar



Travi fisse di collegamento 1 e 2
Fixed connection beams 1 & 2 - Poutres fixes de liaison 1
et 2 - Feststehende Verkettungstraversen 1 und 2 - Vaste
verbindingsbuizen 1 en 2 - Vigas fijas de conexión 1 y 2



2° Scrivania
Second desktop - 2e Bureau -
2. Schreibtisch - 2e Schrijftafel -
2.º Escritorio



Vasca passacavi telescopica
Telescopic cable holder tray - Bac passe-câbles
télescopique - Ausziehbare Kabelrinne - Telescopische
kabelgoot - Bandeja pasacables telescópica

TIPO A - TYPE A - TYPE A - TYP A - TYPE A - TIPO A



Esempi di configurazione con e senza muretto
Layout examples with and without wall - Exemples de configuration
avec et sans piètement plein - Konfigurationsbeispiele mit und ohne
Wange - Configuratievoorbeelden met en zonder wand - Ejemplos de
configuración con y sin tabique



TAVOLO SU RUOTE CON PIANO RIBALTABILE - wheeled table with folding leg - table sur roulettes avec plateau rabattable - tisch auf rollen mit klappbarer platte - tafel op wielen met opklapbaar paneel - mesa sobre ruedas con sobre abatible

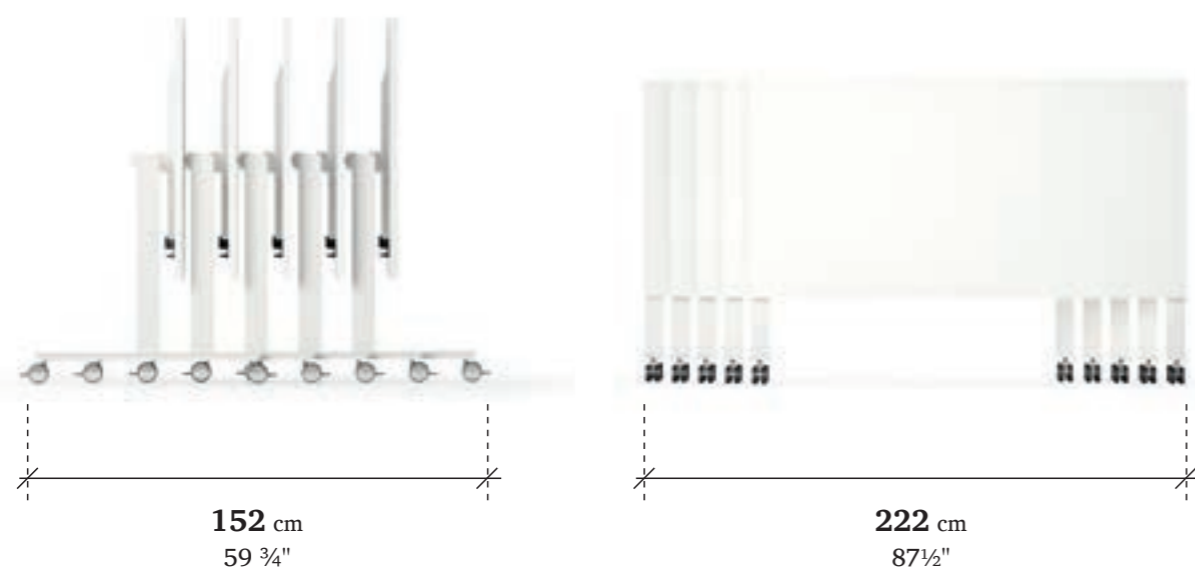
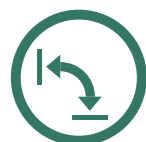

Un sistema semplice e veloce per ridurre al minimo gli ingombri

A simple and fast system to reduce the footprint to a minimum

Un système simple et rapide pour réduire au minimum l'encombrement

Ein einfaches und schnelles System, um den Platzbedarf zu minimieren

Een eenvoudig en snel systeem. om de ingenomen plaats tot een minimum te beperken

Un sistema simple y rápido para reducir al mínimo los volúmenes



winglet™,
il più evoluto sistema per postazioni
ad alta efficienza ergonomica.

The most evolved system
for highly-ergonomic stations.

le système le plus évolué pour des postes
de travail à haute efficacité ergonomique.

das modernste System für höchst
ergonomische Arbeitsplätze.

het meest geavanceerde systeem
voor ergonomische werkplaatsen.

el sistema más evolucionado para puestos
de trabajo de alta eficiencia ergonómica.



bench system

TIPO A
TYPE A - TYPE A
TYP A - TYPE A
TIPO A

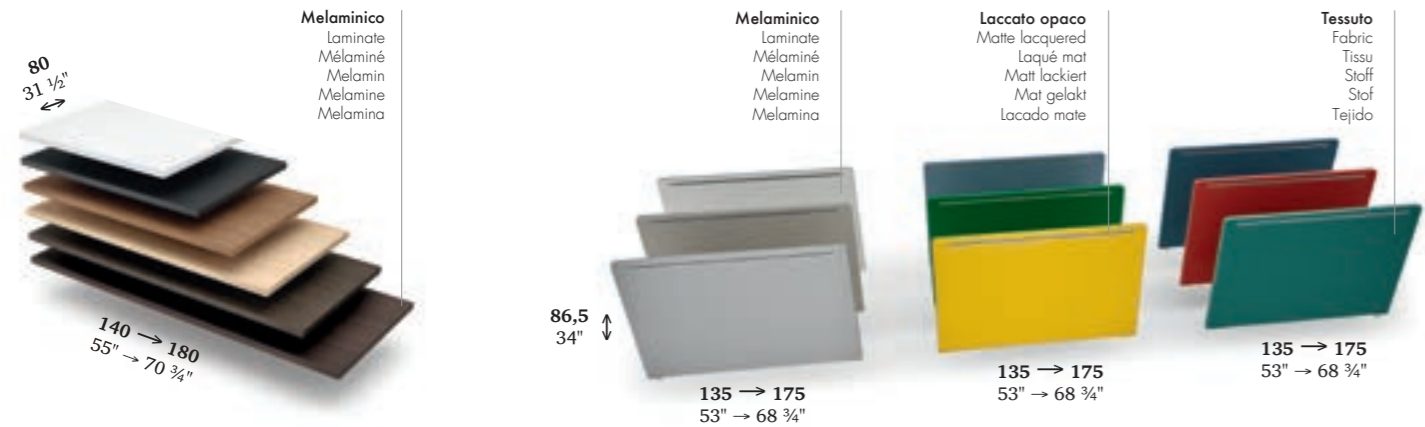

Gamba centrata
Middle leg
Piétement centré
Bain in der Mitte
Gecentreerde poot
Pata centrada

Gamba pannello
Panel leg
Piétement panneau
Plattenbein
Poot paneel
Pata tablero

Pannelli di tamponamento
Side panels
Panneaux de remplissage
Seitenpaneele
Bufferpanelen
Tableros de compensación

Muretto
Side panels
Panneaux de remplissage
Seitenpaneele
Bufferpanelen
Tableros de compensación



bench system

TIPO D
TYPE D - TYPE D
TYP D - TYPE D
TIPO D

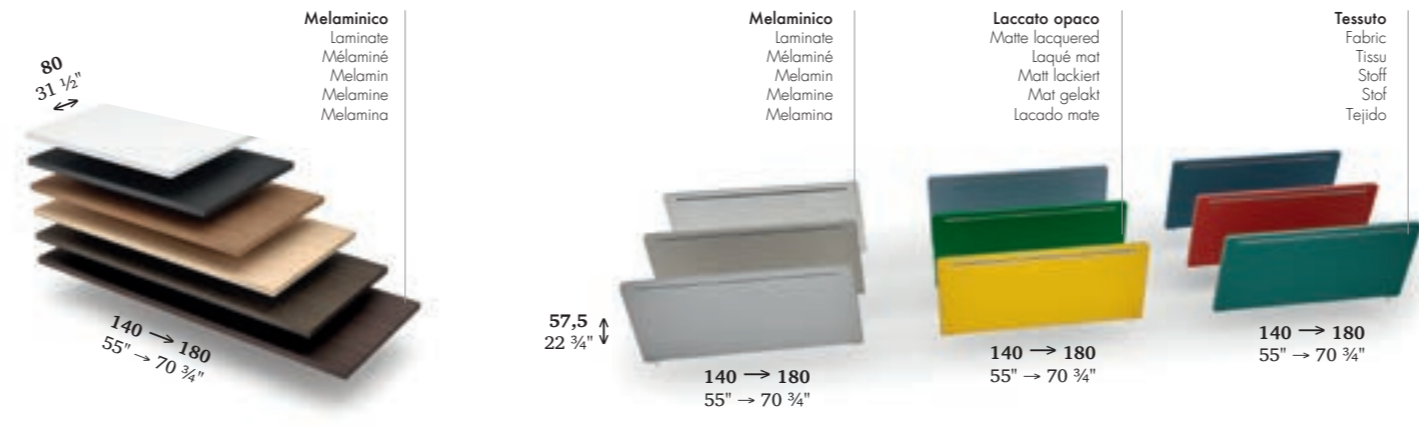

Gamba centrata
Middle leg
Piétement centré
Bain in der Mitte
Gecentreerde poot
Pata centrada

Gamba pannello
Panel leg
Piétement panneau
Plattenbein
Poot paneel
Pata tablero

Pannelli di tamponamento
Side panels
Panneaux de remplissage
Seitenpaneele
Bufferpanelen
Tableros de compensación



desk system

TIPO B
TYPE B - TYPE B
TYP B - TYPE B
TIPO B

TIPO C
TYPE C - TYPE C
TYP C - TYPE C
TIPO C

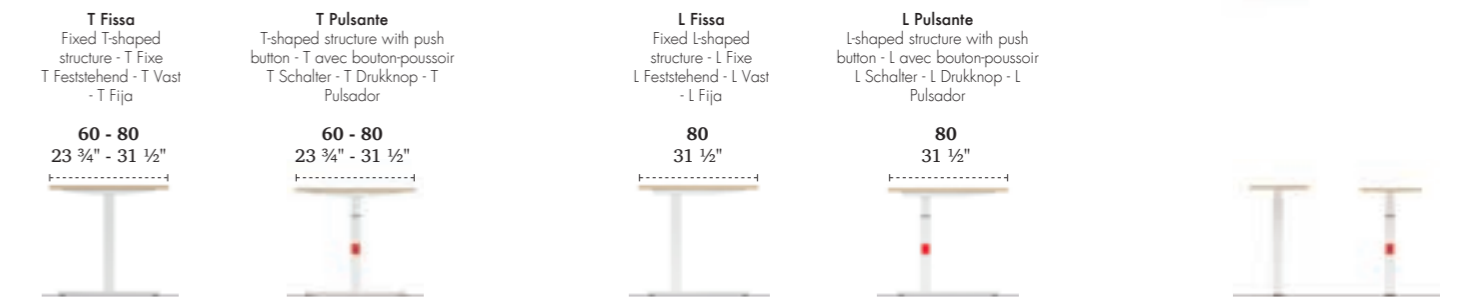
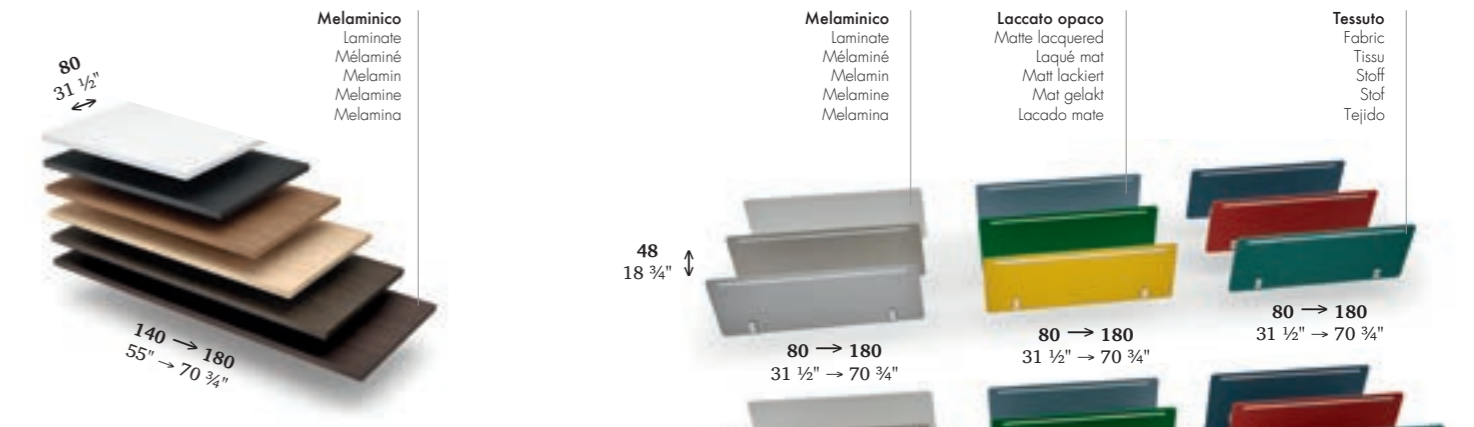

T Fissa
Fixed T-shaped structure - T Fixe
T Feststehend - T Vast
- T Fija

60 - 80
23 3/4" - 31 1/2"

T Pulsante
T-shaped structure with push button - T avec bouton-poussoir
T Schalter - T Drukknop - T Pulsador

60 - 80
23 3/4" - 31 1/2"

L Fissa
Fixed L-shaped structure - L Fixe
L Feststehend - L Vast
- L Fija

80
31 1/2"

L Pulsante
L-shaped structure with push button - L avec bouton-poussoir
L Schalter - L Drukknop - L Pulsador

80
31 1/2"

Fissa centrale
Fixed middle structure
Fixe central
Feststehend in der Mitte
Vast gecentreerd
Fija central

Reg. in H. a pulsante centrale
Heightadjustable structure with central push button
Rég. en H. avec bouton-poussoir central
Höhenverstellbar mit zentraler Schalter
Hoogte instelbaar met gecentreerde drukknop
Reg. en H. con pulsador central

Fissa decentrata
Fixed decentralized structure
Fixe décentré
Feststehend außermittig
Vast aan de zijkant
Fija decentrada

Reg. in H. a pulsante decentrata
Heightadjustable structure with decentralized push button
Rég. en H. avec bouton-poussoir décentré
Höhenverstellbar mit außermittigem Schalter
Hoogte instelbaar met drukknop aan de zijkant
Reg. en H. con pulsador decentrada

Puntale
Ferrule
Piétement
Stützbein
Punt
Pata de apoyo

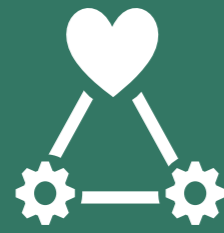

Una struttura collaudata un "cuore" forte e tecnologico, soluzioni sicure, affidabili e silenziose con 2 motori

A tested structure, a strong and tech-savvy core, safe, reliable and noiseless solutions with 2 motors -
 Une structure éprouvée, un « cœur » puissant et technologique, des solutions sûres, fiables et silencieuses avec 2 moteurs - Ein bewährtes Gestell mit einem starken und technologischen "Herzen", sichere, zuverlässige und geräuscharme Lösungen mit 2 Motoren - Een getest onderstel, een sterk en technologisch "hart", veilige oplossingen, betrouwbaar en geruisloos met 2 motoren -
 Una estructura probada: un « corazón » fuerte y tecnológico, soluciones seguras, fiables y silenciosas con 2 motores

winglet
 executive



Altezza minima/massima: 62,5/127,5 cm da terra a sotto piano.
 Minimum/maximum height: 62,5/127,5 cm from the ground to the top. - Hauteur minimale/maximale : 62,5/127,5 cm du sol jusqu'au-dessus du plateau. - Minimale/maximale Höhe: 62,5/127,5 cm vom Boden bis zur Oberkante der Tischplatte. - Min./max. hoogte: 62,5/127,5 cm van de vloer tot bovenkant blad. - Altura mínima/máxima: 62,5/127,5 cm desde el suelo hasta encima del sobre.



Passo a regolazione continua.
 Continuous adjustment pitch. - Pas à réglage continu. - Stufenlos einstellbare Höhe. - Met continu instelling. - Paso de regulación continua.



Regolazione con pulsante up&down in dotazione.
 Up&down button adjustment supplied. - Réglage avec bouton up&down fourni. - Einstellung mit standardmäßigem Up&Down-Schalter. - Instelling met bijgeleverde up&down-drukknop. - Regulación con pulsador up&down suministrado.



Regolazione disponibile, su richiesta, con pulsante up&down, display LCD con indicata la misura e memoria su 4 posizioni.
 Up&down button adjustment supplied. - Réglage avec bouton up&down fourni. - Einstellung mit standardmäßigem Up&Down-Schalter. - Instelling met bijgeleverde up&down-drukknop. - Regulación con pulsador up&down suministrado.



Cicli di utilizzo: 10.000 cicli certificati.
 Electric motor has been tested and certified for 10,000 cycles of use - Cycles d'utilisation : 10 000 cycles certifiés - Verwendungszyklen: 10.000 zertifizierte Zyklen - Test: 10.000 gecertificeerde bewegingen - Ciclos de uso: 10 000 ciclos certificados.



Peso massimo elevabile: 120 Kg (uniformemente distribuiti).
 Maximum weight load: 120 kg (uniformly distributed) - Poids maximum relevable : 120 kg (distribués uniformément) - Höchste Traglast: 120 kg (gleichmäßig verteilt) - Maximaal gewicht tijdens verstellen: 120 kg (gelijkmatig verdeeld) - Peso máximo elevable: 120 kg (uniformemente distribuidos)



Presenza di fermi di sicurezza: sia in salita che in discesa.
 Lifting and lowering safety retainers - Présence de butées de sécurité : vers le haut et vers le bas - Sicherheitsarretierung: Aufwärts und abwärts - Veiligheidsslot tijdens omhoog- en omlaag bediening - Presencia de topes de seguridad: tanto en subida como en bajada



Certificazioni di conformità TUV sull'impianto elettrico.
 Lifting and lowering safety retainers - Présence de butées de sécurité : vers le haut et vers le bas - Sicherheitsarretierung: Aufwärts und abwärts - Veiligheidsslot tijdens omhoog- en omlaag bediening - Presencia de topes de seguridad: tanto en subida como en bajada



Meccanismo premontato all'origine e motori integrati nella gamba, plug&play.
 Plug&play; pre-fitted mechanism and leg motors. - Mécanisme préinstallé à l'origine et moteurs incorporés dans le piètement, plug&play. - Vorinstallierter Mechanismus und im Tischbein integrierte Motoren, Plug&Play. - Voorgemonteerd mechanische en ingebouwde motoren in de poot, plug&play. - Mecanismo premontado de fábrica y motores integrados en la pata, plug&play.



Rumorosità di funzionamento: 39 dB.
 Noise output: 39dB - Bruit de fonctionnement : 39 dB - Betriebsgeräusch: 39 dB - Geluid: 39 dB - Nivel de ruido durante el funcionamiento: 39 dB

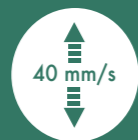

Velocità di salita/discesa: 40 mm/s.
 Lifting/lowering speed = 40mm/second - Vitesse de montée/descente : 40 mm/s - Geschwindigkeit auf/ab: 40 mm/s - Omhoog- en omlaag snelheid: 40 mm/s. - Velocidad de subida/bajada: 40 mm/s



Consumo energetico: 0.00277kWh/giorno, 0,87Kwh/anno considerando 3 regolazioni giornaliere.
 Energy consumption: 0,00277kw/day, 0,87/year based on 3 daily adjustments. - Consommation d'énergie : 0,00277 kWh/jour, 0,87 kWh/an, considérant 3 réglages quotidiens - Energieverbrauch: 0,00277 kWh/Tag, 0,87 kWh/Jahr bei 3 täglichen Verstellungen - Energieverbruik: 0,00277 kWh/dag, 0,87 kWh/jaar, bij 3 maal daags gebruik - Consumo energético: 0,00277 kWh/día, 0,87 kWh/año considerando 3 regulaciones diarias

Gambe: verniciate epox bianco / **Piani + mobile Eko + credenza:** melaminico rovere naturale / **Ante credenza:** vetro temperato satinato

Legs: white epoxy paint finish / Tops + Eko cabinet + sideboard: natural oak laminate / Sideboard doors: satin-finished tempered glass

Prètements: laqués epoxy blanc / Plateaux + meuble Eko + armoire basse: mélaminé chêne naturel / Portes armoire basse: verre trempé satiné

Beine: Pulverbeschichtung Weiß / Tischplatten + Möbel Eko + Sideboard: Melamin Eiche Natur / Türen Sideboard: mattiertes temperiertes Glas

Poten: wit geverfd epoxy / Bladen + meubel Eko + kast: melamine eikenhout natuur / Kastdeuren: gesatineerd gehard glas

Patas: barnizadas epoxi blanco / Sobres + mueble Eko + aparador: melamina roble natural / Puertas aparador cristal templado satinado



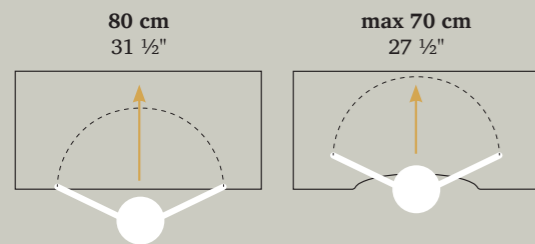

Scrivania
Desktop - Bureau -
Schreibtisch - Schrijftafel
- Escritorio

Scrivania ERGO
Ergo desktop - Bureau Ergo -
Schreibtisch ERGO - Schrijftafel
ERGO - Escritorio Ergo

**Gambe: verniciate epox bianco / Piani + mobile Eko:
melaminico rovere naturale / Ante
credenza: vetro temperato satinato**

Legs: white epoxy paint finish / Tops + Eko cabinet +
sideboard: natural oak laminate / Sideboard doors:
satin-finished tempered glass

Piètements: laqués epoxy blanc / Plateaux + meuble Eko
+ armoire basse: mélaminé chêne naturel / Portes armoire
basse: verre trempé satiné

Beine: Pulverbeschichtung Weiß / Tischplatten + Möbel
Eko + Sideboard: Melamin Eiche Natur / Türen Side-
board: mattiertes temperiertes Glas

Poten: wit gevefd epoxy / Bladen + meubel Eko + kast:
melamine eikenhout natuur / Kastdeuren: gesatineerd
gehard glas

Patas: barnizadas epoxi blanco / Sobres + mueble Eko
+ aparador: melamina roble natural / Puertas aparador
cristal templado satinado

**Gambe: verniciate epox bianco / Piani + mobile Eko:
melaminico rovere naturale**

Legs: white epoxy paint finish / Tops + Eko cabinet:
natural oak laminate

Piètements: laqués epoxy blanc / Plateaux + meuble Eko :
mélaminé chêne naturel

Beine: Pulverbeschichtung Weiß / Tischplatten + Möbel
Eko: Melamin Eiche Natur

Poten: wit gevefd epoxy / Bladen + meubel Eko: melami-
ne eikenhout natuur

Patas: barnizadas epoxi blanco / Sobres: melamina roble
natural



**Gambe: verniciate epox bianco / Piani + mobile
Eko + credenza: melaminico rovere naturale / Ante
credenza: vetro temperato satinato**

Legs: white epoxy paint finish / Tops + Eko cabinet +
sideboard: natural oak laminate / Sideboard doors:
satin-finished tempered glass

Piètements: laqués epoxy blanc / Plateaux + meuble Eko
+ armoire basse: mélaminé chêne naturel / Portes armoire
basse: verre trempé satiné

Beine: Pulverbeschichtung Weiß / Tischplatten + Möbel
Eko + Sideboard: Melamin Eiche Natur / Türen Side-
board: mattiertes temperiertes Glas

Poten: wit gevefd epoxy / Bladen + meubel Eko + kast:
melamine eikenhout natuur / Kastdeuren: gesatineerd
gehard glas

Patas: barnizadas epoxi blanco / Sobres + mueble Eko
+ aparador: melamina roble natural / Puertas aparador
cristal templado satinado



**Gambe: verniciate epox bianco /
Piani: melaminico rovere naturale**

Legs: white epoxy paint finish /
Tops: natural oak laminate

Piètements: laqués epoxy blanc /
Plateaux: mélaminé chêne naturel

Beine: Pulverbeschichtung Weiß /
Tischplatten: Melamin Eiche Natur

Poten: wit gevefd epoxy /
Bladen: melamine eikenhout natuur

Patas: barnizadas epoxi blanco /
Sobres: melamina roble natural

Gambe: verniciate epox bianco / **Piani:** melaminico noce canaletto / **Cassettiera:** melaminico bianco / **Top e fianchi armadio:** melaminico noce canaletto / **Ante armadio:** melaminico noce canaletto e vetro temperato satinato

Legs: white epoxy paint finish / **Tops:** Canaletto walnut laminate / **Chest of drawers:** white laminate / **Closet top and sides:** Canaletto walnut laminate / **Closet doors:** Canaletto walnut laminate and satin-finished tempered glass

Piètements: laqués epoxy blanc / **Plateaux:** mélaminé noyer canaletto / **Caisson:** mélaminé blanc / **Top et côtés armoire:** mélaminé noyer canaletto / **Portes armoire:** mélaminé noyer canaletto et verre trempé satiné

Beine: Pulverbeschichtung Weiß / **Tischplatten:** Melamin Canaletto Nussbaum / **Container:** Melamin Weiß / **Abdeckplatte und Seiten Schrank:** Melamin Canaletto Nussbaum / **Türen Schrank:** Melamin Canaletto Nussbaum und mattiertes temperiertes Glas

Poten: wit geveerd epoxy / **Bladen:** melamine notenhout canaletto / **Ladekast:** wit melamine / **Top en zijpanelen kast:** melamine notenhout canaletto / **Kastdeuren:** melamine notenhout canaletto en gesatineerd gehard glas

Patas: barnizadas epoxi blanco / **Sobres:** melamina nogal canaletto / **Cajonera:** melamina blanco / **Encimera y costados armario:** melamina nogal canaletto / **Puertas armario:** melamina nogal canaletto y cristal templado satinado





**Colonna con base: verniciate epox bianco /
Piano: melaminico noce canaletto**

Column with base: white epoxy paint finish /
Top: Canaletto walnut laminate

Colonne avec base: laqués epoxy blanc /
Plateau: mélaminé noyer canaletto

Säule mit Fuß: Pulverbeschichtung Weiß /
Tischplatte: Melamin Canaletto Nussbaum

Kolom met basis: wit geveerd epoxy /
Blad: melamine notenhout canaletto

Column con base: barnizadas epoxi blanco /
Sobre: melamina nogal canaletto



**Gambe: verniciate epox bianco / Piani: melaminico noce
canaletto / Cassettiera: melaminico bianco / Top e fianchi
armadio: melaminico noce canaletto / Ante armadio:
melaminico noce canaletto e vetro temperato satinato**

Legs: white epoxy paint finish / Tops: Canaletto walnut
laminate / Chest of drawers: white laminate / Closet top and
sides: Canaletto walnut laminate / Closet doors: Canaletto
walnut laminate and satin-finished tempered glass

Piètements: laqués epoxy blanc / Plateau: mélaminé noyer
canaletto / Caisson: mélaminé blanc / Top et côtés armoire:
mélaminé noyer canaletto / Portes armoire: mélaminé noyer
canaletto et verre trempé satiné

Beine: Pulverbeschichtung Weiß / Tischplatte: Melamin
Canaletto Nussbaum / Container: Melamin Weiß /
Abdeckplatte und Seiten Schrank: Melamin Canaletto
Nussbaum / Türen Schrank: Melamin Canaletto Nussbaum und
mattiertes temperiertes Glas

Poten: wit geveerd epoxy / Bladen: melamine notenhout
canaletto / Ladekast: wit melamine / Top en zijpanelen
kast: melamine notenhout canaletto / Kastdeuren: melamine
notenhout canaletto en gesatineerd gehard glas

Patas: barnizadas epoxi blanco / Sobres: melamina nogal
canaletto / Cajonera: melamina blanco / Encimera y
costados armario: melamina nogal canaletto / Puertas armario:
melamina nogal canaletto y cristal templado satinado



winglet[™] executive

Gambe: verniciate cromo lucido e epox bianco /
Piani + top e fianchi armadio: melaminico wengé
scuro / **Ante armadio:** melaminico wengé scuro e
vetro temperato satinato / **Cassettiera:** melaminico
bianco

Legs: polished chrome and white epoxy paint finish /
Closet shelves, top and sides: Dark wenge laminate /
Closet doors: Dark wenge laminate and satin-finished
glass / Chest of drawers: white laminate

Piètements: laqués chrome brillant et époxy blanc /
Plateaux + top et côtés armoire: mélaminé wengé foncé
/ Portes armoire: mélaminé wengé foncé et verre trempé
satiné / Caisson: mélaminé blanc

Beine: Glanzverchromt und Pulverbeschichtung Weiß /
Tischplatten + Abdeckplatte und Seiten Schrank: Melamin
Wengé dunkel / Türen Schrank: Melamin wengé dunkel
und mattiertes temperiertes Glas / Container: Melamin
Weiß

Poten: gevefd glanzend chroom en wit epoxy / Bladen
+ top en zijpanelen kast: melamine donker wengé /
Kastdeuren: melamine donker wengé en gesatineerd
gehard glas / Ladekast: wit melamine

Patas: barnizadas cromo brillante y epoxi blanco /
Sobres + encimera y costados armario: melamina wengé
oscuro / Puertas armario: melamina wengué oscuro y
cristal templado satinado / Cajonera: melamina blanco





Gambe: verniciate cromo lucido e epox bianco / **Piani + top e fianchi armadio:** melaminico wengé scuro / **Ante armadio:** melaminico wengé scuro e vetro temperato satinato / **Cassetiera:** melaminico bianco

Legs: polished chrome and white epoxy paint finish / Closet shelves, top and sides: Dark wenge laminate / Closet doors: Dark wenge laminate and satin-finished glass / Chest of drawers: white laminate

Piètements: laqués chrome brillant et époxy blanc / Plateaux + top et côtés armoire: mélaminé wengé foncé / Portes armoire: mélaminé wengé foncé et verre trempé satiné / Caisson: mélaminé blanc

Beine: Glanzverchromt und Pulverbeschichtung Weiß / Tischplatten + Abdeckplatte und Seiten Schrank: Melamin Wengé dunkel / Türen Schrank: Melamin wengé dunkel und mattiertes temperiertes Glas / Container: Melamin Weiß

Poten: gevefd glanzend chroom en wit epoxy / Bladen + top en zijpanelen kast: melamine donker wengé / Kast deuren: melamine donker wengé en gesatineerd gehard glas / Ladekast: wit melamine

Patas: barnizadas cromo brillante y epoxi blanco / Sobres + encimera y costados armario: melamina wengé oscuro / Puertas armario: melamina wengué oscuro y cristal templado satinado / Cajonera: melamina blanco



Gambe: verniciate cromo lucido e epox bianco / **Piani:** melaminico wengé scuro / **Top access:** cromo lucido

Legs: polished chrome and white epoxy paint finish / Tops: dark wenge laminate / Top access: polished chrome finish

Piètements: laqués chrome brillant et époxy blanc / Plateaux: mélaminé wengé foncé / Top-access: chrome brillant

Beine: Glanzverchromt und Pulverbeschichtung Weiß / Tischplatten: Melamin Wengé dunkel / Top Access: Glanzverchromt

Poten: gevefd glanzend chroom en wit epoxy / Bladen: melamine donker wengé / Toegang bovenaan: glanzend chroom

Patas: barnizadas cromo brillante y epoxi blanco / Sobres: melamina wengé oscuro / Acceso superior: cromo brillante



Gambe: verniciate epox bianco / Piani: melaminico bianco / Muretto e mobile con ante scorrevoli: melaminico bianco / Top, fianchi e ante armadi: melaminico bianco

Legs: white epoxy paint finish / Tops: white laminate / Wall and cabinet with sliding doors: white laminate / Closet top, sides and doors: white laminate

Piètements: laqués epoxy blanc / Plateaux: mélaminé blanc / Piètement plein et meuble avec portes coulissantes: mélaminé blanc / Top, côtés et portes armoires: mélaminé blanc

Beine: Pulverbeschichtung Weiß / Tischplatten: Melamin Weiß / Wange und Möbel mit Schiebetüren: Melamin Weiß / Abdeckplatte, Seiten und Türen Schränke: Melamin Weiß

Poten: wit geveerd epoxy / Bladen: wit melamine / Wand en meubel met schuifdeuren: wit melamine / Top, zijpanelen en kastdeuren: wit melamine

Patas: barnizadas epoxi blanco / Sobres: melamina blanco / Tabique y mueble con puertas correderas: melamina blanco / Encimera, costados y puertas armarios: melamina blanco





Gambe: verniciate epox bianco / Piani: melaminico bianco / Top, fianchi e ante armadi: melaminico bianco

Legs: white epoxy paint finish / Tops: white laminate / Closet top, sides and doors: white laminate

Piètements: laqués epoxy blanc / Plateaux: mélaminé blanc / Top, côtés et portes armoires: mélaminé blanc

Beine: Pulverbeschichtung Weiß / Tischplatten: Melamin Weiß / Abdeckplatte, Seiten und Türen Schränke: Melamin Weiß

Poten: wit gevefd epoxy / Blad: wit melamine / Top, zijpanelen en kastdeuren: wit melamine

Patas: barnizadas epoxi blanco / Sobres: melamina blanco / Encimera, costados y puertas armarios: melamina blanco



Gambe: verniciate epox bianco / Piano: melaminico bianco

Legs: white epoxy paint finish / Top: white laminate

Piètements: laqués epoxy blanc / Plateau: mélaminé blanc

Beine: Pulverbeschichtung Weiß / Tischplatte: Melamin Weiß

Poten: wit gevefd epoxy / Blad: wit melamine

Patas: barnizadas epoxi blanco / Sobre: melamina blanco



winglet[™]
operative

Gambe: verniciate epox bianco / **Piani:** melaminico rovere naturale / **Cassettiere e vertical file:** melaminico bianco / **Schermi:** tessuto Lucia - Blu Martinique / **Top, fianchi e ante armadi:** melaminico bianco

Legs: white epoxy paint finish / **Tops:** natural oak laminate / **Chest of drawers and vertical file:** white laminate / **Screens:** Lucia fabric - Blue Martinique / **Closet top, sides and doors:** white laminate

Piètements: laqués epoxy blanc / **Plateaux:** mélaminé chêne naturel / **Caissons et classeur vertical:** mélaminé blanc / **Écrans:** tissu Lucia - Bleu Martinique / **Top, côtés et portes armoires:** mélaminé blanc

Beine: Pulverbeschichtung Weiß / **Tischplatten:** Melamin Eiche Natur / **Container und Vertical File:** Melamin Weiß / **Schirme:** Stoff Lucia - Blau Martinique / **Abdeckplatte, Seiten und Türen Schränke:** Melamin Weiß

Poten: wit geveerd epoxy / **Bladen:** melamine eikenhout natuur / **Ladekasten en hangmappen:** wit melamine / **Schermen:** stof Lucia - Blauw - Martinique / **Top, zijpanelen en kastdeuren:** wit melamine

Patas: barnizadas epoxi blanco / **Sobres:** melamina roble natural / **Cajoneras y archivador vertical:** melamina blanco / **Pantallas:** tejido Lucia - Azul Martinique / **Encimera, costados y puertas armarios:** melamina blanco





Gambe e passacavi: verniciati epox bianco / Piani: melaminico rovere naturale / Cassettiere: melaminico bianco / Schermi: tessuto Lucia - Mattone Jamaica

Legs and cable holders: white epoxy paint finish / Tops: natural oak laminate / Chest of drawers: white laminate / Screens: Lucia fabric - Jamaica brick colour

Piètements et passe-câbles: laqués epoxy blanc / Plateaux: mélaminé chêne naturel / Plateaux: mélaminé chêne naturel / Caissons: mélaminé blanc / Écrans: tissu Lucia - Brique Jamaica

Beine und Kabeldurchführungen: Pulverbeschichtung Weiß / Tischplatten: Melamin Eiche Natur / Container: Melamin Weiß / Schirme: Stoff Lucia - Ziegelrot Jamaica

Poten en kabeldoorvoer: wit geveerd epoxy / Bladen: melamine eikenhout natuur / Ladekasten: wit melamine / Schermen: stof Lucia - Baksteen - Jamaica

Patas y pasacables: barnizados epoxi blanco / Sobres: melamina roble natural / Cajoneras: melamina blanco / Pantallas: tejido Lucia - Pardo cobre Jamaica

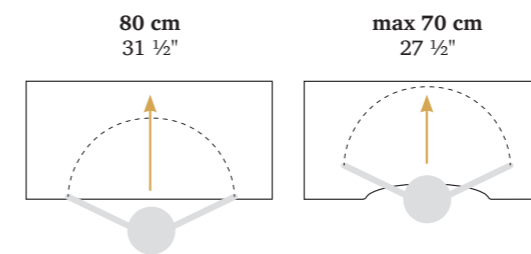

Scrivania

Desktop - Bureau - Schreibtisch - Schrijftafel - Escritorio

Scrivania ERGO

Ergo desktop - Bureau Ergo - Schreibtisch ERGO - Schrijftafel ERGO - Escritorio Ergo

Gambe: verniciate epox bianco / Piani: melaminico rovere naturale / Vertical file: melaminico bianco / Schermi: tessuto Lucia - Petrolio Windjammer / Top, fianchi e ante armadi: melaminico bianco

Legs: white epoxy paint finish / Tops: natural oak laminate / Vertical file: white laminate / Screens: Lucia fabric - Windjammer petroleum colour / Closet top, sides and doors: white laminate

Piètements: laqués epoxy blanc / Plateaux: mélaminé chêne naturel / Classeur vertical: mélaminé blanc / Écrans: tissu Lucia - Pétrole Windjammer / Top, côtés et portes armoires: mélaminé blanc

Beine: Pulverbeschichtung Weiß / Tischplatten: Melamin Eiche Natur / Vertical File: Melamin Weiß / Schirme: Stoff Lucia - Petroleum Blau Windjammer / Abdeckplatte, Seiten und Türen Schränke: Melamin Weiß

Poten: wit geveerd epoxy / Bladen: melamine eikenhout natuur / Hangmappen: wit melamine / Schermen: stof Lucia - Petroleum - Windjammer / Top, zijpanelen en kastdeuren: wit melamine

Patas: barnizadas epoxi blanco / Sobres: melamina roble natural / Archivador vertical: melamina blanco / Pantallas: tejido Lucia - Petróleo Windjammer / Encimera, costados y puertas armarios: melamina blanco

winglet[™] operative

Gambe: verniciate epox bianco / **Piani:** melaminico bianco / **Schermi:** tessuto Xpress - Giallo Primavera e Lucia - Celeste Arcibo / **Scocca e top armadi:** melaminico bianco / **Ante armadi:** melaminico tortora / **Vertical file:** melaminico bianco

Legs: white epoxy paint finish / **Tops:** white laminate / **Screens:** Xpress fabric - Spring yellow and Lucia - Arcibo light blue / **Closet body and top:** white laminate / **Closet doors:** turtledove laminate / **Vertical file:** white laminate

Piètements: laqués epoxy blanc / **Plateaux:** mélaminé blanc / **Écrans:** tissu Xpress - Jaune Printemps et Lucia - Bleu ciel Arcibo / **Structure et top armoires:** mélaminé blanc / **Portes armoires:** mélaminé tourterelle / **Classeur vertical:** mélaminé blanc

Beine: Pulverbeschichtung Weiß / **Tischplatten:** Melamin Weiß / **Schirme:** Stoff Xpress - Frühling Gelb und Lucia - Hellblau Arcibo / **Unterbau und Abdeckplatte Schränke:** Melamin Weiß / **Türen Schränke:** Melamin Turteltaube / **Vertical File:** Melamin Weiß

Poten: wit geverfd epoxy / **Bladen:** wit melamine / **Schermen:** stof Xpress - Lentegeel en Lucia - Hemelsblauw - Arcibo / **Frame en top kasten:** wit melamine / **Kastdeuren:** melamine tortelduif / **Hangmappen:** wit melamine

Patas: barnizadas epoxi blanco / **Sobres:** melamina blanco / **Pantallas:** tejido Xpress - Amarillo Primavera y Lucia - Celeste Arcibo / **Armazón y encimera armarios:** melamina blanco / **Puertas armarios:** melamina tortola / **Archivador vertical:** melamina blanco



winglet operative



Gambe: verniciate epox bianco / **Piani, modesty panel e cassettiere:** melaminico bianco / **Schermi:** laccato opaco tortora e tessuto Xpress - Verde sottobosco / **Ubi:** melaminico bianco / **Ante Ubi:** metacrilato grigio

Legs: white epoxy paint finish / **Tops, modesty panel and chest of drawers:** white laminate / **Screens:** matte lacquered turtledove colour and Xpress fabric - Underbush green / **Ubi:** white laminate / **Ubi doors:** grey methacrylate

Piètements: laqués epoxy blanc / **Plateaux, voile de fond et caissons:** mélaminé blanc / **Écrans:** laqué mat tourterelle et tissu Xpress - Vert sous-bois / **Ubi:** mélaminé blanc / **Portes Ubi:** méthacrylate gris

Beine: Pulverbeschichtung Weiß / **Tischplatten, Knieraumblende und Container:** Melamin Weiß / **Schirme:** Mattweiß lackiert Torteltaube und Stoff Xpress - Unterholz Grün / **Ubi:** Melamin Weiß / **Türen Ubi:** Methacrylat Grau

Poten: wit geveerd epoxy / **Bladen, knieschotten en ladekasten:** wit melamine / **Schermen:** mat gelakt tortelduif en stof Xpress - Bosgrond-groen / **Ubi:** wit melamine / **Deuren Ubi:** grijs methacrylaat

Patas: barnizadas epoxi blanco / **Sobres, panel frontal y cajoneras:** melamina blanco / **Pantallas:** lacado mate tortola y tejido Xpress - Verde sotobosque / **Ubi:** melamina blanco / **Puertas Ubi:** metacrilato gris



winglet operative

Gambe: verniciate epox bianco / **Piani:** melaminico bianco / **Cassettiere, vertical file e mobile con ante scorrevoli:** melaminico bianco / **Armadi:** melaminico bianco / **Schermi:** tessuto Stay - Blu Avio

Legs: white epoxy paint finish / **Tops:** white laminate / **Chests of drawers, vertical files and cabinet with sliding doors:** white laminate / **Closets:** white laminate / **Screens:** Stay fabric - Avio blue

Piètements: laqués epoxy blanc / **Plateaux:** mélaminé blanc / **Caissons, classeur vertical et meuble avec portes coulissantes:** mélaminé blanc / **Armoires:** mélaminé blanc / **Écrans:** tissu Stay - Blu Aviation

Beine: Pulverbeschichtung Weiß / **Tischplatten:** Melamin Weiß / **Container, Vertical File und Möbel mit Schiebetüren:** Melamin Weiß / **Schränke:** Melamin Weiß / **Schirme:** Stoff Stay - Avio Blau

Poten: wit geveerd epoxy / **Bladen:** wit melamine / **Ladekasten, hangmappen en meubel met schuifdeuren:** wit melamine / **Kasten:** wit melamine / **Schermen:** stof Stay - Avio-blauw

Patas: barnizadas epoxi blanco / **Sobres:** melamina blanco / **Cajoneras, archivador vertical y mueble con puertas correderas:** melamina blanco / **Armarios:** melamina blanco / **Pantallas:** tejido Stay - Azul colombiano



Gambe: verniciate epox bianco / Piani: melaminico bianco / Schermi: tessuto Stay - Blu Avio

Legs: white epoxy paint finish / Tops: white laminate / Screens: Stay fabric - Avio blue

Piètements: laqués epoxy blanc / Plateaux: mélaminé blanc / Écrans: tissu Stay - Blu Aviation

Beine: Pulverbeschichtung Weiß / Tischplatten: Melamin Weiß / Schirme: Stoff Stay - Avio Blau

Poten: wit gevefd epoxy / Bladen: wit melamine / Schermen: stof Stay - Avio-blauw

Patas: barnizadas epoxi blanco / Sobres: melamina blanco / Pantallas: tejido Stay - Azul colombino

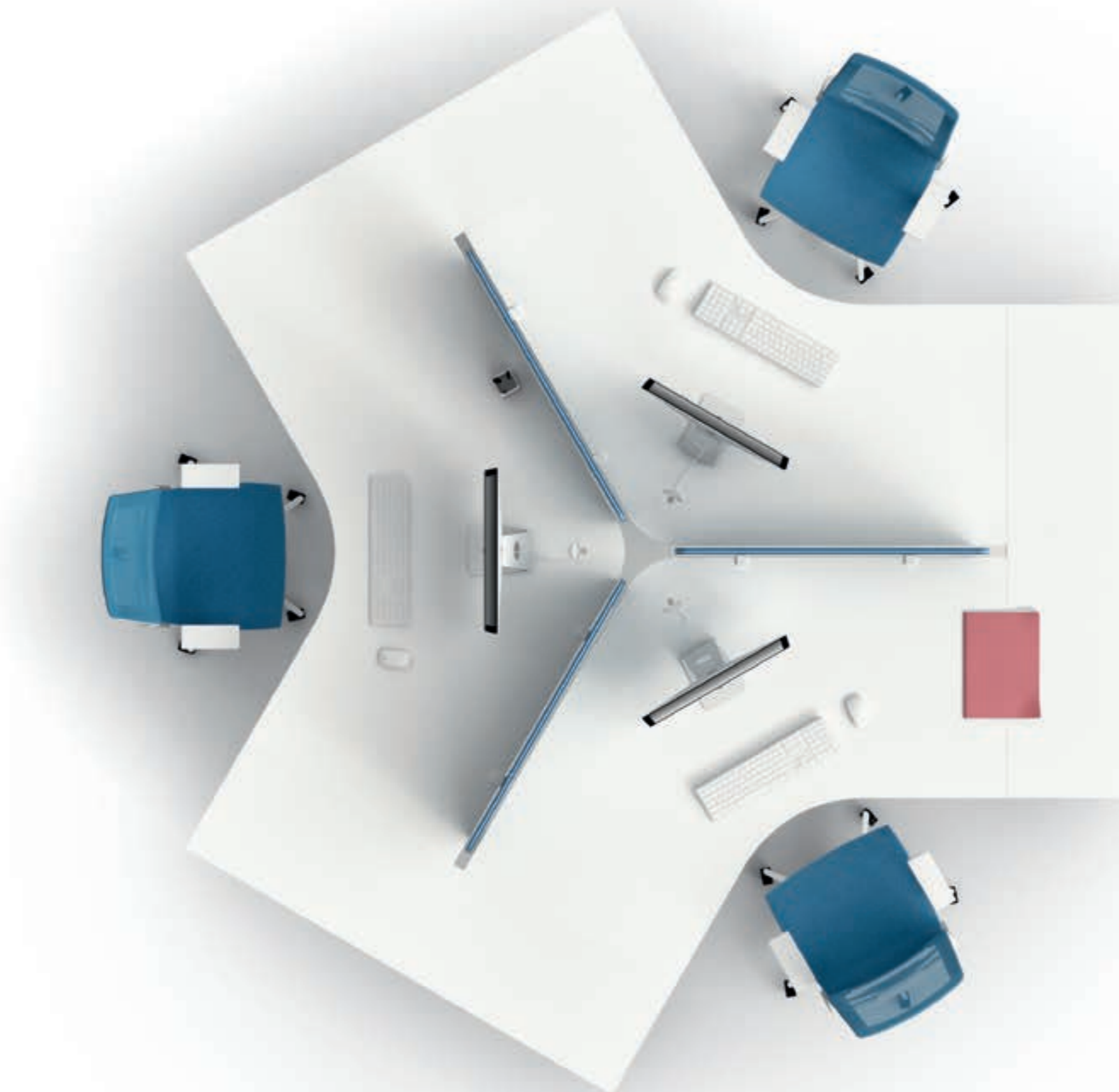

Gambe: verniciate epox bianco / **Piani:** melaminico bianco / **Mobili Eko e armadi:** melaminico bianco / **Schermo:** tessuto Xpress - Giallo primavera

Legs: white epoxy paint finish / Tops: white laminate / Eko cabinets and closets: white laminate / Screen: Xpress fabric - Spring yellow

Piètements: laqués epoxy blanc / Plateaux: mélaminé blanc / Meubles Eko et armoires: mélaminé blanc / Écrans: tissu Xpress - Jaune printemps

Beine: Pulverbeschichtung Weiß / Tischplatten: Melamin Weiß / Möbel Eko und Schränke: Melamin Weiß / Schirm: Stoff Xpress - Frühling Gelb

Poten: wit gevefd epoxy / Bladen: wit melamine / Meubels Eko en kasten: wit melamine / Scherm: stof Xpress - Lentegeel

Patas: barnizadas epoxi blanco / Sobres: melamina blanco / Muebles Eko y armarios: melamina blanco / Pantalla: tejido Xpress - Amarillo primavera



Gambe: verniciate epox bianco / **Piani, cassettiere e vertical file:** melaminico bianco / **Schermi:** tessuto Lucia - Celeste Arcibo e Xpress - Giallo Primavera / **Scocca e top armadi:** melaminico bianco / **Ante mobili e armadi:** melaminico tortora

Legs: white epoxy paint finish / Tops, chests of drawers and vertical file: white laminate / Screens: Lucia fabric - Arcibo light blue and Xpress - Spring yellow / Closet body and top: white laminate / Cabinet and closet doors: turtledove laminate

Piètements: laqués epoxy blanc / **Plateaux, caissons et classeur vertical:** mélaminé blanc / **Écrans:** tissu Lucia - Bleu Arcibo et Xpress - Jaune Printemps / **Structure et top armoires:** mélaminé blanc / **Portes meubles et armoires:** mélaminé tourterelle

Beine: Pulverbeschichtung Weiß / **Tischplatten, Container und Vertical File:** Melamin Weiß / **Schirme:** Stoff Lucia - Hellblau Arcibo und Xpress - Frühling Gelb / **Unterbau und Abdeckplatte Schränke:** Melamin Weiß / **Türen Möbel und Schränke:** Melamin Turteltaube

Poten: wit geveerd epoxy / **Bladen, ladekasten en hangmappen:** wit melamine / **Schermen:** stof Lucia - Hemelsblauw - Arcibo en Xpress - Lentegeel / **Deuren meubels en kasten:** melamine tortelduif

Patas: barnizadas epoxi blanco / **Sobres, cajoneras y archivador vertical:** melamina blanco / **Pantallas:** tejido Lucia - Celeste Arcibo y Xpress - Amarillo Primavera / **Armazón y encimera armarios:** melamina blanco / **Puertas muebles y armarios:** melamina tortola





Gambe: verniciate epox bianco / Piani, cassettiere e vertical file: melaminico bianco / Schermi: tessuto Lucia - Celeste Arcibo / Mobili con ante scorrevoli: melaminico bianco e tortora

Legs: white epoxy paint finish / Tops, chests of drawers and vertical file: white laminate / Screens: Lucia fabric - Arcibo light blue / Cabinet with sliding doors: white and turtledove laminate

Piètements: laqués epoxy blanc / Plateaux, caissons et classeur vertical: mélaminé blanc / Écrans: tissu Lucia - Bleu ciel Arcibo / meuble avec portes coulissantes: mélaminé blanc et tourterelle

Beine: Pulverbeschichtung Weiß / Tischplatten, Container und Vertical File: Melamin Weiß / Schirme: Stoff Lucia - Hellblau Arcibo / Möbel mit Schiebetüren: Melamin Weiß und Turteltaube

Poten: wit gevefd epoxy / Bladen, ladekasten en hang-mappen: wit melamine / Schermen: stof Lucia - Hemelsblauw - Arcibo / Meubel met schuifdeuren: wit en tortelduif melamine

Patatas: barnizadas epoxi blanco / Sobres, cajoneras y archivador vertical: melamina blanco / Pantallas: tejido Lucia - Celeste Arcibo / Mueble con puertas correderas: melamina blanco y tortola

Gambe: verniciate epox bianco / Piani e cassettiere: melaminico bianco / Schermi: tessuto Lucia - Celeste Arcibo

Legs: white epoxy paint finish / Tops and chests of drawers: white laminate / Screens: Lucia fabric - Arcibo light blue

Piètements: laqués epoxy blanc / Plateaux et caissons: mélaminé blanc / Écrans: tissu Lucia - Bleu ciel Arcibo

Beine: Pulverbeschichtung Weiß / Tischplatten und Container: Melamin Weiß / Schirme: Stoff Lucia - Hellblau Arcibo

Poten: wit gevefd epoxy / Bladen en ladekasten: wit melamine / Schermen: stof Lucia - Hemelsblauw - Arcibo

Patatas: barnizadas epoxi blanco / Sobres y cajoneras: melamina blanco / Pantallas: tejido Stay - Azul colombino



Gambe: verniciate epox bianco / **Piani:** melaminico bianco / **Muretto, M10 e vertical file:** melaminico bianco / **Schermi:** tessuto Puma – Grigio scuro

Legs: white epoxy paint finish / **Tops:** white laminate / **Wall, M10 and vertical file:** white laminate / **Screens:** Puma fabric - Dark grey

Piètements: laqués epoxy blanc / **Plateaux:** mélaminé blanc / **Pièment plein, M10 et classeur vertical:** mélaminé blanc / **Écrans:** tissu Puma – Gris foncé

Beine: Pulverbeschichtung Weiß / **Tischplatten:** Melamin Weiß / **Wange, M10 und Vertical File:** Melamin Weiß / **Schirme:** Stoff Puma – Dunkelgrau

Poten: wit gevefd epoxy / **Bladen:** wit melamine / **Wand, M10 en hangmappen:** wit melamine / **Schermen:** stof Puma – Donkergrijs

Patas: barnizadas epoxi blanco / **Sobres:** melamina blanco / **Tabique, M10 y archivador vertical:** melamina blanco / **Pantallas:** tejido Puma – Gris oscuro



Gambe: verniciate epox bianco / Piani: melaminico bianco / Pannello laterale e M10: melaminico bianco / Schermi: tessuto Xpress - Giallo primavera

Legs: white epoxy paint finish / Tops: white laminate / Side panel and M10: white laminate / Screens: Xpress fabric - Spring yellow

Piètements: laqués epoxy blanc / Plateaux: mélaminé blanc / Panneau latéral et M10: mélaminé blanc / Écrans: tissu Xpress - Jaune printemps

Beine: Pulverbeschichtung Weiß / Tischplatten: Melamin Weiß / Seitenpaneel und M10: Melamin Weiß / Schirme: Stoff Xpress - Frühling Gelb

Poten: wit gevefd epoxy / Bladen: wit melamine / Zijpaneel en M10: wit melamine / Schermen: stof Xpress - Lentegel

Patas: barnizadas epoxi blanco / Sobres: melamina blanco / Tablero lateral y M10: melamina blanco / Pantallas: tejido Xpress - Amarillo primavera

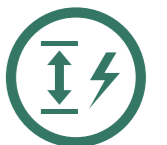

Gambe: verniciate epox bianco / **Piani:** melaminico rovere naturale / **Muretto e vertical file:** melaminico bianco / **Schermi:** tessuto Lucia – Blu Martinique

Legs: white epoxy paint finish / Tops: natural oak laminate / Wall and vertical file: white laminate / Screens: Lucia fabric - Martinique blue

Piètements: laqués epoxy blanc / Plateaux: mélaminé chêne naturel / Piètement plein et classeur vertical: mélaminé blanc / Écrans: tissu Lucia – Bleu Martinique

Beine: Pulverbeschichtung Weiß / Tischplatten: Melamin Eiche Natur / Wange und Vertical File: Melamin Weiß / Schirme: Stoff Lucia – Blau Martinique

Poten: wit gevefd epoxy / Bladen: melamine eikenhout natuur / Wand en hangmappen: wit melamine / Schermen: stof Lucia – Blauw - Martinique

Patas: barnizadas epoxi blanco / Sobres: melamina roble natural / Tabique y archivador vertical: melamina blanco / Pantallas: tejido Lucia – Azul Martinique

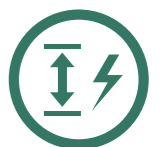

winglet[™]
meeting

Gambe: verniciate epox bianco / **Piani, top e fianchi armadio:** melaminico rovere naturale / **Ante armadio:** melaminico rovere naturale e vetro temperato satinato

Legs: white epoxy paint finish / Closet shelves, top and sides: natural oak laminate / Closet doors: natural oak laminate and satin-finished tempered glass

Piètements: laqués epoxy blanc / Plateaux, top et côtés armoire: mélaminé chêne naturel / Portes armoire: mélaminé chêne naturel et verre trempé satiné

Beine: Pulverbeschichtung Weiß / Tischplatten, Abdeckplatte und Seiten Schrank: Melamin Eiche Natur / Türen Schrank: Melamin Eiche Natur und mattiertes temperiertes Glas

Poten: wit geveerd epoxy / Bladen, top en zijpanelen kast: melamine eikenhout natuur / Kastdeuren: melamine eikenhout natuur en gesatineerd gehard glas

Patas: barnizadas epoxi blanco / Sobres, encimera y costados armario: melamina roble natural / Puertas armario: melamina roble natural y cristal templado satinado



Gambe: verniciate epox bianco / **Piani, top e fianchi**
armadio: melaminico bianco / **Ante armadio:** melaminico bianco e vetro temperato satinato

Legs: white epoxy paint finish / Closet shelves, top and sides: white laminate / Closet doors: white laminate and satin-finished tempered glass

Piètements: laqués epoxy blanc / Plateaux, top et côtés
armoire: mélaminé blanc / Portes armoire: mélaminé blanc et verre trempé satiné

Beine: Pulverbeschichtung Weiß / Tischplatten, Abdeckplatte und Seiten Schrank: Melamin Weiß / Türen Schrank: Melamin Weiß und mattiertes temperiertes Glas

Poten: wit geveerd epoxy / Bladen, top en zijpanelen
kast: wit melamine / Kastdeuren: wit melamine en gesatineerd gehard glas

Patas: barnizadas epoxi blanco / Sobres, encimera y costados armario: melamina blanco / Puertas armario: melamina blanco y cristal templado satinado



Gambe: verniciate epox bianco / Piani: melaminico bianco / Flipper: melaminico bianco

Legs: white epoxy paint finish / Tops: white laminate / Flipper: white laminate

Piètements: laqués epoxy blanc / Plateaux: mélaminé blanc / Flipper: mélaminé blanc

Beine: Pulverbeschichtung Weiß / Tischplatten: Melamin Weiß / Flipper: Melamin Weiß

Poten: wit geverfd epoxy / Bladen: wit melamine / Flipper: wit melamine

Patas: barnizadas epoxi blanco / Sobres: melamina blanco / Flipper: melamina blanco





**Gambe: verniciate epox bianco /
Piani: melaminico bianco**

Legs: white epoxy paint finish /
Tops: white laminate

Piètements: laqués epoxy blanc /
Plateaux: mélaminé blanc

Beine: Pulverbeschichtung Weiß /
Tischplatten: Melamin Weiß

Poten: wit gevefd epoxy /
Bladen: wit melamine

Patas: barnizadas epoxi blanco /
Sobres: melamina blanco

**Gambe: verniciate epox bianco /
Piani: melaminico bianco**

Legs: white epoxy paint finish /
Tops: white laminate

Piètements: laqués epoxy blanc /
Plateaux: mélaminé blanc

Beine: Pulverbeschichtung Weiß /
Tischplatten: Melamin Weiß

Poten: wit gevefd epoxy /
Bladen: wit melamine

Patas: barnizadas epoxi blanco /
Sobres: melamina blanco



**Comunicare, condividere,
partecipare.**

Communicating, sharing,
participating.

Communiquer, partager,
participer.

Kommunizieren, teilen,
teilnehmen.

Communiceren, delen,
deelnemen.

Comunicar, compartir,
participar.



Gambe: verniciate epox bianco / **Piani:** melaminico bianco / **Domomag e scaffale:** melaminico bianco, rosso rubino e grigio granito; **parti metalliche** verniciate epox bianco e grigio granito

Legs: white epoxy paint finish / **Tops:** white laminate / **Domomag and shelf:** white, ruby red and granite grey laminate; **metal parts:** white and granite grey epoxy paint finish

Piètements: laqués epoxy blanc / **Plateaux:** mélaminé blanc / **Domomag et rayonnage:** mélaminé blanc, rouge rubis et gris granit ; **parties métalliques** laquées epoxy blanc et gris granit

Beine: Pulverbeschichtung Weiß / **Tischplatten:** Melamin Weiß / **Domomag und Regal:** Melamin Weiß, Rubinrot und Granitgrau; **Metallteile** mit Pulverbeschichtung Weiß und Granitgrau

Poten: wit geveerd epoxy / **Bladen:** wit melamine / **Domomag en boekenrek:** wit melamine, robijnrood en granietgrijs; **metalen onderdelen** wit en granietgrijs geveerd epoxy

Patas: barnizadas epoxi blanco / **Sobres:** melamina blanco / **Domomag y estantería:** melamina blanco, rojo rubí y gris granito; **partes metálicas** barnizadas epoxi blanco y gris granito





TIPO A - TYPE A - TYPE A - TYP A - TYPE A - TIPO A
elettrico - electrical - électrique - elektrisch - elektrisch - eléctrico

Gambe: verniciate epox bianco / **Piani:** melaminico bianco / **Domomag:** melaminico bianco, rosso rubino e grigio granito; **parti metalliche verniciate epox bianco e grigio granito**

Legs: white epoxy paint finish / **Tops:** white laminate / **Domomag:** white, ruby red and granite grey laminate; **metal parts:** white and granite grey epoxy paint finish

Prètements: laqués epoxy blanc / **Plateaux:** mélaminé blanc / **Domomag:** mélaminé blanc, rouge rubis et gris granit ; **parties métalliques laquées epoxy blanc et gris granit**

Beine: Pulverbeschichtung Weiß / **Tischplatten:** Melamin Weiß / **Domomag:** Melamin Weiß, Rubinrot und Granitgrau; **Metallteile mit Pulverbeschichtung Weiß und Granitgrau**

Poten: wit gevefd epoxy / **Bladen:** wit melamine / **Domomag:** wit melamine, robijnrood en granietgrijs; **metalen onderdelen wit en granietgrijs gevefd epoxy**

Patas: barnizadas epoxi blanco / **Sobres:** melamina blanco / **Domomag:** melamina blanco, rojo rubí y gris granito; **partes metálicas barnizadas epoxi blanco y gris granito**



COMPOSIZIONI DOMOMAG, SU RUOTE - Domomag arrangements, with castors
Compositions Domomag, sur roulettes - Domomag-Kombinationen, auf Rollen -
Combinaties Domomag, op wielen - Composiciones Domomag, sobre ruedas

DU.0805.2A

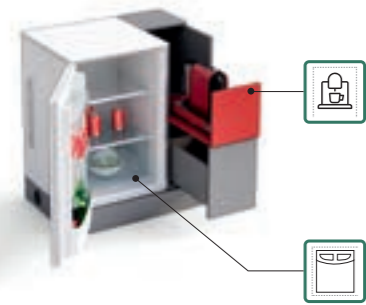

DU.0805.2B

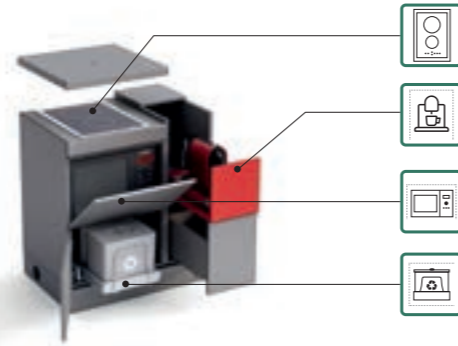

DU.1305.3A

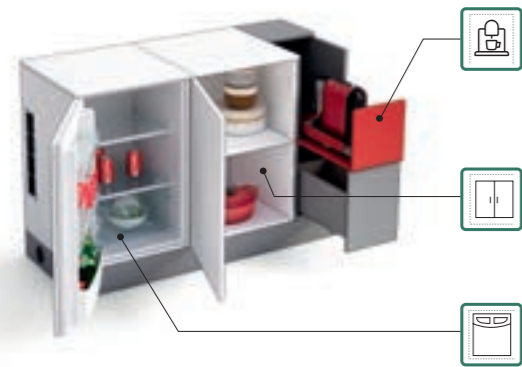



DU.1305.3B



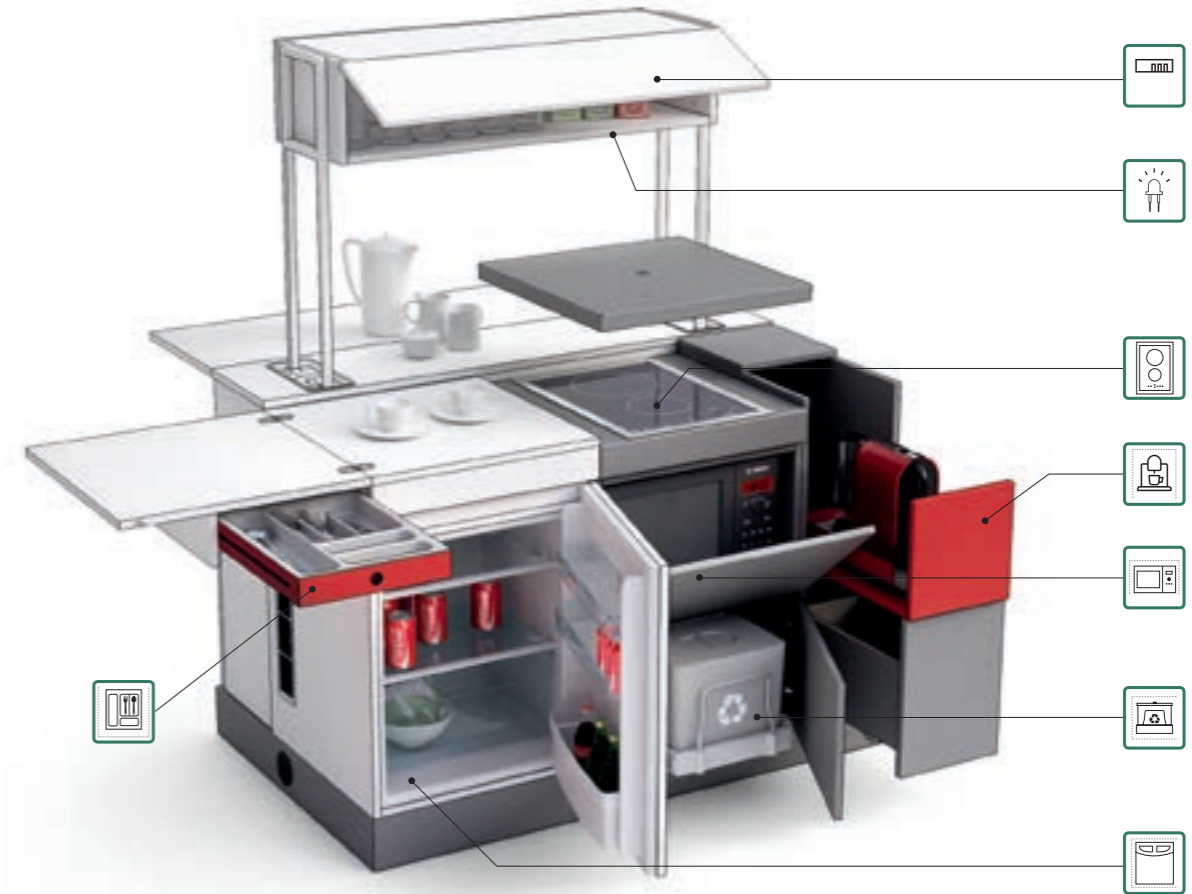

DU.1308.5A





 **Vano predisposto per macchinetta caffè**
Compartment To accommodate a coffee machine
Niche avec predisposition pour machine à café
Kaffeemaschinentach
Compartment voor plaatsing koffiemachine
Hueco predispueto para maquina de café

 **Vano predisposto per piano cottura**
Compartment to accommodate installation of an electric Hob
Niche avec predisposition pour plaque de cuisson
Platte mit Aufnahme für Kochfelder
Compartment voor plaatsing kookplaat
Orificio predispueto para placa de cocción

 **2 contenitori porta rifiuti compresi**
Two waste pipes included
2 rangements pour déchets inclus
2 Abfallbehälter inklusive
2 afvalbakken inbegrepen
2 recipientes para residuos incluidos

 **Vano predisposto per frigo**
Compartment To accommodate a refrigerator
Niche avec predisposition pour frigo
Kühlschrank-Einbaufach
Compartment voor plaatsing koelkast
Cavidad predispueto para frigorífico

 **Vano predisposto per microonde**
Compartment to accommodate a Microwave
Niche avec predisposition pour four à micro-ondes
Mikrowellen-Einbaufach
Compartment voor plaatsing magnetron
Abertura para horno de microondas

 **Cassetto portaposate compreso**
Drawer For cutlery included
Tiroir pour couverts inclus
Besteckensatz inklusive
Besteklade inbegrepen
Cajón portacubiertos incluido

 **Vano per dispensa**
Pantry Compartment
Niche pour garde-manger
Vorrätfach
Pantry compartment
Cavidad para dispensa

 **Fondo salvagoccia compreso**
Water plate protection included
Plaque de protection projections d'eau
Inklusive Nässechutzverkleidung aus Metall
Spatwater plaat inbegrepen
Fondo salvagota incluido

 **3 cassetini porta spezie compresi**
3 holding spices drawers included
3 tiroirs porte épices inclus
Inklusive 3 Mini-Schübe
3 kleine kruidenladen inbegrepen
3 cajones porta especias incluidos

 **Pensile con possibilità di inserimento scolapiatti**
Wall unit with optional dish rack
Meuble suspendu avec égouttoir optionnel
Hängeschrank mit Einbaumöglichkeit eines Abtropfgitters
Wand met optioneel borderek
Pénsil con posibilidad de inserción de escurreplatos

 **Lavello + sifone + miscelatore monocomando compresi**
Sink Complete with Plughole and water taps included
Evier+siphon+mitigeur inclus
Inklusive Spülbecken mit Siphon und Einhebelmischbatterie
Wasbak compleet met kraan en afvoer inbegrepen
Fregadero + sifón + mezclador monomando incluidos

 **4 mini contenitori**
4 small compartments
4 petits rangements
4 kleine Leerablagefächer
4 smalle elementen
4 mini contenedores

 **Optional: Versacharger**
Optional: wireless charger
Option: chargeur sans fil
Optional: Wireless-Ladegerät
Optioneel: draadloze lader
Optional: Versacharger (cargador wireless)

 **Ruote**
Castors
Roulettes
Laufrollen
Wielen
Ruedas

 **Led compreso**
Led light included
Led inclus
Inklusive LED-Beleuchtung
LED licht inbegrepen
Led incluido

 **Vano tecnico ispezionabile**
Inspectionable technical compartment
Niche technique inspectionnable
Inspezierbares Kabelfach
Inspeziebaar technisch element
Vano tecnico inspeccionable

winglet™
**composizioni
alternative**

Alternative layouts

Compositions alternatives

Alternativkombinationen

Alternatieve combinatie

Composiciones alternativas

Alcuni esempi di possibili configurazioni - Some examples of possible layouts - Voici quelques exemples de configurations possibles - Einige Beispiele von möglichen Konfigurationen - Een aantal voorbeelden van mogelijke configuraties - Algunos ejemplos de configuraciones posibles

Per una più completa visione della collezione, consultare il listino
Pour un meilleur aperçu de la collection, veuillez consulter la liste des prix
Om de volledige collectie te raadplegen, zie de lijst

To view the collection in more detail, please refer to our price list
Eine komplette Ansicht der Kollektion finden Sie in der Preisliste
Para ver más detalladamente la colección, consultar la tarifa



		cm	inch
	Scrivania Desk Bureau Schreibtisch Bureau Escritorio	L. 80÷200 P. 60÷80 H. 74	W. 31 1/2"÷78 3/4" D. 23 3/4"÷31 1/2" H. 29"
	Scrivania Desk Bureau Schreibtisch Bureau Escritorio	L. 160÷200 P. 80 H. 74	W. 63"÷78 3/4" D. 31 1/2" H. 29"
	Scrivania Desk Bureau Schreibtisch Bureau Escritorio	L. 180 P. 90 H. 74	W. 70 3/4" D. 35 1/2" H. 29"
	Scrivania con cassetiera portante CM.0408.M4 Desk with drawer unit CM.0408.M4 Bureau avec caisson portant CM.0408.M4 Schreibtisch mit tragendem Schubladenelement CM.0408.M4 Bureau met dragend ladenblok CM.0408.M4 Escritorio con cajonera portante CM.0408.M4	L. 120÷200 P. 60÷80 H. 74	W. 47 1/4"÷78 3/4" D. 23 3/4"÷31 1/2" H. 29"
	Scrivania con cassetiera portante CM.0408.M3 Desk with drawer unit CM.0408.M3 Bureau avec caisson portant CM.0408.M3 Schreibtisch mit tragendem Schubladenelement CM.0408.M3 Bureau met dragend ladenblok CM.0408.M3 Escritorio con cajonera portante CM.0408.M3	L. 120÷200 P. 60÷80 H. 74	W. 47 1/4"÷78 3/4" D. 23 3/4"÷31 1/2" H. 29"
	Scrivania con vertical file Sx CM.0408.ES Desk with left vertical file CM.0408.ES Bureau avec classeurs verticaux gauche CM.0408.ES Schreibtisch mit Vertical File links CM.0408.ES Bureau met vertical file links CM.0408.ES Escritorio con archivadores verticales izquierdo CM.0408.ES	L. 120÷200 P. 60÷80 H. 74	W. 47 1/4"÷78 3/4" D. 23 3/4"÷31 1/2" H. 29"
	Scrivania con vertical file Sx CM.1108.ES e top Desk with left vertical file CM.1108.ES and top Bureau avec classeurs verticaux gauche CM.1108.ES et dessus Schreibtisch mit Vertical File links CM.1108.ES und Top Bureau met vertical file links CM.1108.ES en top Escritorio con archivadores verticales izquierdo CM.1108.ES y sobre	L. 80÷200 P. 80 H. 74	W. 31 1/2"÷78 3/4" D. 31 1/2" H. 29"







		cm	inch
	Scrivania a ponte su mobile di servizio scorrevole Bridge desk on service cabinet Bureau pont sur meuble de service Schreibtisch-Brücke auf Werkboxmodul Brugtafel op dienstmeubel Escritorio puente en mueble de servicio	L. 120÷200 P. 142 H. 74	W. 47 1/4"÷78 3/4" D. 56" H. 29"
	Scrivania a ponte su mobile di servizio Eko BD.1206.C3 Bridge desk on service cabinet EKO BD.1206.C3 Bureau pont sur meuble de service EKO BD.1206.C3 Schreibtisch-Brücke auf Werkboxmodul EKO BD.1206.C3 Brugtafel op dienstmeubel EKO BD.1206.C3 Escritorio puente en mueble de servicio EKO BD.1206.C3	L. 120÷200 P. 142 H. 74	W. 47 1/4"÷78 3/4" D. 56" H. 29"
	Scrivania + dattilo appeso Desk + workwall Bureau + dactylo suspendu Schreibtisch + Hängender Tischmodul Bureau + oplegtafel Escritorio + ala escritorio suspendida	L. 140÷180 P. 160÷200 H. 74	W. 55"÷70 3/4" D. 63"÷78 3/4" H. 29"
	Scrivania + dattilo appeso con cassetiera portante CM.0407.M4 Desk + workwall with drawer unit CM.0407.M4 Bureau + dactylo suspendu avec caisson portant CM.0407.M4 Schreibtisch + Hängender Tischmodul mit tragendem Schubladenelement CM.0407.M4 Bureau + oplegtafel met dragend ladenblok CM.0407.M4 Escritorio + ala escritorio suspendida con cajonera portante CM.0407.M4	L. 140÷180 P. 160÷200 H. 74	W. 55"÷70 3/4" D. 63"÷78 3/4" H. 29"
	Scrivania Desk Bureau Schreibtisch Bureau Escritorio	L. 80÷180 P. 60÷80 H. 74	W. 31 1/2"÷78 3/4" D. 23 3/4"÷31 1/2" H. 29"
	Scrivania Desk Bureau Schreibtisch Bureau Escritorio	L. 160÷180 P. 80 H. 74	W. 63"÷70 3/4" D. 31 1/2" H. 29"
	Scrivania Desk Bureau Schreibtisch Bureau Escritorio	L. 180 P. 90 H. 74	W. 70 3/4" D. 35 1/2" H. 29"

Alcuni esempi di possibili configurazioni - Some examples of possible layouts - Voici quelques exemples de configurations possibles - Einige Beispiele von möglichen Konfigurationen - Een aantal voorbeelden van mogelijke configuraties - Algunos ejemplos de configuraciones posibles

Per una più completa visione della collezione, consultare il listino
Pour un meilleur aperçu de la collection, veuillez consulter la liste des prix
Om de volledige collectie te raadplegen, zie de lijst

To view the collection in more detail, please refer to our price list
Eine komplette Ansicht der Kollektion finden Sie in der Preisliste
Para ver más detalladamente la colección, consultar la tarifa

		cm	inch
	Scrivanía con cassettiera portante CM.0408.M4 Desk with drawer unit CM.0408.M4 Bureau avec caisson portant CM.0408.M4 Schreibtisch mit tragendem Schubladenelement CM.0408.M4 Bureau met dragend ladenblok CM.0408.M4 Escritorio con cajonera portante CM.0408.M4	L. 120÷200 P. 60÷80 H. 74	W. 47 1/4"÷78 3/4" D. 23 3/4"÷31 1/2" H. 29"
	Scrivanía con cassettiera portante CM.0408.M3 Desk with drawer unit CM.0408.M3 Bureau avec caisson portant CM.0408.M3 Schreibtisch mit tragendem Schubladenelement CM.0408.M3 Bureau met dragend ladenblok CM.0408.M3 Escritorio con cajonera portante CM.0408.M3	L. 120÷200 P. 60÷80 H. 74	W. 47 1/4"÷78 3/4" D. 23 3/4"÷31 1/2" H. 29"
	Scrivanía con vertical file Sx CM.0408.ES Desk with left vertical file CM.0408.ES Bureau avec classeurs verticaux gauche CM.0408.ES Schreibtisch mit Vertical File links CM.0408.ES Bureau met vertical file links CM.0408.ES Escritorio con archivadores verticales izquierdo CM.0408.ES	L. 120÷200 P. 60÷80 H. 74	W. 47 1/4"÷78 3/4" D. 23 3/4"÷31 1/2" H. 29"
	Scrivanía con vertical file Sx CM.1108.ES e top Desk with left vertical file CM.1108.ES and top Bureau avec classeurs verticaux gauche CM.1108.ES et dessus Schreibtisch mit Vertical File links CM.1108.ES und Top Bureau met vertical file links CM.1108.ES en top Escritorio con archivadores verticales izquierdo CM.1108.ES y sobre	L. 80÷200 P. 80 H. 74	W. 31 1/2"÷78 3/4" D. 31 1/2" H. 29"
	Scrivanía a ponte su mobile di servizio scorrevole Bridge desk on service cabinet Bureau pont sur meuble de service Schreibtisch-Brücke auf Werkboxmodul Brugtafel op dienstmeubel Escritorio puente en mueble de servicio	L. 120÷180 P. 142 H. 74	W. 47 1/4"÷78 3/4" D. 56" H. 29"
	Scrivanía a ponte su mobile di servizio Eko BD.1206.C3 Bridge desk on service cabinet EKO BD.1206.C3 Bureau pont sur meuble de service EKO BD.1206.C3 Schreibtisch-Brücke auf Werkboxmodul EKO BD.1206.C3 Brugtafel op dienstmeubel EKO BD.1206.C3 Escritorio puente en mueble de servicio EKO BD.1206.C3	L. 120÷180 P. 142 H. 74	W. 47 1/4"÷78 3/4" D. 56" H. 29"
	Scrivanía + dattilo appeso Desk + workwall Bureau + dactylo suspendu Schreibtisch + Hängender Tischmodul Bureau + oplegtafel Escritorio + ala escritorio suspendida	L. 140÷180 P. 160÷200 H. 74	W. 55"÷70 3/4" D. 63"÷78 3/4" H. 29"

		cm	inch
	Scrivanía + dattilo appeso con cassettiera portante CM.0407.M4 Desk + workwall with drawer unit CM.0407.M4 Bureau + dactylo suspendu avec caisson portant CM.0407.M4 Schreibtisch + Hängender Tischmodul mit tragendem Schubladenelement CM.0407.M4 Bureau + oplegtafel met dragend ladenblok CM.0407.M4 Escritorio + ala escritorio suspendida con cajonera portante CM.0407.M4	L. 140÷180 P. 160÷200 H. 74	W. 55"÷70 3/4" D. 63"÷78 3/4" H. 29"
	Scrivanía 120° Desk 120° Bureau 120° Schreibtisch 120° Bureau 120° Escritorio 120°	L. 208 P. 126 H. 74	W. 81 3/4" D. 49 3/4" H. 29"
	Scrivanía 135° Desk 135° Bureau 135° Schreibtisch 135° Bureau 135° Escritorio 135°	L. 177 P. 113 H. 74	W. 69 3/4" D. 44 1/2" H. 29"
	Scrivanía Desk Bureau Schreibtisch Bureau Escritorio	L. 80÷200 P. 60÷80 H. 65÷85	W. 31 1/2"÷78 3/4" D. 23 3/4"÷31 1/2" H. 25 1/2"÷33 1/2"
	Scrivanía Desk Bureau Schreibtisch Bureau Escritorio	L. 160÷200 P. 80 H. 65÷85	W. 63"÷78 3/4" D. 31 1/2" H. 25 1/2"÷33 1/2"
	Scrivanía Desk Bureau Schreibtisch Bureau Escritorio	L. 180 P. 90 H. 65÷85	W. 70 3/4" D. 35 1/2" H. 25 1/2"÷33 1/2"
	Scrivanía + dattilo appeso Desk + workwall Bureau + dactylo suspendu Schreibtisch + Hängender Tischmodul Bureau + oplegtafel Escritorio + ala escritorio suspendida	L. 140÷180 P. 160÷200 H. 65÷85	W. 55"÷70 3/4" D. 63"÷78 3/4" H. 25 1/2"÷33 1/2"

Alcuni esempi di possibili configurazioni - Some examples of possible layouts - Voici quelques exemples de configurations possibles - Einige Beispiele von möglichen Konfigurationen - Een aantal voorbeelden van mogelijke configuraties - Algunos ejemplos de configuraciones posibles

Per una più completa visione della collezione, consultare il listino
Pour un meilleur aperçu de la collection, veuillez consulter la liste des prix
Om de volledige collectie te raadplegen, zie de lijst

To view the collection in more detail, please refer to our price list
Eine komplette Ansicht der Kollektion finden Sie in der Preisliste
Para ver más detalladamente la colección, consultar la tarifa

		cm	inch
	Scrivanía Desk Bureau Schreibtisch Bureau Escritorio	L. 80÷180 P. 60÷80 H. 65÷85	W. 31 1/2"÷70 3/4" D. 23 3/4"÷31 1/2" H. 25 1/2"÷33 1/2"
	Scrivanía Desk Bureau Schreibtisch Bureau Escritorio	L. 160÷180 P. 80 H. 65÷85	W. 63"÷70 3/4" D. 31 1/2" H. 25 1/2"÷33 1/2"
	Scrivanía Desk Bureau Schreibtisch Bureau Escritorio	L. 180 P. 90 H. 65÷85	W. 70 3/4" D. 35 1/2" H. 25 1/2"÷33 1/2"
	Scrivanía + dattilo appeso Desk + workwall Bureau + dactylo suspendu Schreibtisch + Hängender Tischmodul Bureau + oplettafel Escritorio + ala escritorio suspendida	L. 140÷180 P. 160÷200 H. 65÷85	W. 55"÷70 3/4" D. 63"÷78 3/4" H. 25 1/2"÷33 1/2"
	Scrivanía 120° Desk 120° Bureau 120° Schreibtisch 120° Bureau 120° Escritorio 120°	L. 208 P. 126 H. 65÷85	W. 81 3/4" D. 49 3/4" H. 25 1/2"÷33 1/2"
	Scrivanía 135° Desk 135° Bureau 135° Schreibtisch 135° Bureau 135° Escritorio 135°	L. 176,6 P. 113,2 H. 65÷85	W. 69 1/2" D. 44 1/2" H. 25 1/2"÷33 1/2"
	Scrivanía Desk Bureau Schreibtisch Bureau Escritorio	L. 140÷180 P. 80 H. 65÷85	W. 55"÷70 3/4" D. 31 1/2" H. 25 1/2"÷33 1/2"







		cm	inch
	Scrivanía Desk Bureau Schreibtisch Bureau Escritorio	L. 160÷180 P. 80 H. 65÷85	W. 63"÷70 3/4" D. 31 1/2" H. 25 1/2"÷33 1/2"
	Scrivanía Desk Bureau Schreibtisch Bureau Escritorio	L. 180 P. 90 H. 65÷85	W. 70 3/4" D. 35 1/2" H. 25 1/2"÷33 1/2"
	Scrivanía + dattilo appeso Desk + workwall Bureau + dactylo suspendu Schreibtisch + Hängender Tischmodul Bureau + oplettafel Escritorio + ala escritorio suspendida	L. 140÷180 P. 160÷200 H. 65÷85	W. 55"÷70 3/4" D. 63"÷78 3/4" H. 25 1/2"÷33 1/2"
	Scrivanía Desk Bureau Schreibtisch Bureau Escritorio	L. 140÷180 P. 80 H. 65÷130	W. 55"÷70 3/4" D. 31 1/2" H. 25 1/2"÷51"
	Scrivanía Desk Bureau Schreibtisch Bureau Escritorio	L. 140÷180 P. 80 H. 65÷130	W. 55"÷70 3/4" D. 31 1/2" H. 25 1/2"÷51"
	Scrivanía bench Desk bench Bureau bench Schreibtisch bench Bureau bench Escritorio bench	L. 140÷180 P. 164 H. 65÷85	W. 55"÷70 3/4" D. 64 1/2" H. 25 1/2"÷33 1/2"
	Scrivanía bench Desk bench Bureau bench Schreibtisch bench Bureau bench Escritorio bench	L. 140÷180 P. 164 H. 65÷85	W. 55"÷70 3/4" D. 64 1/2" H. 25 1/2"÷33 1/2"

Alcuni esempi di possibili configurazioni - Some examples of possible layouts - Voici quelques exemples de configurations possibles - Einige Beispiele von möglichen Konfigurationen - Een aantal voorbeelden van mogelijke configuraties - Algunos ejemplos de configuraciones posibles

Per una più completa visione della collezione, consultare il listino
Pour un meilleur aperçu de la collection, veuillez consulter la liste des prix
Om de volledige collectie te raadplegen, zie de lijst

To view the collection in more detail, please refer to our price list
Eine komplette Ansicht der Kollektion finden Sie in der Preisliste
Para ver más detalladamente la colección, consultar la tarifa

		cm	inch
	Scrivanía bench Desk bench Bureau bench Schreibtisch bench Bureau bench Escritorio bench	L. 140÷180 P. 164 H. 65÷85	W. 55"÷70 ¾" D. 64 ½" H. 25 ½"÷33 ½"
	Scrivanía bench Desk bench Bureau bench Schreibtisch bench Bureau bench Escritorio bench	L. 140÷180 P. 164 H. 65÷130	W. 55"÷70 ¾" D. 64 ½" H. 25 ½"÷51"
	Scrivanía bench Desk bench Bureau bench Schreibtisch bench Bureau bench Escritorio bench	L. 140÷180 P. 164 H. 65÷130	W. 55"÷70 ¾" D. 64 ½" H. 25 ½"÷51"
	Scrivanía bench Desk bench Bureau bench Schreibtisch bench Bureau bench Escritorio bench	L. 140÷180 P. 164 H. 65÷130	W. 55"÷70 ¾" D. 64 ½" H. 25 ½"÷51"
	Scrivanía bench Desk bench Bureau bench Schreibtisch bench Bureau bench Escritorio bench	L. 140÷180 P. 164 H. 65÷130	W. 55"÷70 ¾" D. 64 ½" H. 25 ½"÷51"
	Tavolino Small table Petit table Kleinertisch Kleine tafel Mesa	L. 70 P. 70 H. 40	L. 27 ½" D. 27 ½" H. 17 ¼"
	Tavolino Small table Petit table Kleinertisch Kleine tafel Mesa	L. 70÷80 P. 70÷80 H. 74	L. 27 ½"÷31 ½" D. 27 ½"÷31 ½" H. 29"



		cm	inch
	Tavolino Small table Petit table Kleinertisch Kleine tafel Mesa	L. 70 P. 70 H. 105	L. 27 ½" D. 27 ½" H. 41 ¼"
	Tavolo Table Table Tisch Tafel Mesa	L. 140÷160 P. 140÷160 H. 74	L. 55"÷63" D. 55"÷63" H. 29"
	Tavolo Table Table Tisch Tafel Mesa	L. 180 ÷ 240 P. 100 H. 74	L. 70 ¾"÷94 ½" D. 39 ¼" H. 29"
	Tavolo sagomato con colonna e base Shaped table with column and base Table façonnée avec colonne et base Tisch geformt mit Säule und Basis Gevormde tafel met kolom en basis Mesa per'lada con columna y base	L. 200 P. 104 H. 74	L. 78 ¾" D. 41" H. 29"
	Tavolo sagomato Shaped table Table façonnée Tisch geformt Gevormde tafel Mesa per'lada	L. 240 P. 120 H. 74	L. 94 ½" D. 47 ¼" H. 29"
	Tavolo Table Table Tisch Tafel Mesa	L. 204 ÷ 324 P. 124 L. 244 ÷ 364 P. 164 H. 74	W. 80 ¼" ÷ 127 ½" D. 48 ¾" W. 96" ÷ 143 ¼" D. 64 ½" H. 29"
	Tavolo Table Table Tisch Tafel Mesa	L. 360÷480 P. 100 H. 74	L. 141 ¾"÷189" D. 39 ¼" H. 29"

Alcuni esempi di possibili configurazioni - Some examples of possible layouts - Voici quelques exemples de configurations possibles - Einige Beispiele von möglichen Konfigurationen - Een aantal voorbeelden van mogelijke configuraties - Algunos ejemplos de configuraciones posibles

Per una più completa visione della collezione, consultare il listino
 Pour un meilleur aperçu de la collection, veuillez consulter la liste des prix
 Om de volledige collectie te raadplegen, zie de lijst

To view the collection in more detail, please refer to our price list
 Eine komplette Ansicht der Kollektion finden Sie in der Preisliste
 Para ver más detalladamente la colección, consultar la tarifa

winglet[™]
technical

		cm	inch
	Tavolo sagomato Shaped table Table façonnée Tisch geformt Gevormde tafel Mesa per'lada	L. 220 P. 120 H. 74	L. 86 3/4" D. 47 1/4" H. 29"
	Tavolo sagomato Shaped table Table façonnée Tisch geformt Gevormde tafel Mesa per'lada	L. 450 P. 450 H. 74	L. 177" D. 177" H. 29"
	Scrivania su ruote Desk Bureau Schreibtisch Bureau Escritorio	L. 120÷180 P. 80 H. 74	W. 47 1/4" ÷ 70 3/4" D. 31 1/2" H. 29"

Tipologie schermi - Types of screens - Types d'écrans - Schirm-Typen - Schermtypen - Tipos de pantallas

Per una più completa visione della collezione, consultare il listino
 Pour un meilleur aperçu de la collection, veuillez consulter la liste des prix
 Om de volledige collectie te raadplegen, zie de lijst

To view the collection in more detail, please refer to our price list
 Eine komplette Ansicht der Kollektion finden Sie in der Preisliste
 Para ver más detalladamente la colección, consultar la tarifa

Schermi divisori - Screens dividers - Écrans de séparation frontale - Trennschirme - Schermverdeling - Pantallas separadoras



Schermo frontale tessuto sp. 18 mm / 0¾"

Front fabric screen:
18 mm / 0¾" thick
Écran frontal en tissu
ép. 18 mm / 0¾"
Frontaler Schirm stoffbezogen
Stärke 18 mm / 0¾"
Schermscherm voorkant in stof dikte
18 mm / 0¾"
Pantalla frontal de tejido esp.
18 mm / 0¾"



Schermo frontale alto melaminico sp. 18 mm, 0¾"

Front high laminate screen:
18 mm / 0¾" thick
Écran frontal haut mélaminé
ép. 18 mm / 0¾"
Frontaler hoher Schirm Melamin
Stärke 18 mm / 0¾"
Hoog scherm voorkant
melamine dikte 18 mm / 0¾"
Pantalla frontal alta melamina
esp. 18 mm / 0¾"



Schermo divisorio in tessuto fonoassorbente sp 42 mm / 1¾" con profilo

Sound-absorbing fabric screen:
42 mm / 1¾" thick with profile
Écran de séparation frontale en tissu insonorisant
ép. 42 mm / 1¾" avec profil
Trennschirm aus schallschluckendem Stoff Stärke
42 mm / 1¾" mit Profil
Schermschermverdeling in akoestische stof dikte 42 mm
/ 1¾" met profiel
Pantalla separadora de tejido fonoabsorbente
esp. 42 mm / 1¾" con perfil

Schermi divisori laterali - Side screens dividers - Écrans de séparation latérale - Seitliche Trennschirme - Schermverdeling zijkant - Pantallas separadoras laterales



Schermo divisorio laterale laccato sp 18 mm / 0¾"

Lacquered side screen:
18 mm / 0¾" thick
Écran de séparation latérale laqué
ép. 18 mm / 0¾"
Seitlicher Trennschirm lackiert
Stärke 18 mm / 0¾"
Gelakte schermverdeling zijkant
dikte 18 mm / 0¾"
Pantalla separadora lateral lacada
esp. 18 mm / 0¾"



Schermo riposizionabile in tessuto fonoassorbente sp 42 mm / 1¾"

Sound-absorbing mobile fabric side
screen 42 mm / 1¾" thick
Écran de séparation latérale en tissu
ép. 42 mm / 1¾"
Beliebig montierbarer Schirm aus
schallschluckendem Stoff Tiefe 42 mm
/ 1¾"
Stoffen schermverdeling zijkant
dikte 42 mm / 1¾"
Pantalla separadora lateral de tejido
fonoabsorbente
esp. 42 mm / 1¾"

Sistemi per il passaggio cavi e per l'elettificazione dei piani - Cable holding and top electrification systems - Systèmes passe-câbles et pour l'électrification des plateaux - Systeme für Kabeldurchlass und Elektrifizierung der Tischplatten - Kabeldoorvoersystemen en bekabelingssystemen van de bladen - Sistemas para el paso de los cables y para la electrificación de los sobres



uscita cavi sul piano tramite top access e tappi passacavi
top cable outlet through top access and cable holder port / sortie des câbles sur le plateau par top-access ou passe-câbles avec obturateur / Kabelaustritt auf der Tischplatte über Top Access und Kabel Dosen / kabeluitgang op het blad via top access en kabeldoorvoerdoppen / salida de los cables en el sobre mediante acceso superior y tapones pasacables



salita cavi attraverso passacavi attaccato alla gamba
cable holder fastened to the leg / remontée des câbles par le passe-câbles fixé au piètement / Kabelhochführung durch am Tischbein befestigte Kabeldurchführungen / mogelijkheid om kabels omhoog te voeren via kabeldoorvoer die vastgemaakt is aan de poot / salida de los cables a través de pasacables acoplado a la pata



con un semplice movimento, il piano arretra per consentire un facile accesso ai cavi
with a simple movement, the top moves backward for easy access to the cables / avec un simple mouvement, le plateau recule pour permettre un accès aisé aux câbles / mit einer einfachen Bewegung, die Tischplatte fährt zurück, um einen leichten Zugang zu den Kabeln zu ermöglichen / met een eenvoudige beweging wordt het blad teruggeschoven, waardoor de kabels op eenvoudige wijze toegankelijk zijn / con un simple movimiento, el sobre retrocede para facilitar el acceso de los cables

Per una più completa visione della collezione, consultare il listino
Pour un meilleur aperçu de la collection, veuillez consulter la liste des prix
Om de volledige collectie te raadplegen, zie de lijst

To view the collection in more detail, Please refer to our price list
Eine komplette Ansicht der Kollektion finden Sie in der Preisliste
Para ver más detalladamente la colección, consultar la tarifa



L'ampio alloggiamento nella vasca passacavi permette di mantenere ordinati e facilmente ispezionabili tutti i cavi e le connessioni

The wide cable holder tray housing allows you to keep all cables and connections neat and inspect them. / le grand logement dans le bac passe-câbles permet de maintenir les câbles et les branchements en ordre et facilement accessibles / Dank der großen Aufnahme in der Kabelrinne können alle Kabel und Anschlüsse in Ordnung gehalten und einfach kontrolliert werden / dankzij de ruime kabelgoot kunnen alle kabels en verbindingen ordelijk bewaard worden en kunnen ze eenvoudig geïnspecteerd worden / el amplio alojamiento de la bandeja pasacables permite mantener en orden todos los cables y las conexiones, facilitando su inspección

salita cavi tramite vertebra
vertebra cable holder / vertebre montée de câbles / Kabelhochführung durch Spirale / kabels via verticale geleider / ascenso de los cables mediante vértebra*

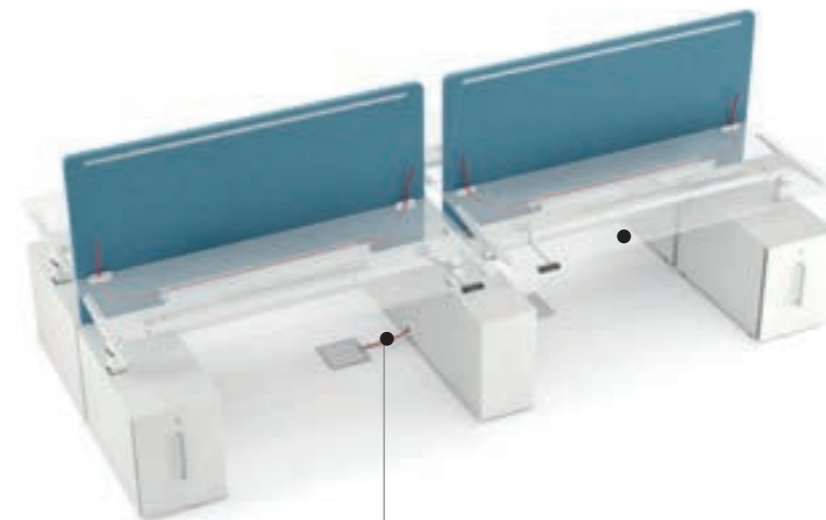

salita cavi attraverso il muretto centrale facilmente ispezionabili per il posizionamento dei cavi

cable holder through central wall easy to inspect when placing the cables / remontée des câbles par le piètement plein central facilement accessible pour le positionnement des câbles / Kabelhochführung über die Mittelwange, zwecks einfach zu kontrollierender Positionierung der Kabel / gemakkelijk inspecteerbare kabelopgang via de centrale wand voor het plaatsen van de kabels / salida de los cables a través del tabique central fácilmente inspeccionable para la colocación de los cables

Flipper, struttura e sistema di elettrificazione - Flipper, structure and electrification system
- Flipper, structure et système d'électrification - Flipper, Struktur und Elektrifizierungssystem -
Flipper, structuur en bekabelingssysteem - Flipper, estructura y sistema de electrificación

i cavi elettrici e i dati entrano dal basso o da appositi passaggi laterali e sono resi disponibili in diverse posizioni per alimentare il TV sul pannello frontale, oppure un tablet sulla mensola dedicata o ancora una web cam collocabile sulla parte superiore

Electric and data cables enter from the bottom or through special side holes, and are available in different positions to supply the TV on the front panel, or a tablet on the special shelf, or a webcam which can be placed on the upper section / Les câbles électriques et de données entrent par le bas ou par des passages latéraux spéciaux et ils sont mis à disposition dans des positions différentes pour alimenter le téléviseur sur le panneau avant, ou une tablette sur la console dédiée ou même une webcam pouvant être placée sur la partie supérieure / Elektrische Kabel oder Datenleitungen kommen von unten oder durch seitliche Öffnungen und sind in mehreren Positionen nutzbar zur Versorgung eines Fernsehers auf der Frontblende, eines Tablets auf der entsprechenden Konsole oder einer Webcam, die auf der oberen Seite positioniert werden kann / De voedings- en datakabels komen vanuit onderaf naar binnen of door de speciaal hiervoor bestemde openingen aan de zijkant en worden beschikbaar gemaakt in verschillende posities om de televisie op het voorpaneel te voeden, of een tablet op de hiervoor bestemde plank of een webcam die op het bovengedeelte geplaatst kan worden / Los cables eléctricos y de datos entran por abajo o por unos orificios laterales y resultan disponibles en distintas posiciones para alimentar la TV en el panel frontal, una tableta en el estante correspondiente o una cámara web colocada en la parte superior

il pannello svolge anche la funzione di lavagna scrivibile

The panel is also a whiteboard / Le panneau sert également de tableau blanc / Die Blende hat auch die Funktion einer beschriftbaren Tafel / Het paneel doet ook dienst als whiteboard / El panel desempeña también la función de pizarra escribible

i pannelli sono facilmente riposizionabili per un agevole posizionamento, controllo o manutenzione dei cavi all'interno

All panels can be easily detached to place, check or service the cables inside / Les panneaux peuvent être facilement repositionnés pour faciliter le positionnement, le contrôle ou l'entretien des câbles à l'intérieur / Die Blenden sind mühelos abnehmbar für eine einfache Inspektion und Wartung der Kabel im Inneren / De panelen kunnen makkelijk van positie worden verplaatst en worden herplaatst voor controle en onderhoud van de kabels of onderhoud van de interne kabels / Los paneles pueden desplazarse cómodamente para facilitar la colocación, el control o el mantenimiento de los cables presentes en el interior

ruote di ampie dimensioni per una agevole traslazione, dotate di blocco

Wide wheels with locking brake for higher ease of movement / Grandes roues pour un déplacement aisé, équipées de frein / Große Laufrollen für eine einfache Bewegung, ausgestattet mit Arretierung / Grote wielen voor een vlotte verplaatsing, met rem / Ruedas de amplias dimensiones para facilitar el desplazamiento, dotadas de bloqueo

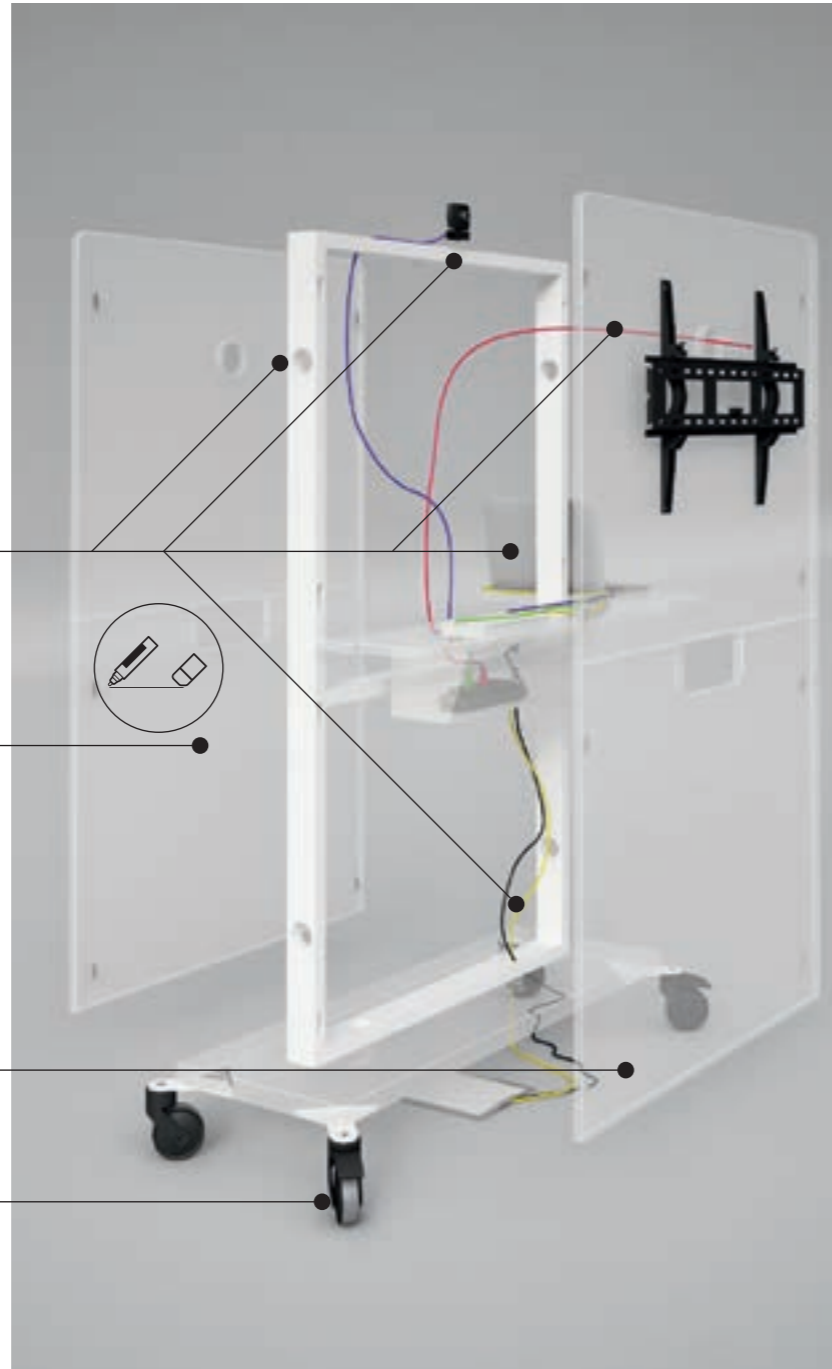

Per una più completa visione della collezione, consultare il listino
 Pour un meilleur aperçu de la collection, veuillez consulter la liste des prix
 Om de volledige collectie te raadplegen, zie de lijst

To view the collection in more detail, Please refer to our price list
 Eine komplette Ansicht der Kollektion finden Sie in der Preisliste
 Para ver más detalladamente la colección, consultar la tarifa

i cavi di alimentazione e dati possono entrare dagli appositi passaggi Flipper, alimentare i vari devices presenti ed essere resi disponibili anche per il piano meeting

Electric and data cables enter from the special holes on Flipper holes, to supply the different devices, and can be extended also to the meeting table / Les câbles d'alimentation et de données peuvent entrer par des passages spéciaux du Flipper, alimenter les divers appareils électriques présents et sortir éventuellement sur le plateau de la table de réunion / Elektrische Kabel und Datenleitungen für Geräte können durch die Flipper-Öffnungen eingeführt werden, und auch auf der Besprechungstischplatte verfügbar sein / De voedings- en gegevenskabels kunnen door de speciaal hiervoor bedoelde geleidingen van Flipper gestoken worden, de verschillende aanwezige toestellen voeden en ook beschikbaar zijn op het vergaderblad / Los cables de alimentación y de datos pueden entrar por los orificios correspondientes de Flipper, alimentar los distintos dispositivos y resultar también disponibles para el sobre de la mesa de reuniones



Flipper, nella versione a muro, è dotato di piedini di sostegno e regolazione

The wall version of Flipper is equipped with support and adjustment feet / Flipper, dans sa version murale, est équipé de pieds de support réglables / Flipper in der Wandausführung ist mit Stütz- und Justierfüßchen ausgestattet / De muurversie van Flipper beschikt over ondersteunende en afstelbare poten / En la versión de pared, Flipper está dotado de patas de soporte y regulación

Sistema Ubi - Ubi system - Système Ubi - Ubi System - System Ubi - Sistema Ubi

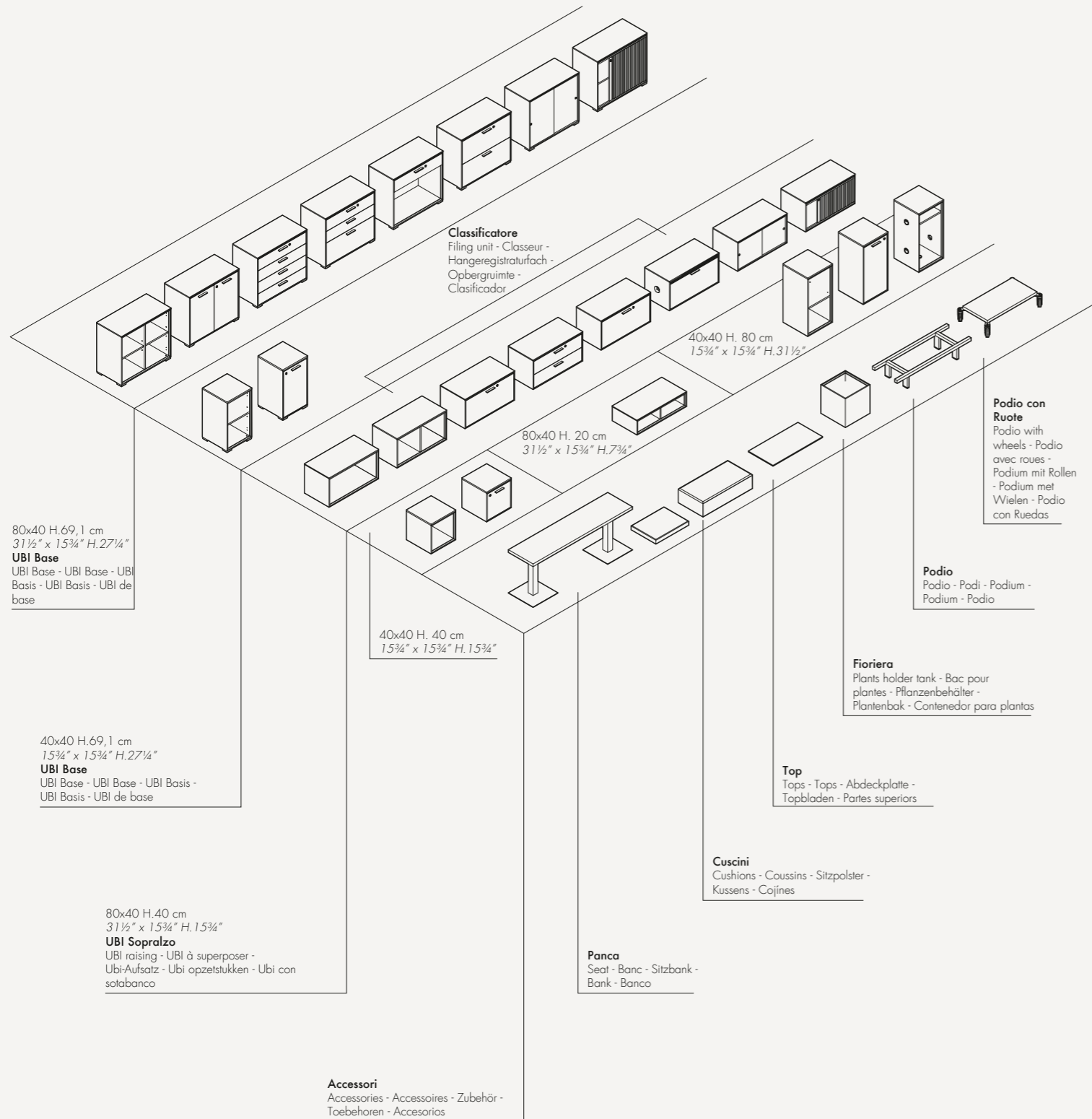

Cassettiere e mobili di servizio - Drawers and service cabinets - Caissons et meubles de service - Container und Sideboards - Ladekasten en service-unit - Cajoneras y muebles de servicio

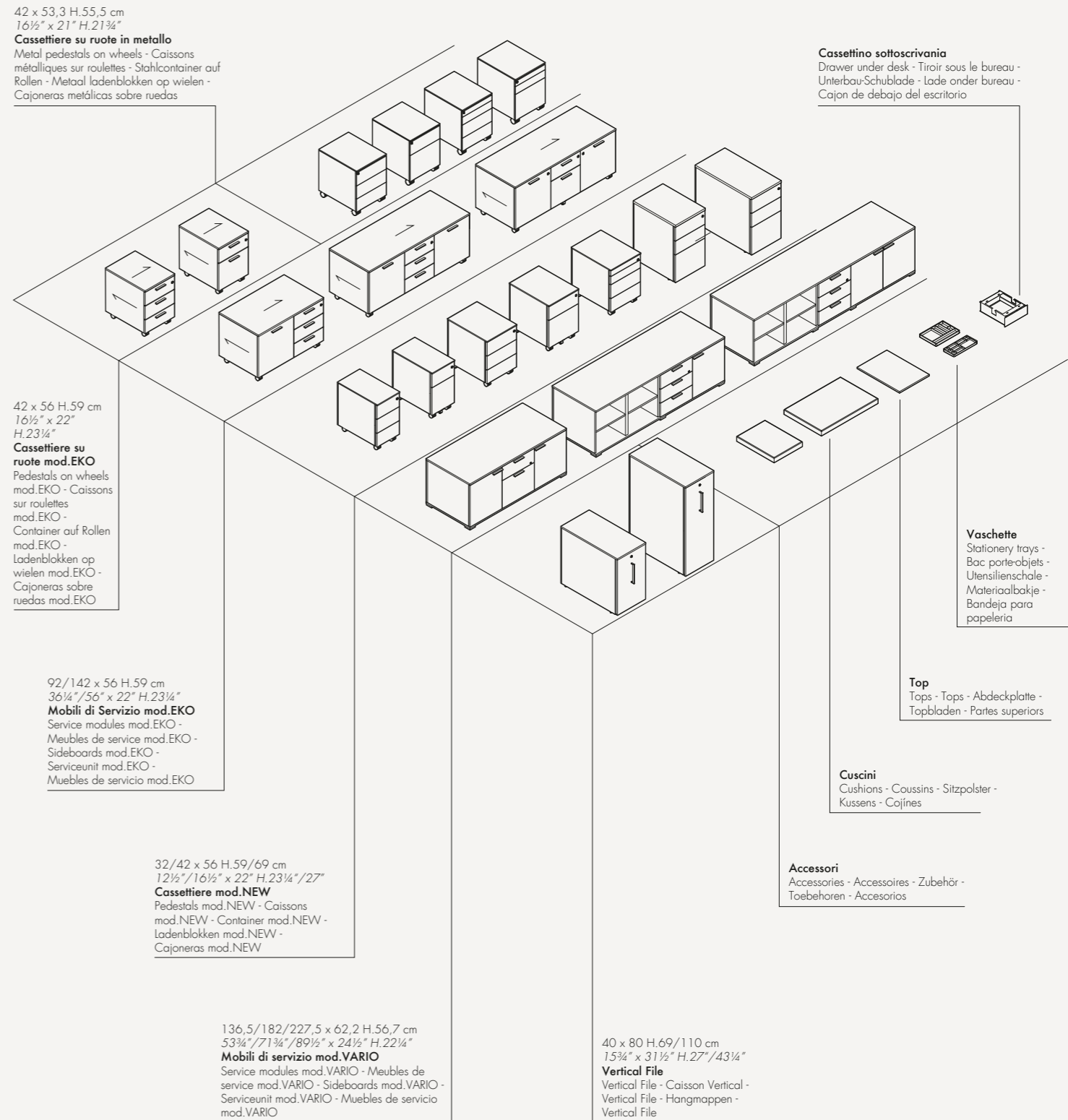

Armadi A100 p.36 cm / 14" - A100 closet system - d. 36 / 14" - Armoires A100 - p. 36/14" - Schranksystem A100 - Tiefe 36/14" - Systeem Kasten A100 - d. 36/14" - Armarios A100 - p. 36 cm/14"

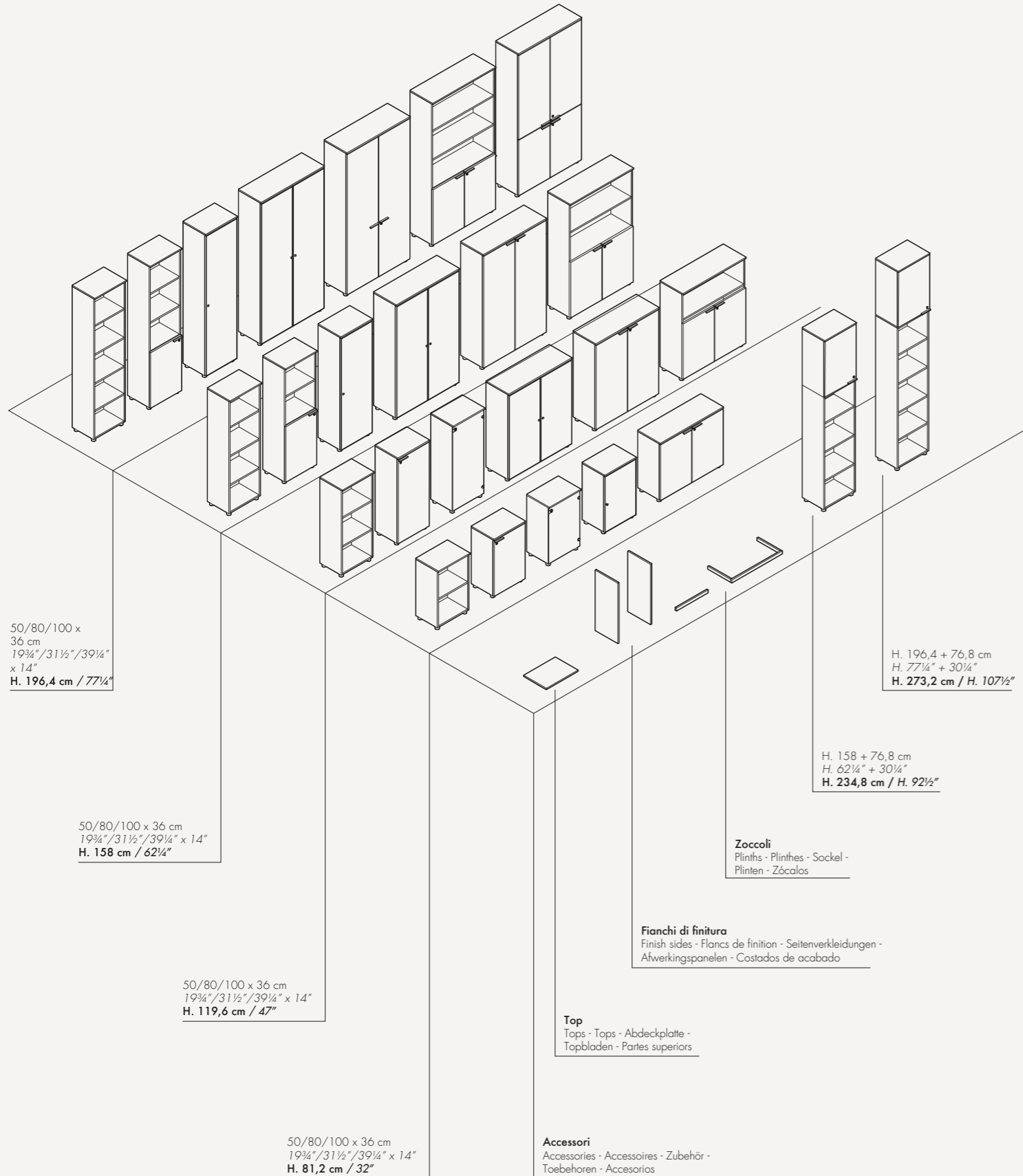

Armadi A100 p.46 cm / 18" - A100 closet system - d. 46 / 18" - Armoires A100 - p. 46/18" - Schranksystem A100 - Tiefe 46/18" - Systeem Kasten A100 - d. 46/18" - Armarios A100 - p. 46 cm/18"

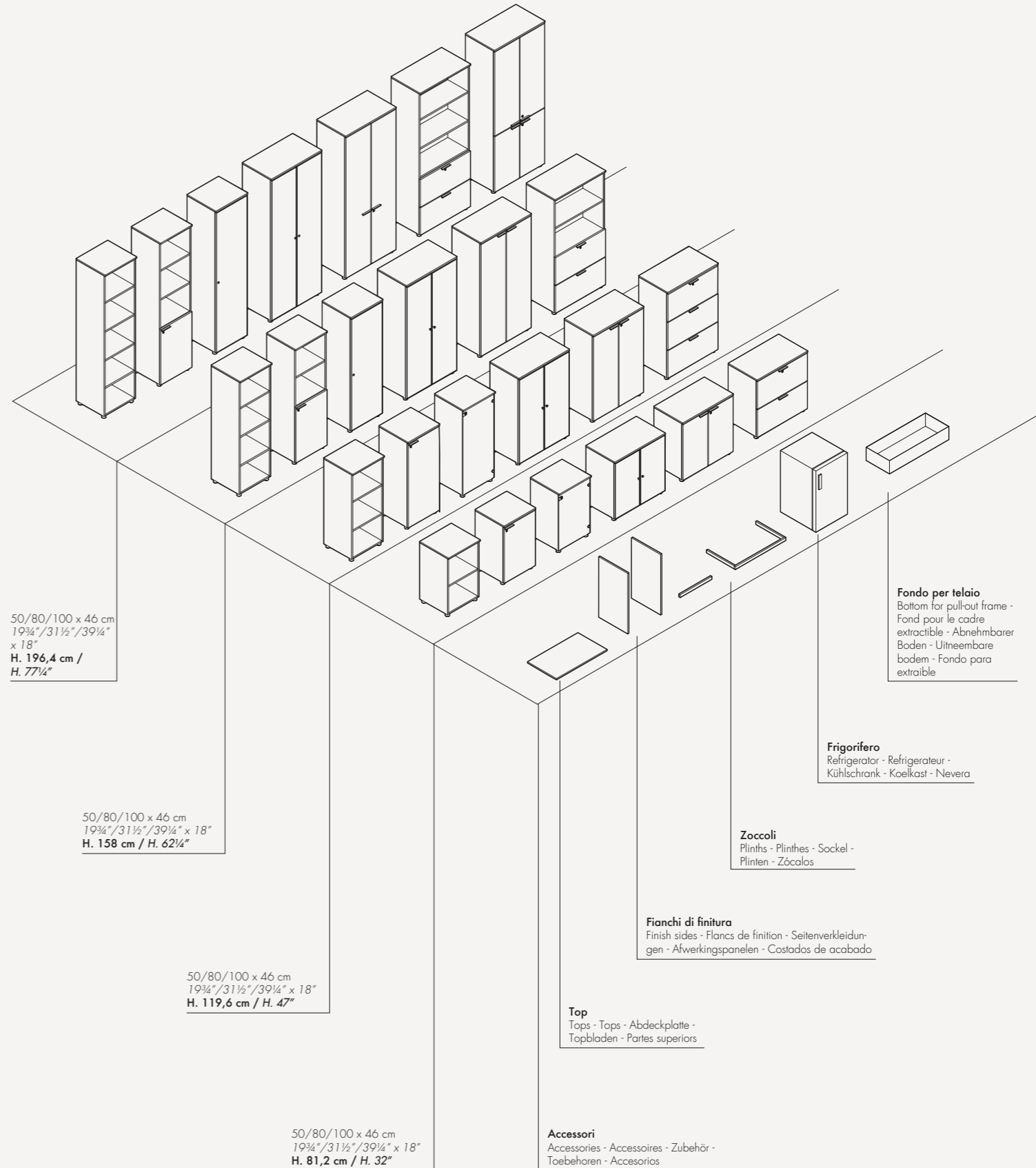

Accessori - Accessories - Accessoires - Zubehör - Accessoires - Accesorios

Per una più completa visione della collezione, consultare il listino
 Pour un meilleur aperçu de la collection, veuillez consulter la liste des prix
 Om de volledige collectie te raadplegen, zie de lijst

To view the collection in more detail, Please refer to our price list
 Eine komplette Ansicht der Kollektion finden Sie in der Preisliste
 Para ver más detalladamente la colección, consultar la tarifa

Tappo passacavi - Cable access port - Passe-câbles - Kabeldose - Kabeldoorvoerdp - Tapón pasacables



GZ.0008.B0



GZ.0008.A0

Top access - Top access - Top-access - Top access - Toegang bovenaan - Acceso superior



GZ.0058.A2



GZ.0024./A3 + GZ.0012.EU/.FR/.UK



GZ.0062.A3

Portaprese - Socket-holder - Porte-prises - Elektro-Dosenblock - Stekker - Portatomas de corriente



GZ.0057.AE/.AF/.AU



GZ.0066.A1



GZ.0047.EU/.FR/.UK



GZ.0019.A0/.AF

Cestelli portacavi - Cable holder baskets - Bac passe-cables - Kabelkörbe - Korfjes voor elektrische bedrading - Cestos portacables



GZ.0043.P1 - GZ.0046.P1



GZ.0067.P1



GZ.0068.P1

Passacavi - Cable holder - Passe-câbles - Kabeldurchführungen - Kabeldoorvoer - Pasacables



GZ.0072.00



BZ.0072.00



GZ.0070.01



GZ.0059.01 / ZZ.0003.01

Braccio portamonitor - Monitor stand - Porte-écran - Monitorträger - Monitorsteun - Brazo para monitor



GZ.0081.M1



GZ.0060.01 GZ.0060.02

Accessori - Accessories - Accessoires - Zubehör - Accessoires - Accesorios

Per una più completa visione della collezione, consultare il listino
Pour un meilleur aperçu de la collection, veuillez consulter la liste des prix
Om de volledige collectie te raadplegen, zie de lijst

To view the collection in more detail, Please refer to our price list
Eine komplette Ansicht der Kollektion finden Sie in der Preisliste
Para ver más detalladamente la colección, consultar la tarifa

Porta cpu - CPU holder - Support pour unité centrale - CPU Halter - CPU-houder - Soporte para CPU



WZ.0009.G1

Cassettino sottocrivania - Under-desk drawer - Tiroir sous le bureau - Unterbau-Schublade - Lade onder bureau - Cajón de debajo del escritorio



TZ.0304.00

Staffe di giunzione / aggregazione piani - Joining brackets / Top coupling - Étriers de jonction / assemblage plateaux - Plattenverbindungs-/anschlusssträger - Bevestigingsbeugels / haken voor bladen - Estribos de unión / agregación sobres



Sistemi di regolazione - Adjustment systems - Systèmes de réglage - Einstellsysteme - Instellingssystemen - Sistemas de regulación



Pulsante
Push button - Bouton-pous-soir - Schalter - Drukknop - Pulsador



Manovella
Crank - Manivelle - Kurbel - Slinger - Manivela



Tastierino Up&Down
Up&Down keypad - Bouton Up&Down - Druckknopf Up&Down - Up&Down bediening - Teclado Up&Down



Tastierino con 4 memorie e display
Keypad with 4 memories and display - Clavier avec 4 mémoires et afficheur lcd - Eingabefeld mit 4X Memory + Display - Bediening met display en 4 geheugenstanden - Teclado con 4 memorías y display

Compositions elements & dimensions

Per una più completa visione della collezione, consultare il listino
Pour une vue plus complète de la collection, voir la liste des prix
Voor een compleet overzicht van de collectie, zie de prijslijst
precios

For a more complete view of the collection, see the price list
Für eine vollständigere Ansicht der Sammlung finden Sie in der Preisliste
Para una visión más completa de la colección, consulte la lista de

22/23 24/25 26/27

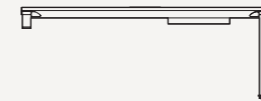

200 x 80 H.74 cm 78¾" x 31½" H.29"
Scrivania
Desk - Bureau - Schreibtisch - Bureau - Escritorio



141,8 x 56,3 H.57 cm 55¾" x 22" H.22½"
Mobile di servizio mod. Eko
Service Cabinet EKO - Meuble de service - Sideboard EKO - Serviceunit EKO - Mueble de servicio EKO



364 x 164 H.74 cm 143¼" x 64½" H.29"
Tavolo riunione
Meeting table - Table de réunion - Konferenztisch - Vergadertafel - Mesa de reunión



60 x 60 H.40 cm 23¾" x 23¾" H.15¾"
Tavolino
Small table - Petit table - Kaffeetisch Kleine tafel - Mesa

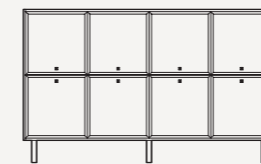

203,6 x 46 H.123 cm 80" x 18" H.48½"
Credenza 4+4 ante
Cabinet 4+4 doors - Armoire basse 4+4 portes - Anrichte 4+4 Türen - Kast 4+4 deuren - Aparador 4+4 puertas

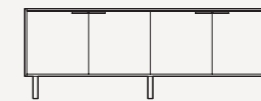

203,6 x 46 H.71,8 cm 80" x 18" H.28¼"
Credenza 2+2 ante
Cabinet 2+2 doors - Armoire basse 2+2 portes - Anrichte 2+2 Türen - Kast 2+2 deuren - Aparador 2+2 puertas

28/29 30/31



180 x 90 H.74 cm 70¾" x 35½" H.29"
Scrivania
Desk - Bureau - Schreibtisch - Bureau - Escritorio



120 x 60 H.74 cm 47¼" x 23¾" H.29"
Dattilo appeso
Workwall - Dactylo suspendu - Andocktisch - Oplegtafel - Ala escritorio suspendida



41,8 x 56,3 H.58,7 cm 16½" x 22" H.23"
Cassettiera 2 cassetti
Pedestal 2 drawers - Caisson 2 tiroirs - 2 Schubladen Container - Ladenblok 2 laden - Cajonera 2 cajones



200 x 104 H.74 cm 78¾" x 41" H.29"
Tavolo riunione
Meeting table - Table de réunion - Konferenztisch - Vergadertafel - Mesa de reunión



303,6 x 46 H.159,8 cm 119½" x 18" H.63"
Armadio mod. A100
A100 Cabinet - Armoire A100 - Schränke A100 - Kasten A100 - Armario A100



Ø140 H.74 cm Ø55" H.29"
Tavolo riunione
Meeting table - Table de réunion - Konferenztisch - Vergadertafel - Mesa de reunión

Compositions elements & dimensions

32/33 34/35



180 x 80 H.65÷85 cm 70¾" x 31½" H.25½"÷33½"
Scrivania
Desk - Bureau - Schreibtisch - Bureau - Escritorio



120 x 60 H.65÷85 cm 47¼" x 23¾" H.25½"÷33½"
Dattilo appeso
Workwall - Dactylo suspendu - Andocktisch - Oplegtafel - Ala escritorio suspendida



41,8 x 56,3 H.58,7 cm 16½" x 22" H.23"
Cassettiera 2 cassetti
Pedestal 2 drawers - Caisson 2 tiroirs - 2 Schubladen Container - Ladenblok 2 laden - Cajonera 2 cajones



240 x 120 H.74 cm 94½" x 47¼" H.29"
Tavolo riunione
Meeting table - Table de réunion - Konferenztisch - Vergadertafel - Mesa de reunión

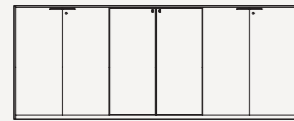

303,6 x 46 H.121,4 cm 119½" x 18" H.47¾"
Armadio mod. A100
A100 Cabinet - Armoire A100 - Schränke A100 - Kasten A100 - Armario A100

36/37 38/39

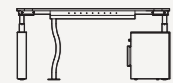

180 x 160 H.65÷130 cm 78¾" x 63" H.25½"÷51"
Scrivania con mobile
Desktop with cabinet - Bureau avec meuble - Schreibtisch mit Sideboard - Schrijftafel met meubel - Escritorio con mueble

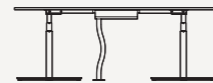

240 x 100 H.65÷130 cm 94½" x 39¼" H.25½"÷51"
Tavolo riunione
Meeting table - Table de réunion - Konferenztisch - Vergadertafel - Mesa de reunión

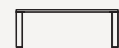

120 x 60 H.40 cm 47¼" x 23¾" H.15¾"
Tavolino
Small table - Petit table - Kaffeetisch - Kleine tafel - Mesa



70 x 70 H.40 cm 27½" x 27½" H.15¾"
Tavolino
Small table - Petit table - Kaffeetisch - Kleine tafel - Mesa

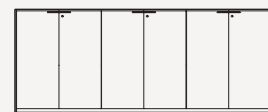

303,6 x 46 H.121,4 cm 119½" x 18" H.47¾"
Armadio mod. A100
A100 Cabinet - Armoire A100 - Schränke A100 - Kasten A100 - Armario A100



503,6 x 46 H.83 cm 198¼" x 18" H.32¾"
Armadio mod. A100
A100 Cabinet - Armoire A100 - Schränke A100 - Kasten A100 - Armario A100

42/43 44/45

Per una più completa visione della collezione, consultare il listino
Pour une vue plus complète de la collection, voir la liste des prix
Voor een compleet overzicht van de collectie, zie de prijslijst
precios

For a more complete view of the collection, see the price list
Für eine vollständigere Ansicht der Sammlung finden Sie in der Preisliste
Para una visión más completa de la colección, consulte la lista de

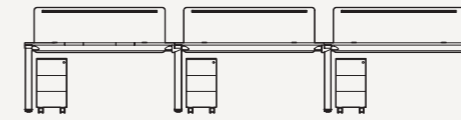

480 x 164 H.74 cm 189 x 64½" H.29"
Composizione Bench 6 p.
Bench composition 6 p. - Poste de travail 6 p. - Bench-Arbeitsplatz 6 p. - Samenstelling bench 6 p. - Composición bench 6 p.

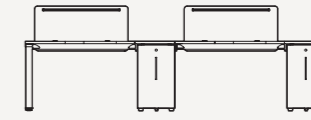

320 x 164 H.74 cm 126 x 64½" H.29"
Composizione Bench 4 p.
Bench composition 4 p. - Poste de travail 4 p. - Bench-Arbeitsplatz 4 p. - Samenstelling bench 4 p. - Composición bench 4 p.

140 x 2,1 x H.48 cm 55" x 0¾" H.18¾"
Schermo divisorio
High screen - Écran haut - Hoher Sichtschutz - Hoog scherm - Pantalla alta

100 x 2,1 x H.48 cm 39¼" x 0¾" H.18¾"
Schermo divisorio
High screen - Écran haut - Hoher Sichtschutz - Hoog scherm - Pantalla alta

31,8 x 56,3 H.58,7 cm 12½" x 22" H.23"
Cassettiera Slim 3 cassetti
Pedestal Slim 3 drawers - Caisson Slim 3 tiroirs - 3 Schubladen Slim Container - Ladenblok Slim 3 laden - Cajonera Slim 3 cajones

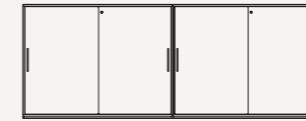

320 x 40 H.121,4 cm 126" x 15¾" H.47¾"
Armadio con ante scorrevoli
Cabinet with sliding doors - Armoire avec vantaux coulissants - Schränke mit Schiebetüren - Kasten met schuifdeuren - Armario con puertas correderas

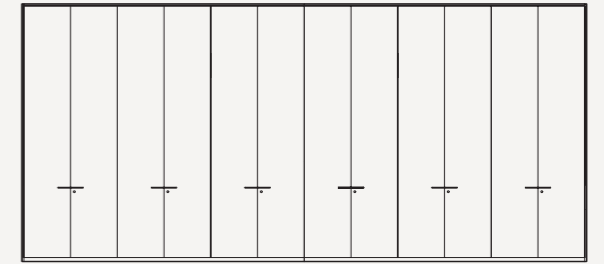

603,6 x 46 H.275 cm 237¾" x 18" H.108¼"
Armadio mod. A100
A100 Cabinet - Armoire A100 - Schränke A100 - Kasten A100 - Armario A100

46/47

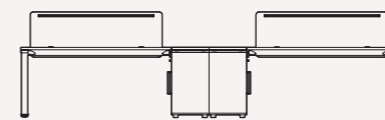

400 x 324 H.74 cm 157½" x 127½" H.29"
Composizione Bench
Bench composition - Poste de travail - Bench-Arbeitsplatz - Samenstelling bench - Composición bench

140 x 2,1 x H.48 cm 55" x 0¾" H.18¾"
Schermo divisorio
High screen - Écran haut - Hoher Sichtschutz - Hoog scherm - Pantalla alta

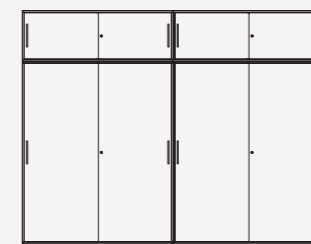

320 x 40 H.74 cm 126" x 15¾" H.29"
Armadio con ante scorrevoli
Cabinet with sliding doors - Armoire avec vantaux coulissants - Schränke mit Schiebetüren - Kasten met schuifdeuren - Armario con puertas correderas

320 x 40 H.249,5 cm 126" x 15¾" H.98¼"
Armadio con ante scorrevoli
Cabinet with sliding doors - Armoire avec vantaux coulissants - Schränke mit Schiebetüren - Kasten met schuifdeuren - Armario con puertas correderas

Compositions elements & dimensions

48/49

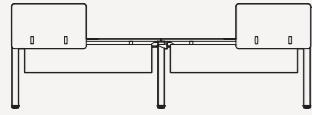

320 x 80 H.74 cm 126" x 31½" H.29"

N.02 Scrivanie
N.02 Desks - N.02 Bureaux - N.02 Schreibtische -
N.02 Bureaus - N.02 Escritorios

80 x 1,8 H.48 cm 31½" x 0¾" H.18¾"

Schermo
Screen - Écran - Sichtschutz - scherm - Pantalla

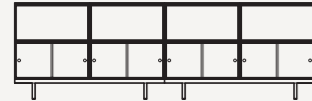

320,6 x 40 H.103 cm 126¼" x 15¾" H.40½"

Contentori mod. UBI EVO
UBI EVO Containers - Cubes UBI EVO - Container UBI EVO - Containers UBI
EVO - Contenedores UBI EVO



80 x 60 H.74 cm 31½" x 23¾" H.29"

Dattilo appeso
Warkwall - Dactylo suspendu - Andocktisch -
Oplegtafel - Ala escritorio suspendida



Ø60 H.40 cm Ø23¾" H.15¾"

Tavolino
Small table - Petit table - Kaffeetisch
Kleine tafel - Mesa

54/55

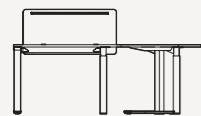

200,8 x 230,3 H.74 cm 78¾" x 90½" H.29"

N.02 Scrivanie
N.02 Desks - N.02 Bureaux - N.02 Schreibtische -
N.02 Bureaus - N.02 Escritorios

100 x 1,8 H.48 cm 39¾" x 0¾" H.18¾"

Schermo divisorio
High screen - Écran haut - Hoher Sichtschutz - Hoog scherm - Pantalla alta



142 x 56 H.57 cm 56" x 22" H.22½"

Mobile di servizio mod. Eko
Service Cabinet EKO - Meuble de service - Sideboard EKO -
Serviceunit EKO - Mueble de servicio EKO



320 x 40 H.74 cm 126" x 15¾" H.29"

Armadio
Cabinet - Armoire - Schränke - Kasten - Armario

56/57 58/59

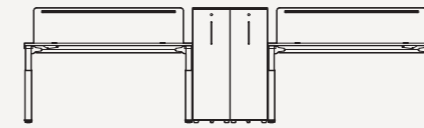

180 x 164 H.112,3 cm 70¾" x 64½" H.44¼"

Composizione Bench
Bench composition - Poste de travail - Bench-Arbeitsplatz - Samen-
stelling bench - Composición bench

40 x 80 H.112,2 cm 15¾" x 31½" H.44"

Vertical file (2dx+2sx)
Vertical file 2Rh+2Lh - Classeur vertical 2Dr+2Ga - Vertical File 2Re+2Li - Opbergunit
2Re+2Li - Archivador vertical 2De+2Li

179,5 x 4 H.58 cm 70¾" x 1½" H.22¾"

Schermo divisorio
High screen - Écran haut - Hoher Sichtschutz - Hoog scherm - Pantalla alta

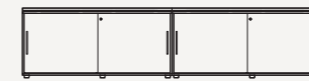

320 x 40 H.74 cm 126" x 15¾" H.29"

Armadio con ante scorrevoli
Cabinet with sliding doors - Armoire avec vantaux coulissants - Schränke mit
Schiebetüren - Kasten met schuifdeuren - Armario con puertas correderas

60/61

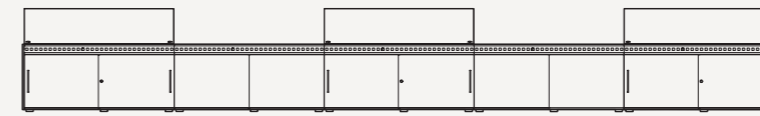

805,6 x 60 H.72 cm 317" x 23¾" H.28¼"

M10

160 x 2,1 H.37,5 cm 63" x 0¾" H.14¾"

Schermo divisorio
High screen - Écran haut - Hoher Sichtschutz - Hoog scherm - Pantalla alta

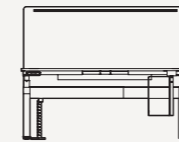

180 x 164 H.65÷130 cm 70¾" x 64½" H.25½"÷51"

Composizione Bench
Bench composition - Poste de travail - Bench-Arbeitsplatz - Samen-
stelling bench - Composición bench

175 x 4 H.86 cm 68¾" x 1½" H.33¾"

Schermo divisorio
High screen - Écran haut - Hoher Sichtschutz - Hoog scherm - Pantalla alta

For a more complete view of the collection, see the price list
Für eine vollständigere Ansicht der Sammlung finden Sie in der Preisliste
Para una visión más completa de la colección, consulte la lista de



31,8 x 56,3 H.58,7 cm 12½" x 22" H.23"

Cassetiera Slim 3 casseti
Pedestal Slim 3 drawers - Caisson Slim 3 tiroirs - 3 Schubladen Slim Container -
Ladenblok Slim 3 laden - Cajonera Slim 3 cajones

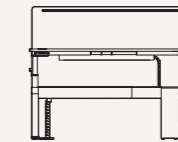

180 x 164 H.65÷130 cm 70¾" x 64½" H.25½"÷51"

Composizione Bench
Bench composition - Poste de travail - Bench-Arbeitsplatz - Samen-
stelling bench - Composición bench

Compositions elements & dimensions

62/63

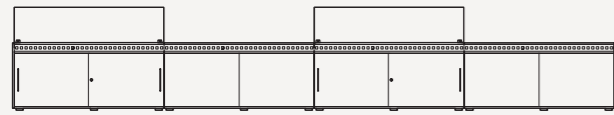

645,2 x 60 H.72 cm 254" x 23¾" H.28¼"
M10

160 x 2,1 H.37,5 cm
Schermo divisorio
High screen - Écran haut - Hoher Sichtschutz - Hoog scherm -
Pantalla alta

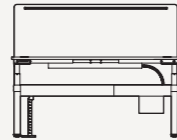

180 x 164 H.65±130 cm 70¾" x 64½" H.25½"±51"

Composizione Bench
Bench composition - Poste de travail - Bench-Arbeitsplatz - Samenstelling bench -
Composición bench

175 x 4 H.86 cm 68¾" x 1½" H.33¾"
Schermo divisorio
High screen - Écran haut - Hoher Sichtschutz - Hoog scherm - Pantalla alta

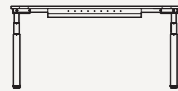

180 x 80 H.65±130 cm 70¾" x 31½" H.25½"±51"
Scrivania
Desk - Bureau - Schreibtisch - Bureau - Escritorio

64/65

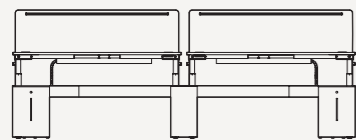

366 x 164 H.65±130 cm 144" x 64½" H.25½"±51"

Composizione Bench
Bench composition - Poste de travail - Bench-Arbeitsplatz - Samenstelling bench -
Composición bench

155 x 4 H.86 cm 61" x 1½" H.33¾"
Schermo divisorio
High screen - Écran haut - Hoher Sichtschutz - Hoog scherm - Pantalla alta

68/69

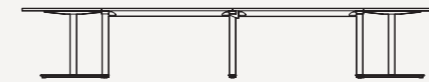

450 x 450 H.74 cm 177" x 177" H.29"

Tavolo riunione
Meeting table - Table de réunion - Konferenztisch -
Vergadertafel - Mesa de reunión

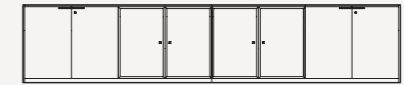

403,6 x 46 H.83 cm 158¾" x 18" H.32¾"

Armadio mod. A100
A100 Cabinet - Armoire A100 - Schränke A100 -
Kasten A100 - Armario A100

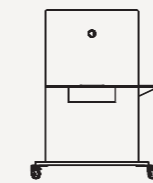

144 x 55 H.180 cm 56¾" x 21¾" H.70¾"

FLIPPER su ruote con mensola
Flipper on castors with shelf - Flipper sur roulettes avec étagère - Flipper auf Rollen
mit Konsole - Flipper op wielen met plank - Flipper sobre ruedas con estante

70/71



400 x 100 H.74 cm 157½" x 39¼" H.29"

Tavolo riunione
Meeting table - Table de réunion - Konferenztisch -
Vergadertafel - Mesa de reunión

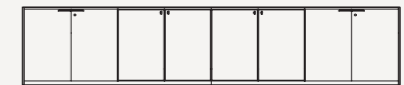

403,6 x 46 H.83 cm 158¾" x 18" H.32¾"

Armadio mod. A100
A100 Cabinet - Armoire A100 - Schränke A100 -
Kasten A100 - Armario A100

72/73 74/75



160 x 80 H.74 cm 63" x 31½" H.29"

Scrivania su ruote
Desk on castors - Bureau sur roulettes - Schreibtische auf Rollen -
Bureau op wielen - Escritorio sobre ruedas

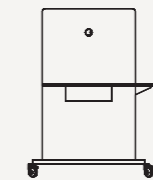

144 x 55 H.180 cm 56¾" x 21¾" H.70¾"

FLIPPER su ruote con mensola
Flipper on castors with shelf - Flipper sur roulettes avec étagère - Flipper auf Rollen
mit Konsole - Flipper op wielen met plank - Flipper sobre ruedas con estante

Compositions elements & dimensions

78/79

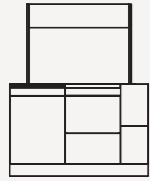

135 x 83,5 H.170 cm 53" x 32¾" H.67"

Composizione Domomag

Domomag arrangement - Composition Domomag - Domomag-Kombination - Combinatie Domomag - Composición Domomag

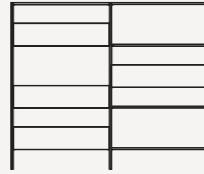

202 x 36 x 170 cm 79 ½" x 14" x H.67"

Scaffale

Shelf - Rayonnage - Regal - Boekenrek - Estantería



80 x 80 H.74 cm 31½" x 31½" H.29"

Tavolino

Small table - Petit table - Kaffeetisch
Kleine tafel - Mesa



70 x 70 H.105 cm 27½" x 27½" H.41¼"

Tavolino

Small table - Petit table - Kaffeetisch
Kleine tafel - Mesa

80/81

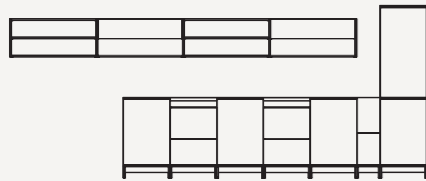

351 x 54 H.198 cm 138" x 21¼" H.78"

Composizione Domomag

Domomag arrangement - Composition Domomag - Domomag-Kombination - Combinatie Domomag - Composición Domomag



240 x 100 H.65÷130 cm 94½" x 39¼" H.25½"÷51"

Tavolo

Table - Table - Tisch
Tafel - Mesa



70 x 70 H.105 cm 27½" x 27½" H.41¼"

Tavolino

Small table - Petit table - Kaffeetisch
Kleine tafel - Mesa



Ø80 H.73÷109 cm Ø31½" H.28¾"÷43"

Tavolino

Small table - Petit table - Kaffeetisch
Kleine tafel - Mesa

Project & graphic design
marketing Bralco

3d rendered images
virtuald.it

separation
lucegroup.it

print
graficheantiga.it

edition October 2017

_Particolari tecnici, estetici, finiture o altro possono essere modificati senza preavviso.

_Product details, aesthetics, finishes or other data may be subject to change without notice.

_Les détails de produit, l'esthétique, les finitions ou d'autres données peuvent être sujets au changement sans communication préalable.

_Produktetails, Ästhetik, Ende oder andere Daten können abhängig von Änderung ohne Nachricht sein.

_De details van het product, esthetica, eindigt of andere gegevens kunnen zonder bericht voor wijzigingen vatbaar zijn.

_Los detalles del producto, la estética, los finales u otros datos pueden estar conforme a cambio sin el aviso.

Bralco s.r.l.
Via Luigi Einaudi, 1
31058 Susegana - TV
T +39 0438 43 77 11
F +39 0438 43 77 30

info@bralco.it

www.bralco.it

7MIDEWING01

Finiture - Finishes - Finitions - Oberflächen - Afwerkingen - Acabados

Melaminico - Coated panel - Mélamine - Melamin - Melamine - Melamina

BL  Bianco White Blanc Weiß Wit Blanco	MK  Nero Black Noir Schwarz Zwart Negro	RN  Rovere Naturale Natural Oak Chêne Naturel Natur Eiche Eikenhout Natuur Roble Natural	NC  Noce Canaletto Canaletto Walnut Noyer Canaletto Canaletto Nussbaum Notenhout Canaletto Nogal Canaletto	WE  Wengé Wengé Wengé Wengé Wengé Wengé	WW  wengé scuro dark wengé wengé foncé dunkel Wengé Donker wengé wengé oscuro
---	--	---	---	--	--

Laccato opaco - Matt lacquered - Lacqué mat - Matt lackiert - Matgelakt - Lacado mate

LB  Bianco White Blanc Weiß Wit Blanco	L3  Nebbia Mist Brouillard Nebelgrau Mist Niebla	L4  Titanio Titanium Titane Titan Titanium Titanio	L5  Oceano Ocean Océan Meerblau Ocean Oceano	LE  Deep Teal Deep Teal Bleu Canard Deep Teal Deep Teal Deep Teal	LF  Verde Natura Gras Green Vert Nature Grasgrün Groene Natuur Verde Natureza
L6  Verde Muschio Moss Green Vert Mousse Moosgrün Mosgroen Verde Musgo	LJ  Giallo Gold Yellow Gold Jaune Or Goldgelb Geelgouden Oro Amarillo	LN  Nero Black Noir Schwarz Zwart Negro	LA  Alluminio Aluminium Aluminium Aluminium Aluminium Aluminio	LR  Bordeaux Bordeaux Bordeaux Bordeaux Bordeaux Bordeaux	

Strutture metalliche - Metal structures - Structures métalliques - Metallstrukturen - Metalen structuren - Estructura metálicas

AF  Epoxy Alluminio Silver Epoxy Epoxy Aluminium Aluminium Aluminiumkleur Geepoaxeerd Epoxidica De Aluminio	BW  Bianco White Blanc Weiß Wit Blanco	KR  Cromo Lucido Glossy Chrome Chromé Brillant Chrom Poliert Glanzend Verchroomd Cromo Pulido
--	---	--

Finiture - Finishes - Finitions - Oberflächen - Afwerkingen - Acabados

Tessuto - Fabric - Tissu - Stoff - Stof - Tejido

Puma A + B	PV  Verde Mela Apple Green Vert Pomme Apfelgrün Appelgroen Verde Manzana	P4  Bordeaux Bordeaux Bordeaux Bordeaux Bordeaux Bordeaux	P8  Blu Dark Blue Bleu Blau Blauw Azul	P2  Grigio Medio Medium Grey Gris Moyen Mittelgrau Gewoon Grijs Gris Hormigón	PG  Grigio Scuro Dark Grey Gris Foncé Dunkelgrau Donkergrijs Gris Oscuro	P1  Nero Black Noir Schwarz Zwart Negro
	P5  Bianco White Blanc Weiß Wit Blanco					
Lucia A + B	A1  Sabbia - Aruba Sable - Aruba Sable - Aruba Sandfarbe - Aruba Zand - Aruba Arena - Aruba	A2  Matrone - Jamaica Brick-Coloured - Jamaica Brique - Jamaica Ziegelrot - Jamaica Baksteen - Jamaica Pardo Cobre - Jamaica	A3  Celeste - Arecibo Light Blue - Arecibo Bleu - Arecibo Hellblau - Arecibo Hemelsblauw - Arecibo Azul Celeste - Arecibo	A4  Blu - Martinique Blue - Martinique Bleu - Martinique Blau - Martinique Blauw - Martinique Azul - Martinique	A5  Petrolio - Windjammer Petroleum - Windjammer Pétrole - Windjammer Petroleum Blau - Windjammer Petroleum - Windjammer Petroleo - Windjammer	A6  Testa Di Moro - Sombrero Dark Brown - Sombrero Brun Gris - Sombrero Dunkelbraun - Sombrero Donkerbruin - Sombrero Pardo Grisáceo - Sombrero
Stay B	Y1  Giallo Yellow Jaune Gelb Geel Amarillo	Y2  Arancio Orange Orange Orange Oranje Naranja	Y3  Verde Green Vert Grün Groen Verde	Y4  Celeste Light Blue Bleu Hellblau Hemelsblauw Azul Celeste	Y5  Blu Avio Air Force Blue Bleu Aviation Avio Blau Avio-Blauw Azul Colomino	Y6  Grigio Londra London Grey Gris Londres London Grau Londen-Grijs Gris Londres
Xpress B	X1  Giallo Primavera Spring Yellow Jaune Printemps Frühling Gelb Lentegeel Amarillo Primavera	X2  Verde Sotobosco Underwood Green Vert Sous-Bois Unterholz Grün Bosgrond-Groen Verdes Sotobosque	X3  Blue Jeans Blue Jeans Denim Blue Blue Jeans Blau Jeansblauw Azul Denim			

A	B
Per sedute	Per schermi
For armchair	For screens
Pour les chaises	Pour écrans
Für Stühle	Für Schirmwände
Voor stoelen	Voor schermen
Para las sillas	Para las pantallas

