

ESSE SOLUTION_{SAGL}

FORNITURE AZIENDALI

Via Rompada, 37 - CASLANO

+41 076 758 5368 +41 079 709 8354

www.essesolution.ch info@essesolution.ch

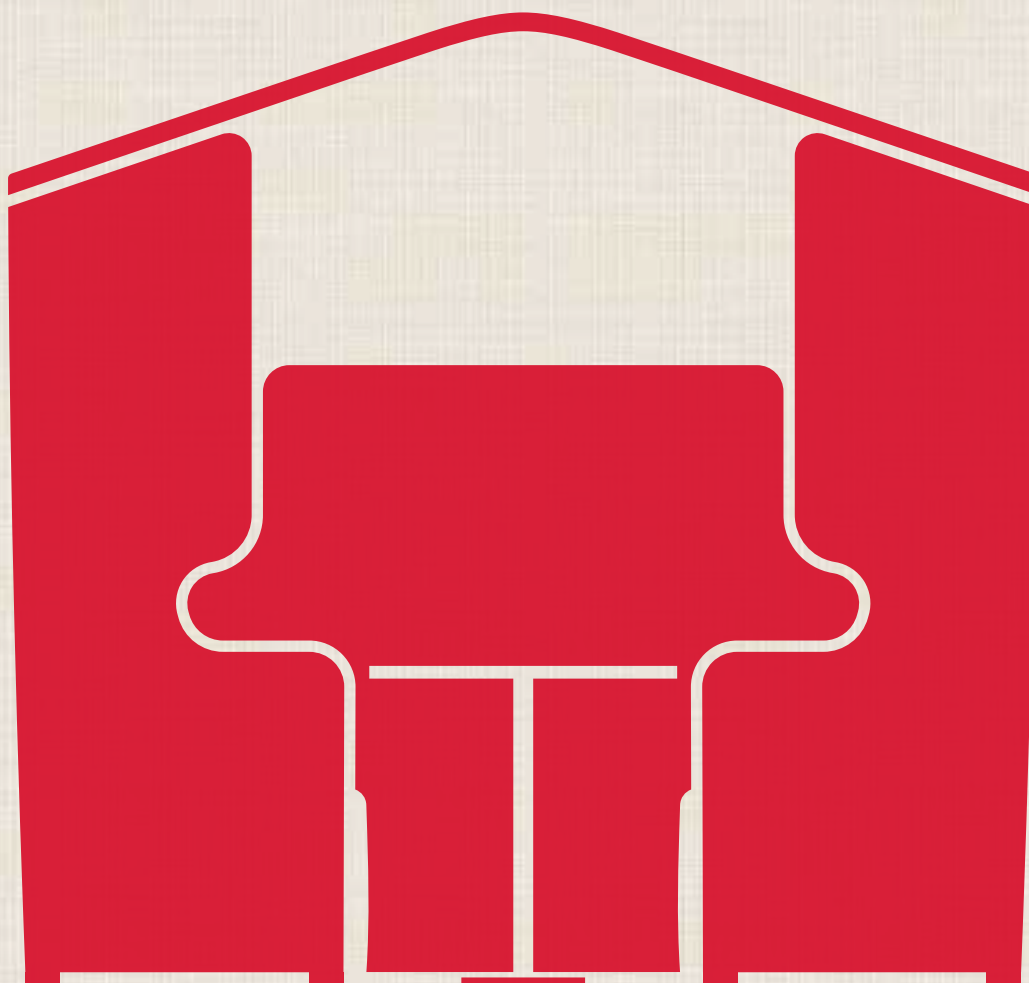

catalogo 2022

catalogo
2022
executive
operative
contract
wait
elements

ESSE SOLUTION_{S A G L}

FORNITURE AZIENDALI

Via Rompada, 37 - CASLANO

+41 076 758 5368 +41 079 709 8354

www.essesolution.ch info@essesolution.ch

ESSE SOLUTION_{SAGL}

FORNITURE AZIENDALI

Via Rompada, 37 - CASLANO

+41 076 758 5368 +41 079 709 8354

www.essesolution.ch info@essesolution.ch

Progetti per un mondo nuovo.

Reinventare se stessi come risposta a un mondo cambiato rapidamente. Incoraggiati dall'etica sostenibile, abbiamo allargato la nostra visione sugli spazi contract, office e home office con uno sguardo ambizioso e contemporaneo.

Projects for a new world.

Reinvent ourselves as an answer to a rapidly changing world. Encouraged by sustainable ethics, we have broadened our vision on collaborative spaces, office and home office at an ambitious and contemporary glance.

Projets pour un nouveau monde.

Réinventer nous comme réponse à un monde en évolution rapide. Encouragés par une éthique durable, nous avons élargi notre vision des espaces détente, bureau et bureau à domicile en un coup d'œil ambitieux et contemporain.



Novità

ESSE SOLUTION S.p.A.

FORNITURE AZIENDALI

Via Rompada, 37 - CASLANO

+41 076 758 5368 +41 079 709 8354

www.essesolution.ch info@essesolution.ch



People home

Ampliamento della gamma People con tetto e illuminazione incorporata. Disponibile con pannello alto o basso.

Extension of the People range in the version with roof and built-in lighting. Available with high or low panel.

Extension de la gamme People dans la version avec toit et éclairage intégré. Disponible avec panneau haut ou bas.



Quiet

Moduli componibili caratterizzati da schienali e braccioli double face e doppia altezza schienale.

Composable modules characterized by double-sided backrests and armrests and a double-height backrest.

Modules componibles caractérisés par des dossiers et accoudoirs à double face et le dossier à double hauteur.



Mi chair

Poltroncina con sinuoso bracciolo in alluminio, completata da un'ampia gamma di basi.

Armchair with sinuous aluminum armrest, completed by a wide range of bases.

Fauteuil avec sinueux accoudoir en aluminium, complété par une vaste gamme de piètements.



People work

Versione privacy con scrivania, che garantisce l'isolamento necessario in ambienti open space.

Pod version with its individual desk, that guarantees the privacy required for open-space environments.

Version à cellule avec bureau, qui garantit l'isolement nécessaire dans des espaces ouverts.



Beth

Sistema contract composto da poltroncina, divanetto e lounge di dimensioni generose e forme tondeggianti.

Soft seating series of armchair, sofa and lounge chair with generous dimensions and rounded shapes.

Série contract de fauteuil, canapé et lounge aux dimensions généreuses et aux formes arrondies.



Bakku

Sistema di imbottiti modulare, composto da quattro pouf, uno schienale e un tavolino.

Collection of four ottomans that allows to create relax islands within community spaces.

Collection de quatre poufs qui permet de créer des îlots de détente au sein d'espaces contract.



Plot

Serie di pannelli fonoassorbenti rivestiti in tessuto, disponibili da terra e da parete.

Line of fabric upholstered sound absorbing screens, available for wall fixing or self standing.

Ligne de panneaux phono absorbants en tissu, disponibles pour fixation aux murs ou debout.

Il pianeta è una casa condivisa. Noi la arrediamo, con rispetto.

In Milani ci avviciniamo alla sostenibilità con un atteggiamento concreto. Non ci fermiamo alla scelta di tessuti eco-friendly, ma includiamo asset organizzativi che riducono il nostro impatto sul pianeta. Dalla progettazione alla realizzazione ci impegniamo per una produzione responsabile, scegliendo colori e materiali che resistono al tempo e alle mode.

The planet is a shared home. We furnish it, with respect.

At Milani, we approach sustainability with a concrete attitude, which does not stop at selecting eco-friendly fabrics, but includes organizational assets that reduce our impact on the planet. From design to construction we are committed to responsible production, choosing colors and materials that resist time and trends.

La planète est une maison partagée. Nous l'ameublons, avec respect.

Chez Milani, nous abordons la durabilité avec une attitude concrète, qui ne s'arrête pas au choix de tissus respectueux de l'environnement, mais comprend des atouts organisationnels qui réduisent notre impact sur la planète. De la conception à la construction, nous nous engageons pour une production responsable, en choisissant des couleurs et des matériaux qui résistent au temps et aux tendances.



Una ricerca a favore dell'ambiente.

11

REVIVA
from plastic to textile

SEAQUAL
INITIATIVE

Il tessuto IR REVIVA si ottiene da un filato realizzato riciclando le bottiglie di plastica. Con il recupero di 500 bottiglie produciamo il tessuto necessario per rivestire un divano a tre posti, consumando il 94% in meno di acqua, il 64% in meno di energia e riducendo del 32% le emissioni di CO².

Il tessuto SE SEAQUAL® è un filato di alta qualità, realizzato al 100% in poliestere riciclato e ottenuto dalla SEAQUAL INITIATIVE recuperando la plastica dispersa in mare. Ha le stesse proprietà tecniche del poliestere vergine, ma contiene il 10% di plastica riciclata da rifiuti marini e il 90% da PET post-consumo.

A research in favour of the environment.

The IR REVIVA fabric is obtained from the recycling of plastic bottles. From recovery of 500 bottles we produce the necessary fabric to cover a three-seater sofa, consuming 94% less water, 64% less energy and reducing CO² emissions by 32%.

The SE SEAQUAL® fabric is a high quality 100% post-consumer recycled polyester yarn containing Upcycled Marine Plastic from SEAQUAL INITIATIVE. It is almost identical in physical properties to virgin polyester and contains 10% Upcycled Marine Plastic (from plastic marine litter), the remaining 90% is post-consumer PET from land sources.

Une recherche en faveur de l'environnement.

Le tissu IR REVIVA est obtenu à partir d'un fil manufacturé du recyclage des bouteilles en plastique. De la récupération de 500 bouteilles nous produisons le tissu nécessaire pour recouvrir un canapé trois places, en consommant 94% d'eau en moins, 64% de moins d'énergie et réduction des émissions de CO² de 32%.

Le tissu SE SEAQUAL® est un tissu de 100% polyester post-consommation contenant plastique marine récupéré de l'INITIATIVE SEAQUAL. Il est presque identique aux propriétés physiques du polyester vierge et il contient 10% de plastique marine récupéré (à partir des déchets marins en plastique) et 90% de PET post-consommation des sources terrestres.



L'ufficio cambia forma.

Lo scenario lavorativo è stato reinventato per sempre. Postazioni flessibili, spazi di collaborazione e intime nicchie definiscono gli uffici di oggi e di domani. In questo contesto, abbiamo allargato la famiglia People con prodotti che permettono di ritrovare la tranquillità senza allontanarsi dagli ambienti collettivi. È possibile ritirarsi in videochiamate, godere dei momenti di pausa o organizzare riunioni in un ambiente confortevole e protetto.

The office changes shape.

The business scenario has been reinvented forever. Flexible workstations, collaboration spaces and intimate niches define the offices of today and tomorrow. In this context, we have expanded the People family with products that allow you to find tranquility without moving away from collective environments. It's possible to isolate for video calls, enjoy break moments or organize meetings in a comfortable and protected environment.

Le bureau change de forme.

Le monde professionnel a été réinventé à jamais. Postes de travail flexibles, espaces de collaboration et niches intimes définissent les bureaux d'aujourd'hui et de demain. Dans ce contexte, nous avons élargi la famille People avec des produits qui vous permettent de retrouver la tranquillité sans vous éloigner des environnements collectifs. Il est possible de s'isoler pour des appels vidéo, bénéficier de moments de détente et organiser des rendez-vous en un environnement confortable et protégé.



Sistemi agili per spazi che si trasformano.

Concentrandoci sui sistemi abbiamo realizzato famiglie di prodotto estremamente versatili, che si adattano a seconda delle specifiche esigenze del progetto. Sono sistemi flessibili, pensati per spazi contract e office che cambiano nel tempo.

Systems for fast-changing spaces.

By concentrating ourselves on systems we have created extremely versatile product families, that adapt themselves based on the specific needs of the project. They are flexible systems conceived for contract and office spaces that change along time.

Systèmes pour des espaces en évolution rapide.

En nous concentrant sur des systèmes, nous avons créé des familles de produits extrêmement polyvalentes, qui s'adaptent en fonction des besoins spécifiques du projet. Ce sont des systèmes flexibles conçus pour les espaces contract et les bureaux qui évoluent au fil du temps.



Focus sulla qualità della vita: stare bene.

18

Progettiamo per il benessere delle persone. Ogni collezione che proponiamo nasce per fare entrare in sintonia l'uomo con l'ambiente che lo circonda, un legame autentico che si sviluppa attorno all'idea di comfort. Stare bene oggi significa adottare forme e finiture che esaltano la comodità, prestando un'attenzione particolare all'isolamento acustico, elemento fondamentale per rendere uno spazio accogliente, pratico ed efficiente.

Focus on the quality of life.

We design for people's well being. Each collection that we propose is born to make the person get in tune with the environment that surrounds him, an authentic bond that is connected to the idea of comfort. Being well today means adopting shapes and finishes that exalt the comfort, paying particular attention to the acoustic isolation, basic element for making a space cosy, practical and efficient.

Focus sur la qualité de la vie.

Nous concevons pour le bien-être des personnes. Chaque collection que nous proposons est née pour mettre la personne en harmonie avec l'environnement qui l'entoure, un lien authentique qui se développe autour de l'idée de confort. Être bien aujourd'hui signifie adopter des formes et des finitions qui exaltent le confort, en accordant une attention particulière à l'isolation acoustique, élément de base pour rendre un espace confortable, pratique et efficace.

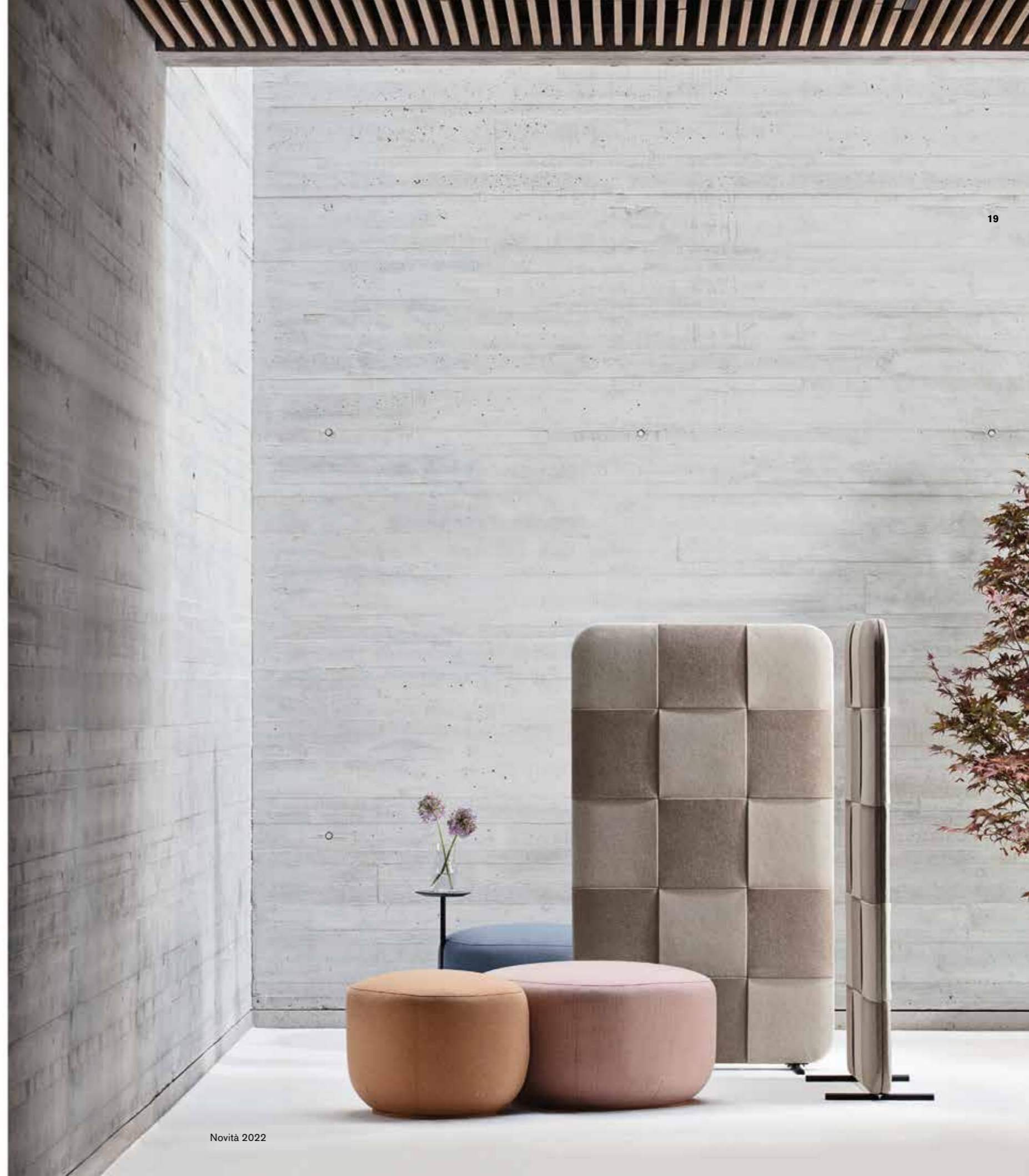

19



Il legame tra design, comfort e benessere.



NE antibatterico NE è un tessuto ignifugo antimicrobico, adatto per tutte le strutture pubbliche. È prodotto con un filato TREVIRA CS Bioactive, dove ioni di argento contrastano la propagazione dei batteri. Il risultato è permanente e rimane inalterato anche dopo numerosi lavaggi o un uso prolungato.

The link between design, comfort and well-being.

NE antibacteric NE is a fire retardant antimicrobial fabric, suitable for all public spaces. It's made of TREVIRA CS Bioactive yarn, where silver ions contrast the spread of bacteria. The result is permanent and remains unaltered even after several washes or a prolonged use.

La lien entre design, confort et bien-être.

NE antibactérien NE est un tissu antimicrobien ignifuge, adapté à tous les espaces publics. Il est produit du fil TREVIRA CS Bioactive, où les ions d'argent contrastent la propagation des bactéries. Le résultat est permanent et reste inchangé même après plusieurs lavages ou une utilisation prolongée.



Certificazioni acustiche L'isolamento acustico è fondamentale per vivere al meglio gli spazi in comune, andando a migliorare il benessere e la privacy delle persone. Per questo abbiamo diversi prodotti certificati sia in acustica che in assorbimento, ideali da inserire nel progetto contract contemporaneo.

Acoustic certifications Acoustic isolation is essential to better enjoy the open spaces, improving people's well-being and privacy. For this reason we have several certified products both in acoustics and in sound absorption, ideal to be included in the contemporary contract projects.

Certifications acoustiques L'isolation acoustique est essentielle pour mieux profiter des espaces ouverts, améliorant le bien-être et l'intimité des personnes. Pour cette raison, nous avons plusieurs produits certifiés à la fois en acoustique et en absorption acoustique, idéaux pour être inclus dans les projets contract contemporains.

3

showroom
showrooms
showrooms

Venezia,
Londra,
Milano

112

paesi d'esportazione
export countries
pays d'exportation

113.000

sedute/anno
chairs/year
sièges/ans

70

modelli
designs
modèles

375

finiture
finishes
finitions

3

certificazioni aziendali
quality certifications
certifications d'entreprise

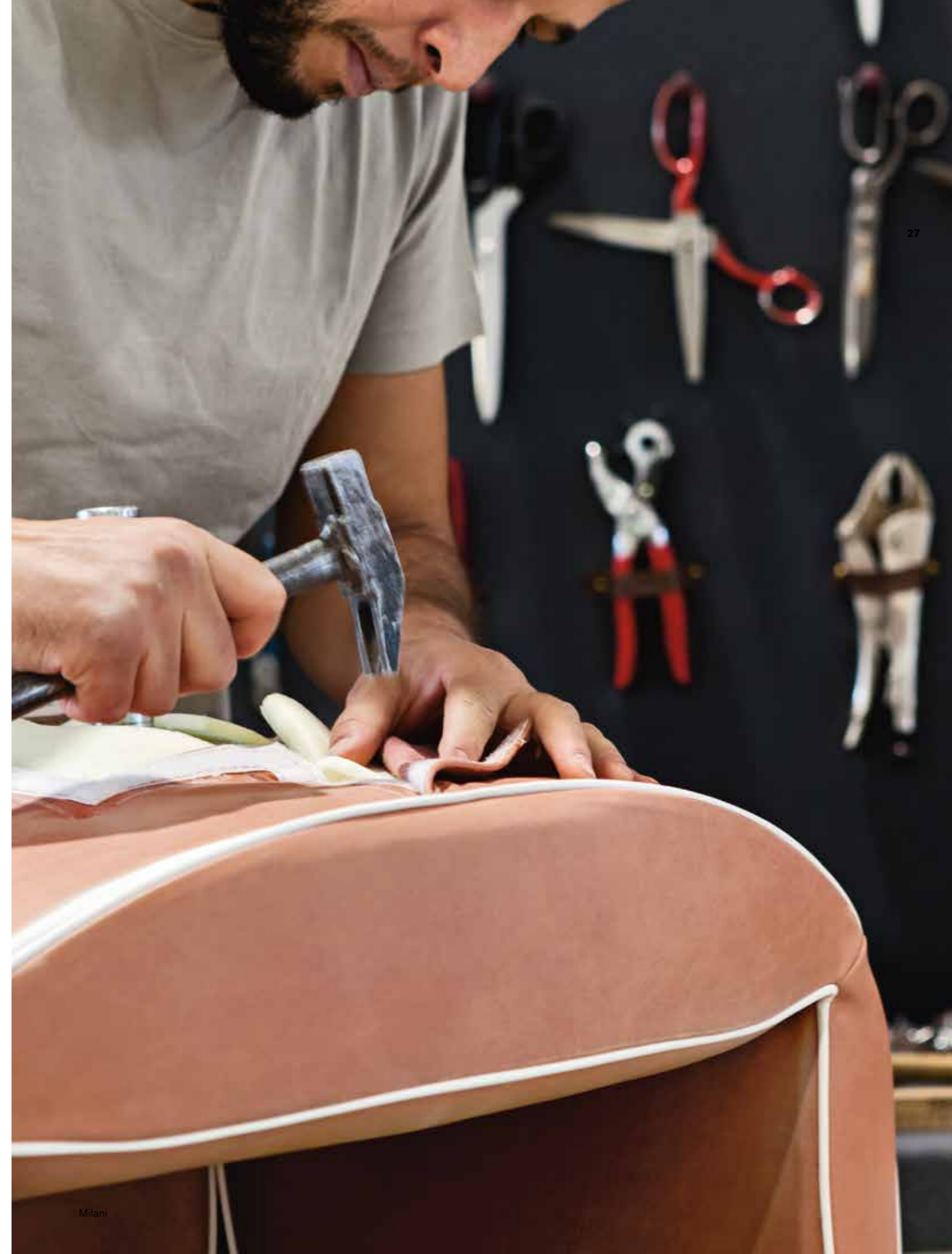

→ p. 33 **executive**

nordic → p. 36

x-chair → p. 46

celine → p. 56

olite → p. 64

sky soft → p. 70

sky ten → p. 70

sky mesh → p. 70

andy → p. 80

sally → p. 84

rang → p. 86

→ p. 89 **operative**

tam → p. 92

loop → p. 100

zed → p. 108

five → p. 118

lex → p. 120

→ p. 133 **contract**

nordic → p. 136

people → p. 144

people home → p. 156

people work → p. 164

nuvola → p. 170

beth → p. 180

quiet → p. 190

bakku → p. 200

shock → p. 208

nesis → p. 214

nesis chic → p. 218

cocktail → p. 222

daisy → p. 226

only → p. 230

mi chair → p. 234

mirò → p. 246

ellipse → p. 256

lilie → p. 260

adalia → p. 264

terre → p. 268

fungus → p. 272

plot → p. 276

→ p. 285 **wait**

voilà → p. 288

clark → p. 294

lois → p. 302

role → p. 308

dolly → p. 312

wendy → p. 318

venice → p. 324

sofa and modules sizes → p. 328

→ p. 333 **elements**

→ p. 347 **designers**

product overview

e

executive



nordic
p. 36



x-chair
p. 46



celine
p. 56



olite
p. 64

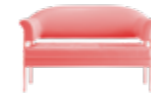

daisy
p. 226



only
p. 230



mi chair
p. 234



mirò
p. 246



ellipse
p. 256



sky soft
p. 70



sky ten
p. 70



sky mesh
p. 70



andy
p. 80



sally
p. 84



lilie
p. 260



adalia
p. 264



terre
p. 268



fungus
p. 272



plot
p. 276



rang
p. 86

O

operative



tam
p. 92



loop
p. 100



zed
p. 108

W

wait



voilà
p. 288



clark
p. 294



lois
p. 302



role
p. 308



five
p. 118



lex
p. 120

C

contract



nordic
p. 136



people
p. 144



dolly
p. 312



wendy
p. 318



venice
p. 324



people home
p. 156



people work
p. 164



nuvola
p. 170



beth
p. 180



quiet
p. 190



bakku
p. 200



shock
p. 208



nesis
p. 214



nesis chic
p. 218



cocktail
p. 222



executive



nordic
p. 36



x-chair
p. 46



celine
p. 56



olite
p. 64



sky soft
p. 70



sky ten
p. 70



sky mesh
p. 70



andy
p. 80



sally
p. 84



rang
p. 86

poltrone direzionali

Serie di poltrone direzionali che arredano con stile i diversi ambienti ufficio, da quelli contemporanei a quelli più classici. L'ampia gamma di proposte consente di spaziare tra i modelli dalle forme ad alto contenuto tecnico-ergonomico a quelle più tradizionali, dotate di dettagli e finiture che le rendono attuali. Il disegno e la qualità dei materiali impiegati esalta la lavorazione artigianale made in Italy.

executive chairs

A series of executive chairs that will bring style to the furnishings of different office environments, from contemporary to traditional. The wide range of options includes models offering high technical and ergonomic performance to more traditional designs with details and finishes that make them more contemporary. The design and the quality of the materials used showcases the finest Italian craftsmanship.

fauteuils de direction

Cette série de fauteuils de direction meuble avec style les différents espaces du bureau, du plus moderne au plus classique. Une vaste gamme qui s'étend des modèles aux formes hautement techniques et ergonomiques à d'autres, plus traditionnelles, aux détails et finitions qui les rendent très actuels. Le design et la qualité des matériaux utilisés met en valeur la réalisation artisanale 100% italienne.

designers

Baldanzi & Novelli
Alessandro Crosera
R&D Milani



designer
Baldanzi & Novelli

it Una collezione di poltrone presidenziali – ergonomiche e leggere – dal caratteristico sedile curvo, declinata anche nella versione contract con panche, poltrone e divani. La seduta rivestita in pelle o tessuto, in un’ampia gamma di colori, è disponibile in tre diverse altezze. Il meccanismo sincronizzato può essere incorporato nella scocca.

en A collection of executive chairs – ergonomic and light – with a characteristic curved seat, also available in contract version with benches, armchairs and sofas. The armchair, which comes in leather or fabric and in a wide range of colours, is available in three different backrest heights. A synchronised tilt mechanism can be incorporated into the frame.

fr Cette collection de fauteuils président, légers et ergonomiques, affiche une caractéristique assise courbe et se décline également en version détente, avec des banquettes, des fauteuils et des canapés. Le fauteuil, revêtu en cuir ou en tissu, est disponible dans une large gamme de coloris et dans trois différentes hauteurs de dossier. Le mécanisme synchrone peut être intégré à la structure.



finishes
1. FE 0601 / FE 0302 + Rubelli
Cortez CZ 0013 / 3. FE 0602



finishes
1. FE 0601 / 2. FE 0603



finishes
 Kvadrat Remix 3 MX 0722 + MX 0612



finishes

1. LN 3364 / 2. FE 0603





finishes
 1. LN 5478 / 2. LN 3364

x-chair

46



designer
R&D Milano

it Poltrona dalle grandi qualità ergonomiche e molteplici dettagli tecnici per la massima personalizzazione. Proposta con schienale in rete nera, inserti in alluminio lucido e traslatore di seduta, con o senza poggiatesta. Il supporto lombare è regolabile in altezza e profondità, i braccioli sono regolabili in 3D.

en A high-performance ergonomic chair with multiple technical features to give the ultimate in customisability. Available with a black mesh backrest, polished aluminium inserts and sliding seat adjustment, with or without headrest. The lumbar support is height and depth-adjustable, and the armrests are 3D adjustable.

fr Fauteuil aux grandes qualités ergonomiques et aux nombreux détails techniques, pour une personnalisation extrême. Il possède un dossier en résille noire, des inserts en aluminium poli et le système de translation d'assise, avec ou sans appuie-tête. Le soutien lombaire est réglable en hauteur et en profondeur, et les accoudoirs sont réglables en trois dimensions.

47



finishes
1. LN 2500 / 2. LN 2335



finishes
1. LN 0443 / 2. LN 2527 / 3. LN 3348



it X-chair operativa,
caratteristiche tecniche.
en Operator X-chair,
technical characteristics.
fr Siege de travail X-chair,
caractéristiques techniques.



it Poggiatesta regolabile
in altezza e orientamento.
en Height and orientation
adjustable padded headrest.
fr Appui-tête réglable
en hauteur et orientable.

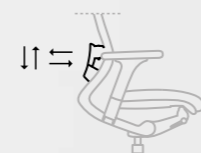

it Supporto lombare regolabile
in altezza e in profondità.
en Height and depth
adjustable lumbar support.
fr Soutien lombaire réglable
en hauteur et profondeur.

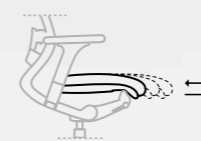

it Traslatore di seduta.
en Sliding seat.
fr Translation d'assise.



it Meccanismo sincronizzato
con tre limitazioni di corsa
e regolazione laterale.
en Synchronized mechanism
with three limitation tilt positions
and side tension.
fr Mécanisme synchrone avec
trois limitations de basculement
et régulation latérale.

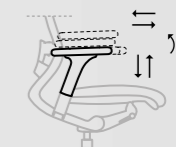

it Braccioli regolabili in
3D con pads in PU morbido.
en 3D adjustable armrests
with soft PU pads.
fr Accoudoirs réglables en 3D
avec manchettes en PU souple.

it Sedile in schiumato amovibile.
en Removable injected
foam seat pad.
fr Assise amovibile
en mousse injectée.



it Regolazione
positiva del sedile.
en Positive tilt action.
fr Régulation
positive de l'assise.



finishes
MI 6015



finishes
LN 2500

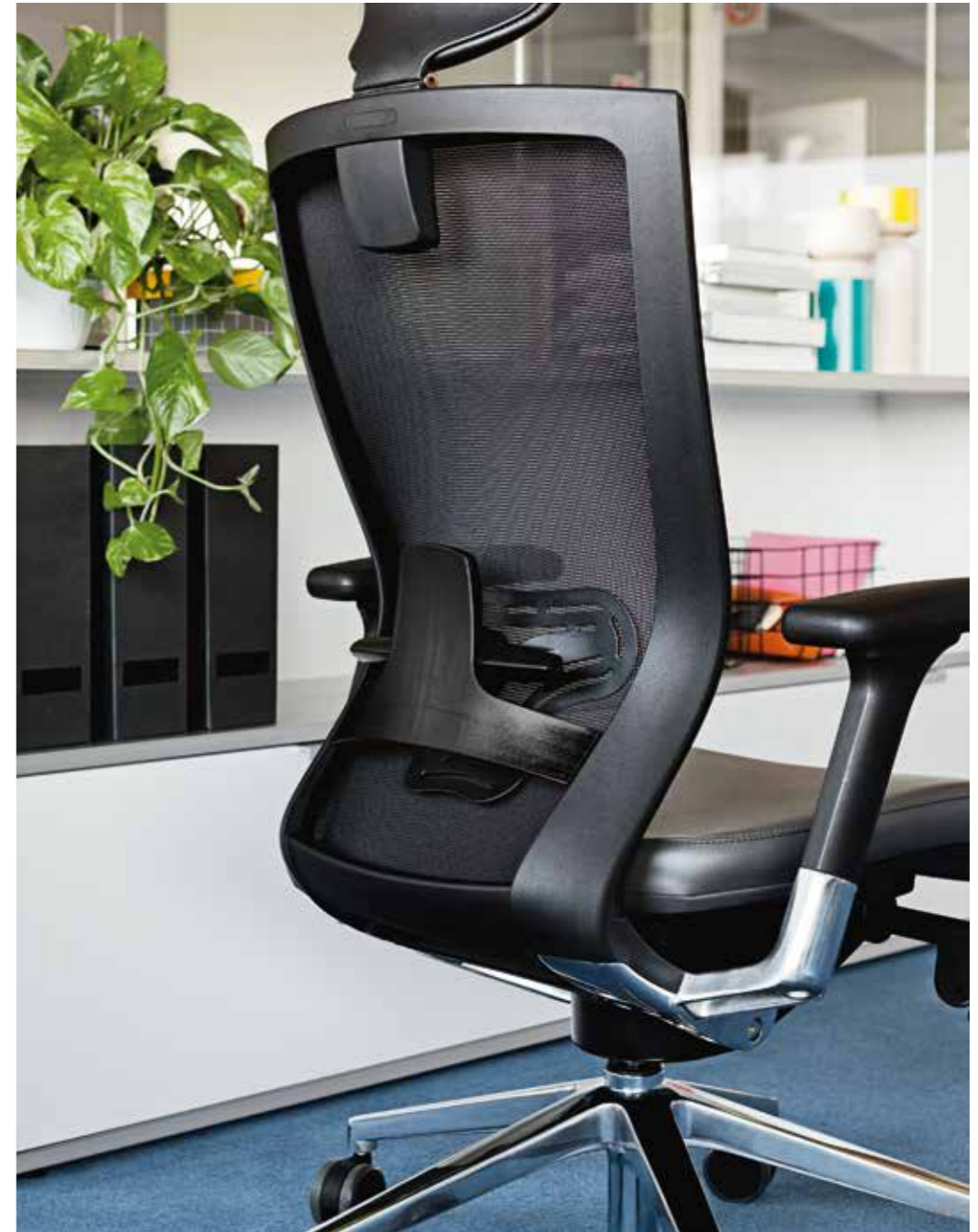

finishes
1. MA 0304 / 2. LN 2500

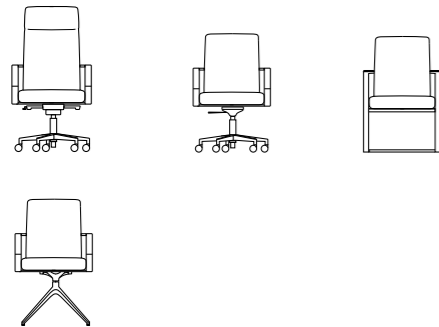

designer
R&D Milani

it Comoda poltrona dallo stile ricercato. Lo schienale è proposto in versione imbottita liscia o con lavorazione plissettata. I braccioli in alluminio lucido con rivestimento permettono il movimento di oscillazione sincronizzata.
en A comfortable, stylish chair. The backrest is available in smooth padding or with a pleated finish. The polished aluminium armrests with upholstered pads allow the chair's synchronized movement.
fr Fauteuil confortable au style recherché. Son dossier est disponible en version rembourrée lisse ou plissée. Les accoudoirs en aluminium poli revêtus permettent de déclencher le mouvement d'oscillation synchrone.

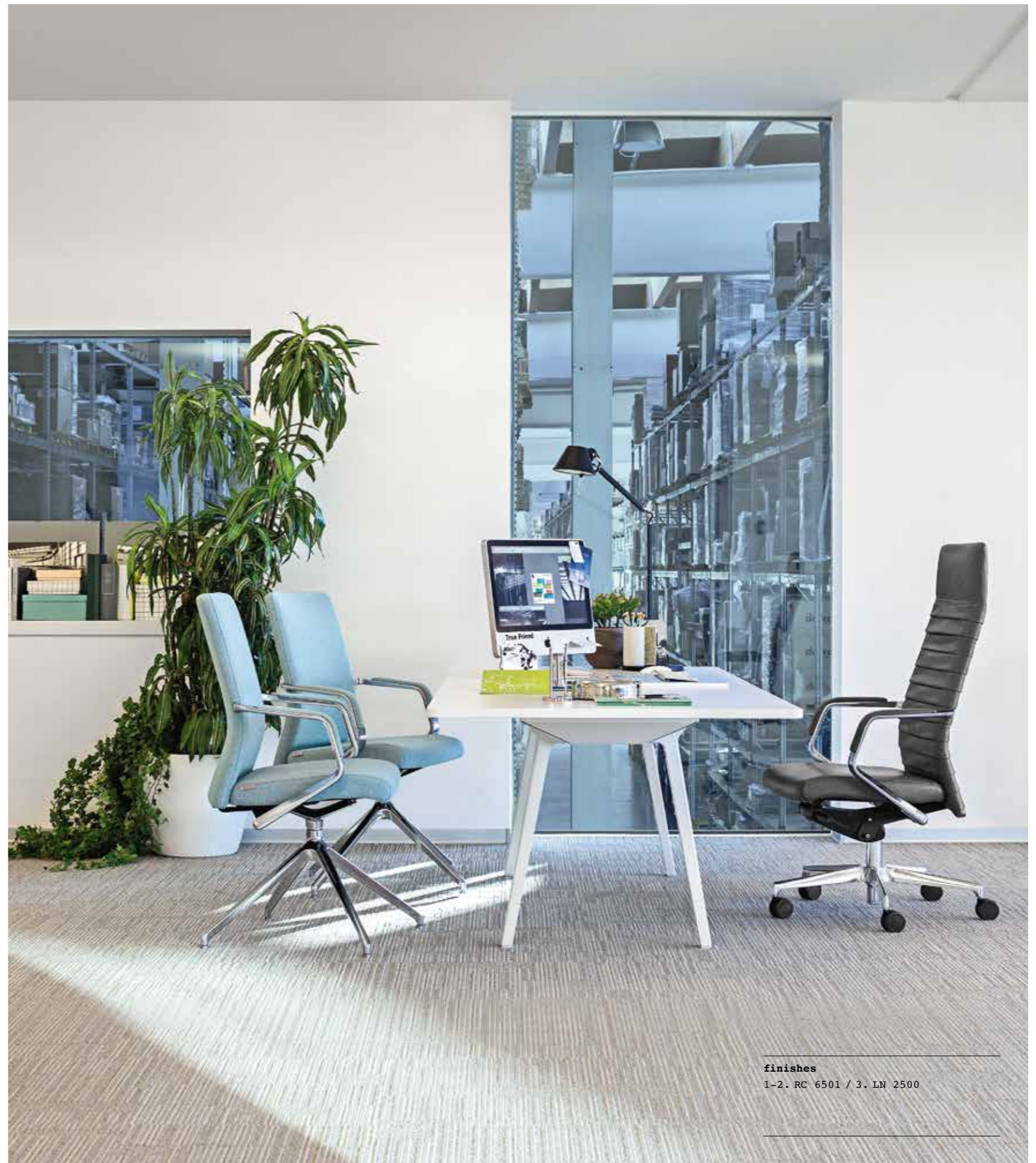

finishes
1-2. RC 6501 / 3. LN 2500



it_Celine, caratteristiche tecniche.
 en_Celine, technical characteristics.
 fr_Celine, caractéristiques techniques.

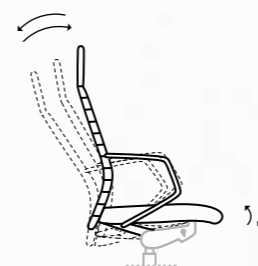

it_Meccanismo sincronizzato con cinque posizioni di blocco e regolazione laterale.
 en_Five locking positions synchronized mechanism with side tension control.
 fr_Mécanisme synchrone avec cinq positions de blocage et régulation latérale.



it_Traslatore di seduta.
 en_Sliding seat.
 fr_Translation d'assise.

finishes

1. RC 6501 / 2. ZS 02F1



finishes

1. LN 2523 / 2-3. LN 5432



finishes
1. ZS 02E8 / 2. SL 3030 / 3. ZS 02E8

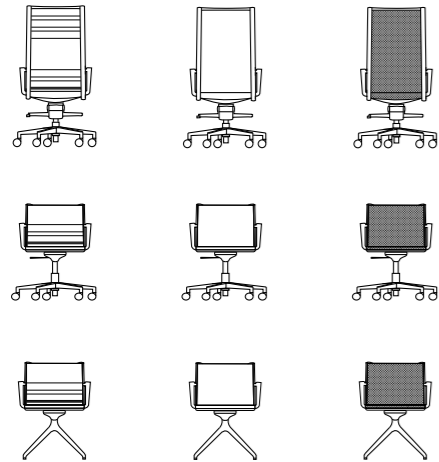

designer
R&D Milani

it Dalla perfetta combinazione tra comfort e funzionalità nasce Olite. Con rivestimento in rete traspirante e lavabile, in pelle o in tessuto autoportante, è possibile scegliere tra una struttura in alluminio lucido o alluminio verniciato nero opaco.

en Olite is the perfect combination of comfort and functionality. It can be upholstered in breathable, washable mesh, in leather or in tensile fabric, while the frame comes in polished aluminium or matt black painted aluminium.

fr Olite naît d'une union parfaite entre confort et fonctionnalité. Avec son revêtement en résille respirant et lavable, en cuir ou en tissu autoportant, vous pourrez choisir entre une structure en aluminium poli ou en aluminium verni noir mat.



finishes
KT 0060



finishes
CM 0900



finishes
1. KT 0060



finishes
2-3. LN 2511

sky soft, sky ten, sky mesh

70



A. Sky soft



B. Sky ten

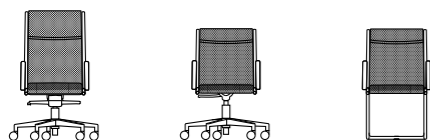

C. Sky mesh

designer
R&D Milano

it La linea sinuosa della struttura portante cromata o nera, priva di viti laterali, caratterizza la collezione. Le sedute sono proposte nella versione a rete, imbottita con cuciture orizzontali o con morbidi cuscini. Lo schienale può essere alto o medio e con base a slitta.

en The sinuous lines of the chrome or black framework with no side frame screws, define this collection. These chairs are available in a mesh, padded version with horizontal stitching, or with soft cushions. The backrest can be high or medium and with cantilever base.

fr La ligne sinueuse de la structure chromée ou noire, sans vis latérales, caractérise cette collection. Ces sièges sont disponibles dans une version résille, rembourrée à coutures horizontales, ou à coussins. Le dossier peut être haut ou bas et à piétement luge.

71



finishes sky ten
MA 0706



finishes

1-2. RC 4504 / 3. ER 0041



finishes

1. RT 0015 / 2. RT 0024 /
3-4. RT 0014



finishes sky mesh, sky ten, sky soft
 1. RT 0024 / 2. ML 0002 / 3. MI 8011

it_Profilii cromati senza viteria.
 en_Screwless side frame.
 fr_Profils chromés sans vis.



finishes sky ten
 4. MA 0706

executive – sky soft, sky ten, sky mesh



finishes sky soft
1. NE 0411 / 2-3. NE 0573

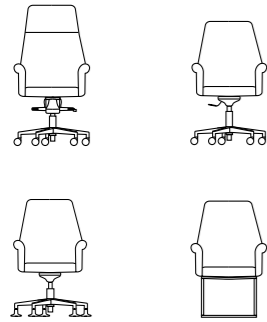

designer
Alessandro Crosera

it Poltrona dedicata agli ambienti ufficio classici e importanti. I braccioli formano un tutt'uno con la seduta. La cucitura a croce, opzionale, dona ulteriore pregio al modello.
en A chair specifically designed for traditional, imposing offices. The armrests form a complete unit with the seat. Optional cross-stitching lends the model extra prestige.
fr Fauteuil conçu pour les espaces de bureau classiques et d'envergure. Les accoudoirs ne font qu'un avec le siège. La couture croisée, en option, donne une touche raffinée au modèle.



finishes
1. LN 2000 / 2. LN 0443



finishes

1-2. LN 3348 + RC 8501

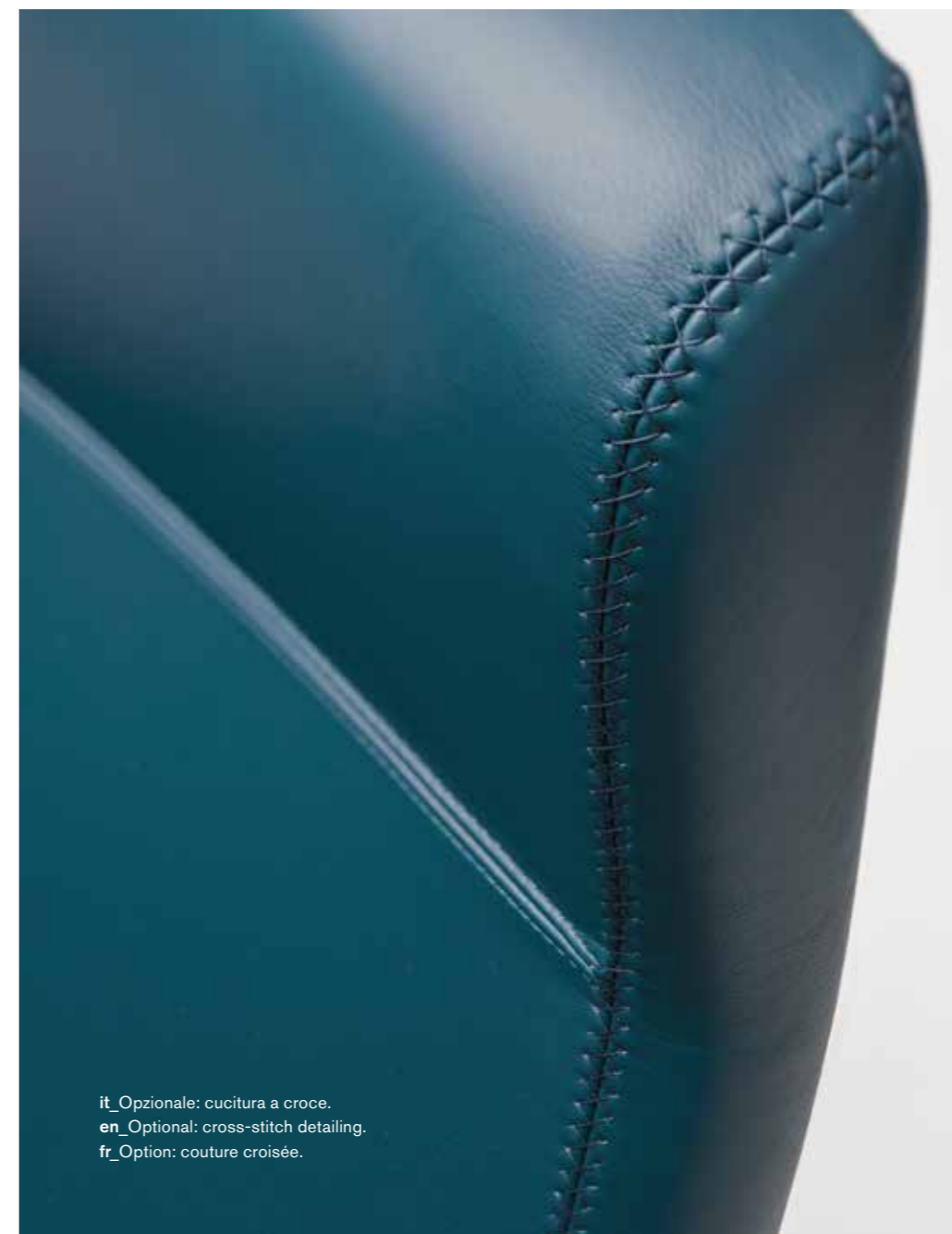

it_Optionale: cucitura a croce.
en_Optional: cross-stitch detailing.
fr_Option: couture croisée.

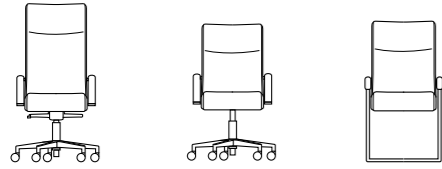

designer
R&D Milani

it Poltrona classica dalle dimensioni generose e grande comfort. È disponibile con schienale alto, medio e nella versione visitatore a slitta.

I braccioli sono completamente rivestiti.
en Classic seat offering generous dimensions and outstanding comfort. Available in high-back and medium-back versions and cantilever visitor version. The armrests are fully upholstered.

fr Fauteuil classique qui allie belles dimensions et grand confort. Disponible avec dossier haut, moyen et à piétement luge dans la version visiteur. Les accoudoirs sont complètement revêtus.



finishes
1. LN 2500 / 2. LX 0026 / 3. LN 2523

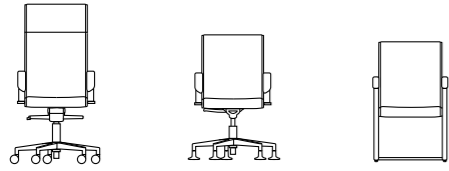

designer
R&D Milani

it Seduta caratterizzata da una sottile imbottitura ad alta densità. Disponibile nella versione presidenziale, direzionale e visitatore con braccioli costituiti da una struttura in acciaio rivestita.

en A seat distinguished by its thin, high-density padding. Available in presidential, executive and visitor versions with upholstered steel armrests.

fr Siège caractérisé par un rembourrage fin et à haute densité. Disponible en version président, direction et visiteur avec des accoudoirs en acier revêtu.



finishes
1. ZS 06ME / 2. ZS 05L1 / 3. ZS 04L1



operative



tam
p. 92



loop
p. 100



zed
p. 108



five
p. 118



lex
p. 120

sedute operative

Una collezione di comode sedute, versatili e innovative. Le caratteristiche ergonomiche sono certificate dai numerosi standard internazionali. Le molteplici opzioni funzionali consentono di assecondare le diverse esigenze per una postazione lavorativa personalizzata.

operative chairs

A collection of innovative chairs designed for comfort and versatility. The ergonomic features of this collection meet a number of international quality standards. The numerous optional features allow individual needs to be met, giving a personalised work station.

sièges de travail

Une collection de sièges confortables, polyvalents et innovants. Leurs caractéristiques ergonomiques sont certifiées par de nombreuses normes internationales. Les multiples options fonctionnelles permettent de répondre à différents besoins, pour un poste de travail personnalisé.

designers

Massimo Costaglia
Giulio Mazzanti
R&D Milani

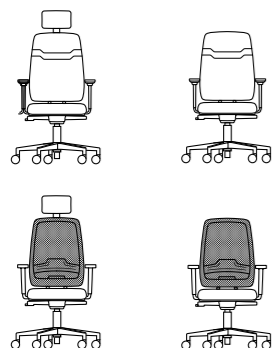

designer
Massimo Costaglia

it Sistema di sedute operative, ergonomiche e confortevoli, perfette per arredare anche gli ambienti direzionali. Sono disponibili nella versione con schienale in rete o imbottite, con appoggio lombare interno regolabile.

en A collection of ergonomic, comfortable office chairs, perfect even for the boardroom. Available in versions with mesh or padded backrest, with adjustable internal lumbar support.

fr Gamme de sièges de travail ergonomiques et confortables, parfaits pour aménager les bureaux de direction. Disponibles dans la version à dossier en résille ou rembourré, avec soutien lombaire réglable intégré.



finishes
SL 8517 + GO 0033



finishes
1. ER 0041 / 2. MI 1006



finishes

1. GO 0033 + NE 0411
2. ER 0041

it_Tam schienale imbottito,
caratteristiche tecniche.
en_Tam padded backrest,
technical characteristics.
fr_Tam dossier capitonné,
caractéristiques techniques.

it_Sedile e schienale
in schiumato ad alta densità.
en_High density injected
foam seat and backrest pad.
fr_Assise et dossier en
mousse injectée haute densité.



it_Supporto lombare
interno regolabile in altezza.
en_Height adjustable
inner lumbar support.
fr_Soutien lombaire interne
réglable en hauteur.

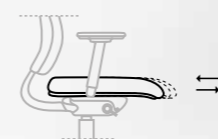

it_Traslatore di seduta.
en_Sliding seat.
fr_Translation d'assise.

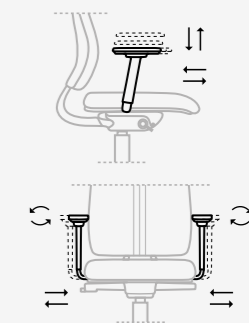
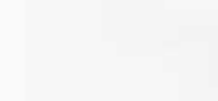

it_Scelta di braccioli
regolabili 1D, 2D e 4D.
en_Choice of 1D, 2D and
4D adjustable armrests.
fr_Choix d'accoudoirs
réglables 1D, 2D ou 4D.



it_Meccanismo sincronizzato
con cinque posizioni di blocco
e regolazione laterale.
en_Five locking positions
synchronized mechanism
with side tension control.
fr_Mécanisme synchrone
avec cinq positions de
blocage et régulation latérale.





finishes

ZS 0811 + GO 0033



loop

100

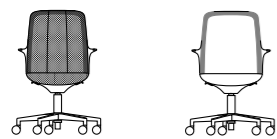

designer
Massimo Costaglia & Giulio Mazzanti

it Seduta meeting dal profilo nitido e armonico, sottile ed elegante. La struttura in plastica – rivestita in rete o in tessuto portante – e il meccanismo oscillante garantiscono livelli di comfort ottimali.

en Subtle, elegant meeting chairs with a clean, harmonious profile. The plastic structure – upholstered in mesh or in tensile fabric – and the tilt mechanism guarantees the highest levels of comfort.

fr Siège de réunion à la ligne essentielle et harmonieuse, fine et élégante. Sa structure en plastique, revêtue de résille ou de tissu autoportant, et le mécanisme basculant offrent un confort optimal.

101



operative – loop

finishes
1. KT 0060 / 2. KT 0080



finishes

1-2. KT 0090 / 3. KT 0060



finishes
1. KT 0060 / 2. KT 0090 / 3. KT 0080



finishes
KT 0021

it_Loop rete,
caratteristiche tecniche.
en_Loop mesh chair,
technical characteristics.
fr_Loop résille,
caractéristiques techniques.

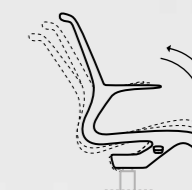

it_Meccanismo oscillante.
en_Tilting mechanism.
fr_Mécanisme basculant.

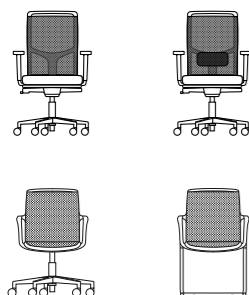

designer
R&D Milani

it_I diversi aspetti tecnici sono stati studiati per conferire maggiore ergonomia e solidità al modello. Lo schienale in rete, disponibile in otto colori, è indipendente e regolabile in altezza. Su richiesta viene inserito il supporto lombare. La versione visitatore viene presentata con slitta impilabile cromata, nera o bianca.

en_The various technical features of this model have been designed to offer the best possible strength and ergonomic performance. The mesh backrest can be a separate colour, with eight to choose from, and is height adjustable. Lumbar support can be included on request. The visitor version comes with a stackable chromed, black or white cantilever frame.

fr_Les différents aspects techniques ont été étudiés pour accroître la solidité et l'ergonomie de ce modèle. Le dossier en résille, disponible en huit coloris, est indépendant et réglable en hauteur. Le soutien lombaire peut être intégré sur demande. La version visiteur présente un piètement luge chromé, noir ou blanc.



finishes
MA 0304 + RT 0015

finishes

1. ML 0014 + RT 0024
2. NE 0533 + RT 0024

it_Zed operativa,
caratteristiche tecniche.
en_Zed operative,
technical characteristics.
fr_Siège de travail Zed,
caractéristiques techniques.



it_Schienale regolabile in altezza.
en_Height-adjustable backrest.
fr_Dossier réglable en hauteur.



it_Supporto lombare
regolabile in profondità.
en_Depth-adjustable
lumbar support.
fr_Soutien lombaire
réglable en profondeur.



it_Traslatore di seduta.
en_Sliding seat.
fr_Translation d'assise.

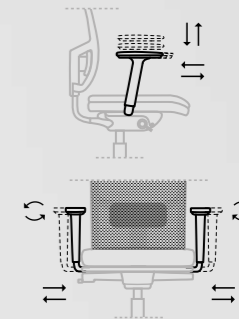

it_Scelta di braccioli
regolabili 1D, 2D e 4D.
en_Choice of 1D, 2D and
4D adjustable armrests.
fr_Choix d'accoudoirs
réglables 1D, 2D ou 4D.



it_Sedile in schiumato
ad alta densità.
en_High density
injected foam seat pad.
fr_Assise en mousse
injectée haute densité.



it_Meccanismo sincronizzato
con cinque posizioni di blocco
e regolazione laterale.
en_Five locking positions
synchronized mechanism
with side tension control.
fr_Mécanisme synchrone
avec cinq positions de
blocage et régulation latérale.



finishes
1. ZS 02E8 + RT 0024 / 2. Kvadrat
Remix 3 MX 0133 + RT 0021



finishes
 1-3. Kvadrat Remix 3 MX 0133 + RT
 0024 / 4. SL 8532 + RT 0015



finishes

1. RC 8030 + RT 0024
 2. RC 3504 + RT 0014
-



finishes

3. SL 3030 + RT 0014
 4. RC 8030 + RT 0015
-



designer
R&D Milani

it Five è una poltroncina operativa con meccanismo sincronizzato. Con schienale alto e braccioli regolabili in altezza, la base può essere in nylon o in alluminio lucido.

en Five is an office chair with synchronized mechanism. It has a high back and height-adjustable arms, while the base comes in nylon or in polished aluminium.

fr Five est un fauteuil de travail à mécanisme synchrone. Muni d'un dossier haut et d'accoudoirs réglables en hauteur, son piétement est disponible en nylon ou en aluminium poli.



finishes
1. SL 3509 / 2. SL 1506

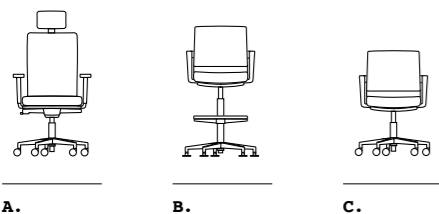

A.

B.

C.

designer
R&D Milani

it Famiglia di sedute operative e funzionali. Sono disponibili in molteplici varianti e in un'ampia gamma di combinazioni: con scocca e braccioli in plastica bianca o nera, schienale imbottito o in rete e poggiatesta regolabile rivestito. Le basi possono essere in alluminio o in nylon nero.

en A family of functional office chairs. Available in various options and in a wide range of combinations: with body and arms in white or black plastic, padded or mesh backrest and adjustable padded headrest. The bases come in aluminium or nylon.

fr Une gamme de sièges de travail fonctionnels. Disponibles dans de nombreuses variantes et dans une vaste gamme de combinaisons: avec structure et accoudoirs en plastique blanc ou noir, dossier rembourré ou en résille et appuie-tête réglable revêtu. Les bases peuvent être en aluminium ou en nylon noir.



finishes
RC 8030 + GO 0033



finishes
1. NE 0015 + GO 0089 / 2. NE 0573
+ GO 0089 / 3. NE 0533 / 4. NE 0333



finishes

1. RC 8502 + GO 0033
2. LN 2523 + GO 0001

it_Lex operativa rete,
caratteristiche tecniche.
en_Lex operative mesh,
technical characteristics.
fr_Lex opérative maille,
caractéristiques techniques.

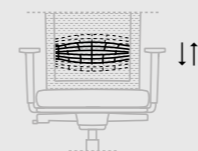

it_Poggiatesta regolabile
in altezza e orientamento.
en_Height and orientation
adjustable padded headrest.
fr_Appui-tête réglable en
hauteur et orientable.



it_Supporto lombare
regolabile in altezza.
en_Height adjustable
lumbar support.
fr_Soutien lombaire
réglable en hauteur.

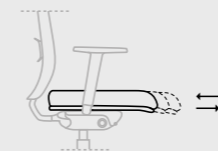

it_Traslatore di seduta.
en_Sliding seat.
fr_Translation d'assise.

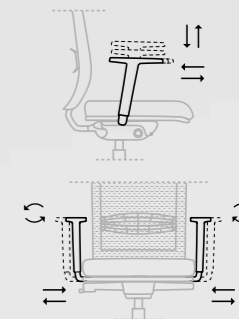

it_Scelta di braccioli
regolabili 1D, 2D e 4D.
en_Choice of 1D, 2D and
4D adjustable armrests.
fr_Choix d'accoudoirs
réglables 1D, 2D ou 4D.

it_Sedile in schiumato
ad alta densità.
en_High density
injected foam seat pad.
fr_Assise en mousse
injectée haute densité.

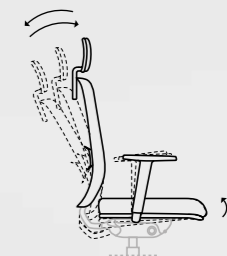

it_Meccanismo sincronizzato
con cinque posizioni di
blocco e regolazione laterale.
en_Five locking positions
synchronized mechanism
with side tension control.
fr_Mécanisme synchrone
avec cinq positions de
blocage et régulation latérale.



finishes

- 1. NE 0018
 - 2. ZS 01B4 + GO 0043
-

finishes

- 3. SL 3030 / 4. NE 0572 + GO 0001
-



finishes
1. RC 6501 / 2. RC 6508 / 3-4. RC 7504



finishes

1. SL 8517 + GO 0033
 2. RC 7504
-



finishes

3. RC 7504 / 4. NE 0411 + GO 0001 /
 5. RC 3508
-



contract



nordic
p. 136



people
p. 144



people home
p. 156



people work
p. 164



nuvola
p. 170



beth
p. 180



quiet
p. 190



bakku
p. 200



shock
p. 208



nesis
p. 214



nesis chic
p. 218



cocktail
p. 222



daisy
p. 226



only
p. 230



mi chair
p. 234



mirò
p. 246



ellipse
p. 256



lillie
p. 260



adalia
p. 264



terre
p. 268



fungus
p. 272



plot
p. 276

divani e sedute attesa

In equilibrio tra design e comfort, le poltroncine e i divani sono ideati per sale d'attesa, bar, ristoranti e hotel. Dalla scelta dei materiali al disegno delle forme, morbide e avvolgenti, ogni modello è studiato con cura e nel dettaglio, in linea con il concetto di break out area, spazio che oggi riveste una grande importanza nel mondo dell'ufficio.

waiting area sofas and seating

Bringing together design and comfort, our armchairs and sofas are designed for waiting rooms, bars, restaurants and hotels. From the choice of materials to the soft, welcoming shapes, each model is designed with care and attention to convey the concept of a break out area, a space of great importance in today's offices.

canapés et fauteuils

Dans un équilibre entre design et confort, les fauteuils et canapés proposés sont pensés pour les salles d'attente, les cafés, les restaurants et les hôtels. Du choix des matériaux au design des formes, douces et enveloppantes, chaque modèle est étudié dans le moindre détail, en ligne avec l'idée d'espace de détente qui prend de plus en plus de place dans l'entreprise.

designers

Baldanzi & Novelli
C/B Design
Alessandro Crosera
Orlandini Design
Giovanni Ingignoli
R&D Milani
Margherita Rui

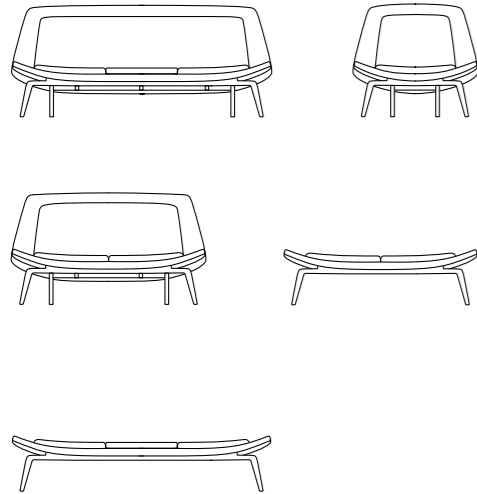

designer
Baldanzi & Novelli

it Collezione di poltroncine, divani e panche dalle linee flessuose dedicate all'attesa. Il telaio in legno e lo schienale con imbottitura doppia, realizzabile in un'ampia gamma di tessuti, conferiscono ai modelli un aspetto evocativo e contemporaneo. La cucitura può essere a doppia ribattitura o a croce.

en A collection of armchairs, sofas and benches with soft lines for a comfortable wait. The wooden frame and the double-padded backrest, available in a wide range of fabrics, give these models an appealing, contemporary look. Choose from a double-stitched or cross-stitched finish.

fr Collection de fauteuils, de canapés et de banquettes aux lignes ondulantes conçues pour les salles d'attente. Le châssis en bois et le dossier à double rembourrage, disponible dans une vaste gamme de tissus, confèrent aux modèles un aspect contemporain et très esthétique. La couture peut être croisée ou à double surpiqûre.

sizes and modules p. 329



finishes
1. FE 0301 / 2. RC 6501



finishes
1, 3. Kvadrat Remix 3 MX 0612 /
2. Kvadrat Remix 3 MX 0632



finishes

1. Kvadrat Remix 3 MX 0753
 2. FE 0301
-



finishes

1. RC 8030
 2. Kvadrat Remix 3 MX 0612
-



people

144

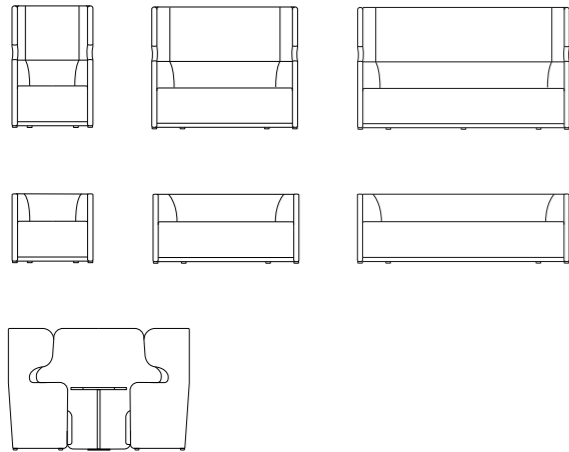

designer
Alessandro Crosera

it_Forme fluide e versatili caratterizzano i divani e le poltrone People, proposti con schienale basso o alto. Nella versione privacy con scrivania creano aree di attesa e postazioni di incontro, garantendo l'isolamento necessario in ambienti open space. Possono essere dotati di presa elettrica e USB, e/o tasca laterale portariviste e portamonitor.

en_Fluid, versatile shapes distinguish People sofas and armchairs, available with low or high backrest. The pod version with its individual desk is perfect for waiting areas and meeting areas, guaranteeing the privacy required for open-plan environments. These sofas can be equipped with power and USB sockets, and/or a side magazine pocket and screen bracket.

fr_Les canapés et fauteuils People, à dossier haut ou bas, sont caractérisés par des formes fluides et polyvalentes. Dans la version à cellule, ils sont parfaits pour les zones d'attente et de rencontre, donnant l'intimité nécessaire dans un open space. Ils peuvent être équipés de prise électrique et USB et/ou de poches de rangement latérales et porte écran.

sizes and modules p. 330

145

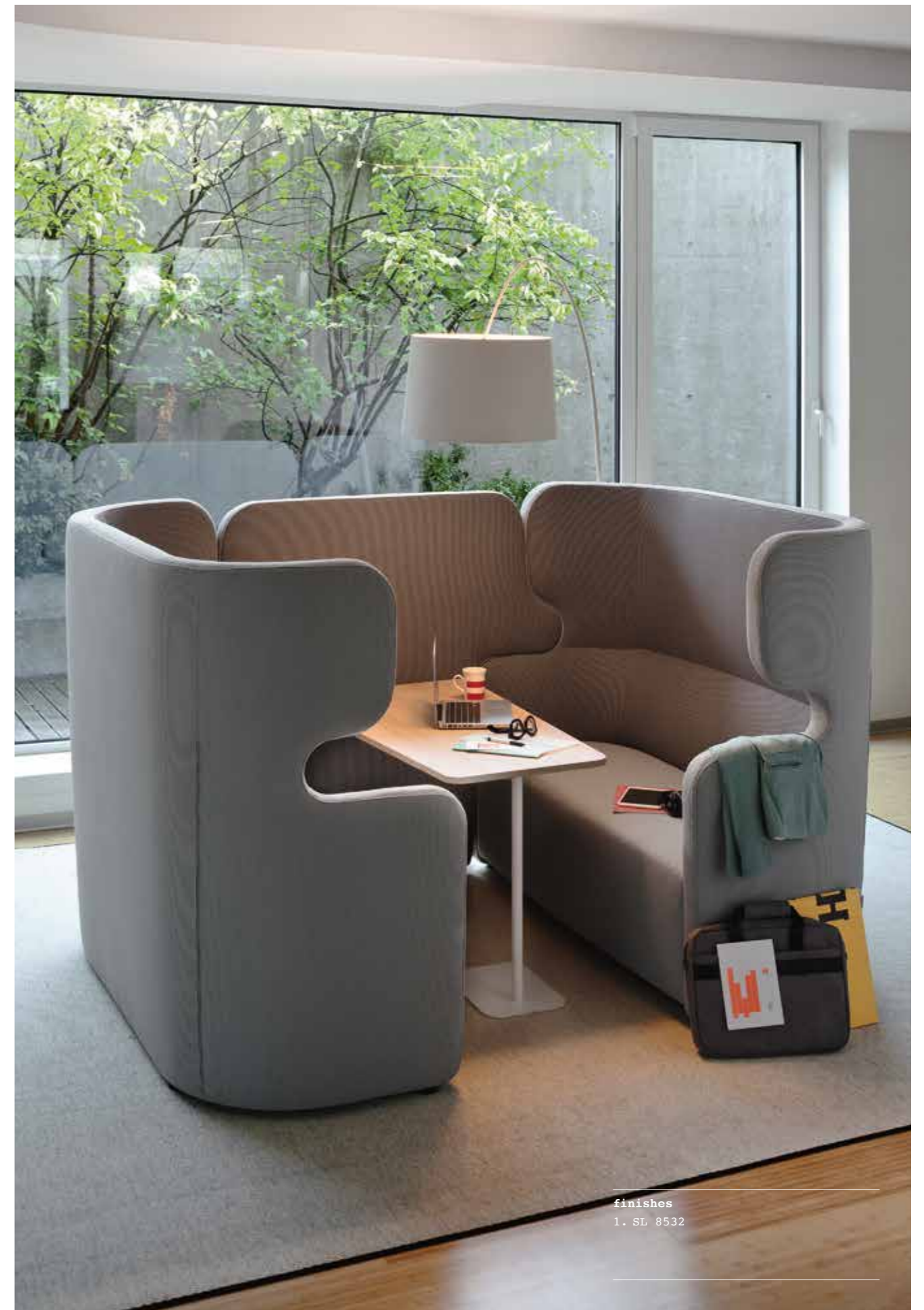

finishes
1. SL 8532



finishes
1-2. FE 0512 + FE 0453

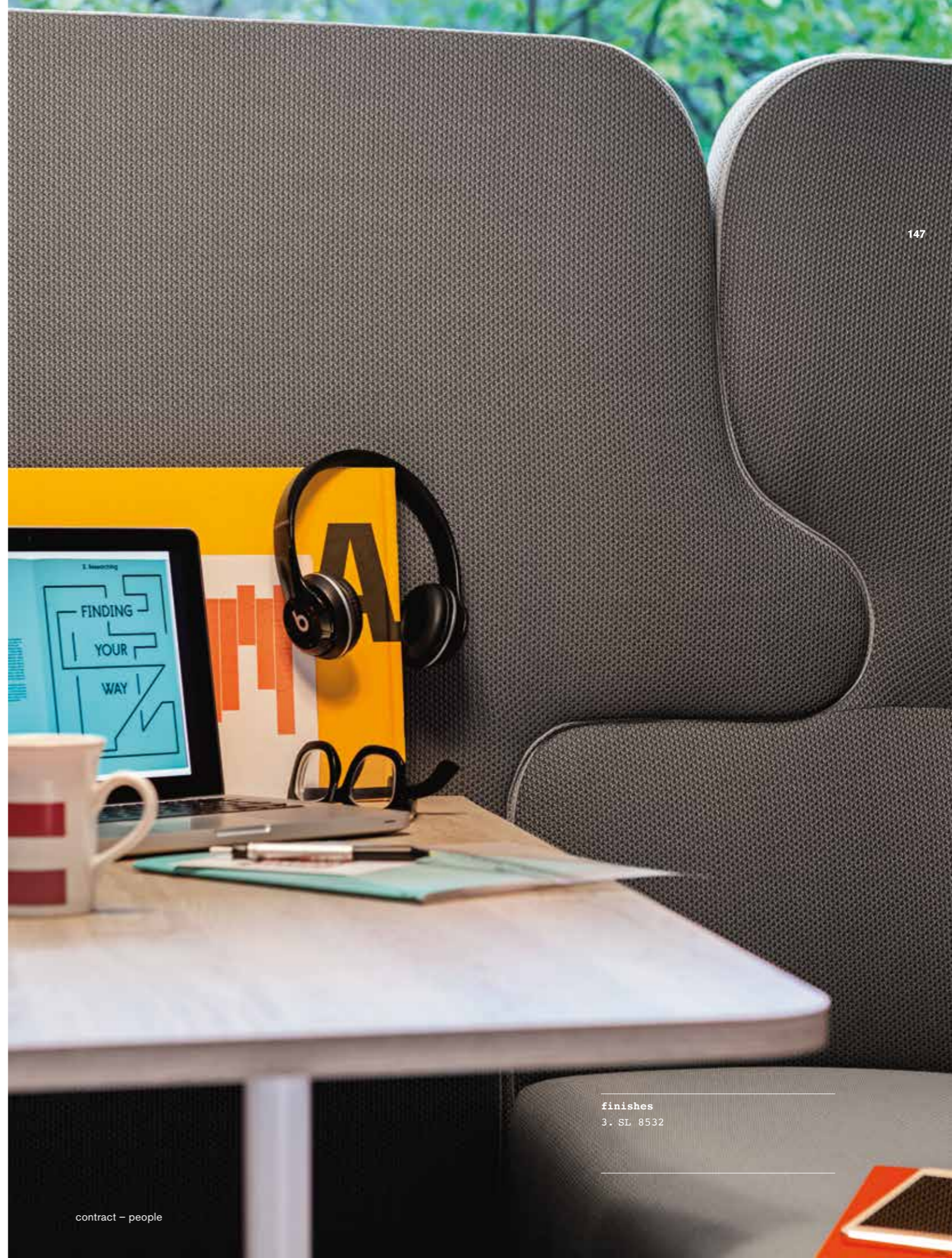

finishes
3. SL 8532





finishes

1-4. Kvadrat Rime 0721 + Kvadrat
Remix 3 MX 0762 / 5. Kvadrat Rime
0541 + Kvadrat Remix 3 MX 0632

it_Presa elettrica e USB.
en_Electrical and USB socket.
fr_Prise électrique et USB.



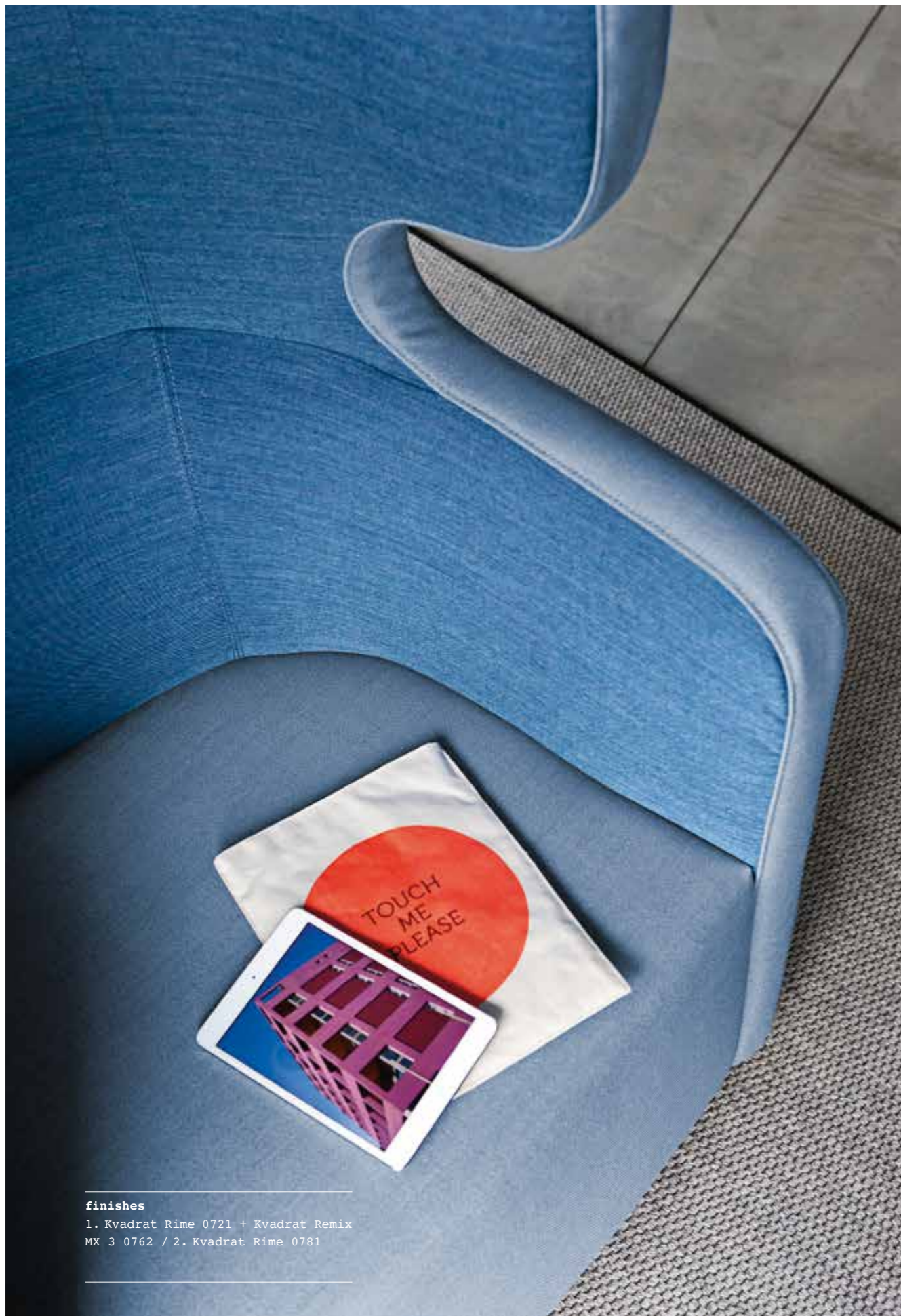

finishes
 1. Kvadrat Rime 0721 + Kvadrat Remix
 MX 3 0762 / 2. Kvadrat Rime 0781



it_Tasca portariviste.
 en_Magazine side pocket.
 fr_Poche porte-magazines.



finishes
FE 0505 + FE 0453

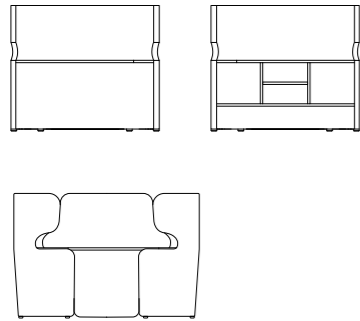

designer
Alessandro Crosera

it Questa versione People è l'evoluzione del pod People a cui abbiamo aggiunto uno schienale più alto e un tetto, per un isolamento ancora maggiore. Viene fornito con pannello medio o alto e con illuminazione e prese già incluse.

en This People version is the evolution of the People pod where we have added a higher backrest and a rooftop, for even higher isolation. Comes with medium or high panel and delivered with lighting and sockets included.

fr Cette version People est l'évolution de la cellule People où nous avons ajouté un dossier plus haut et un toit, pour une isolation encore plus élevée. Disponible avec panneau moyen ou haut et livré avec éclairage et prises incluses.

sizes and modules p. 330



finishes
1. ML 0007 + ML 0020



finishes
FE 0301 + FE 0621





finishes
1. ML 0007 + ML 0020



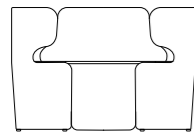
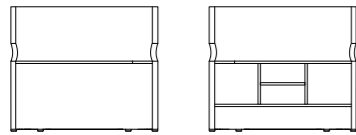

designer
Alessandro Crosera

it People Work è un'ulteriore nuova evoluzione della gamma People. Si trasforma in una vera e propria postazione da lavoro con piani, mensole e prese per uno spazio lavorativo autonomo e protetto.

en People Work is a further new evolution of the People range. It transforms into a real workstation with desk, shelves and sockets for an autonomous and protected working space.

fr People Work est une autre nouvelle évolution de la gamme People. Il se transforme en véritable poste de travail avec bureau, étagères et prises pour un espace de travail autonome et protégé.

sizes and modules p. 330



finishes
FE 0602 + FE 0601



finishes
ML 0025 + ML 0010



finishes
FE 0602 + FE 0601



nuvola

170

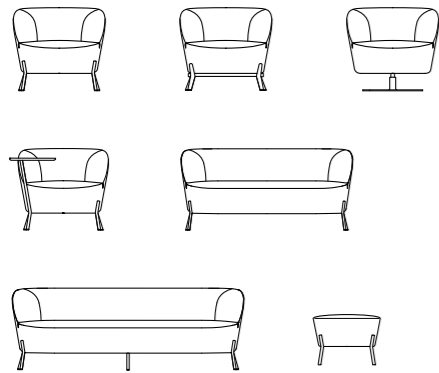

designer
C/B Design

it_Nuvola è un morbido monolite che trasmette una sensazione di calore e benessere all'ambiente in cui viene inserito. I diversi modelli sono disponibili con gambe cromate, in legno o con colonna girevole. Alla struttura può inoltre essere applicato un tavolino orientabile.

en_Nuvola is a soft monolite that transmits a sense of warmth and wellbeing to any setting. The different models are available with chrome or wooden legs or swivel column base. A small adjustable table can be incorporated into the structure.

fr_Nuvola est un fauteuil monobloc qui transmet une sensation de chaleur et de bien-être à l'environnement dans lequel il est intégré. Les différents modèles sont disponibles en version à pieds chromés ou bois, ou à pied pivotant. Une petite table orientable peut être intégrée à la structure.

sizes and modules p. 329

171

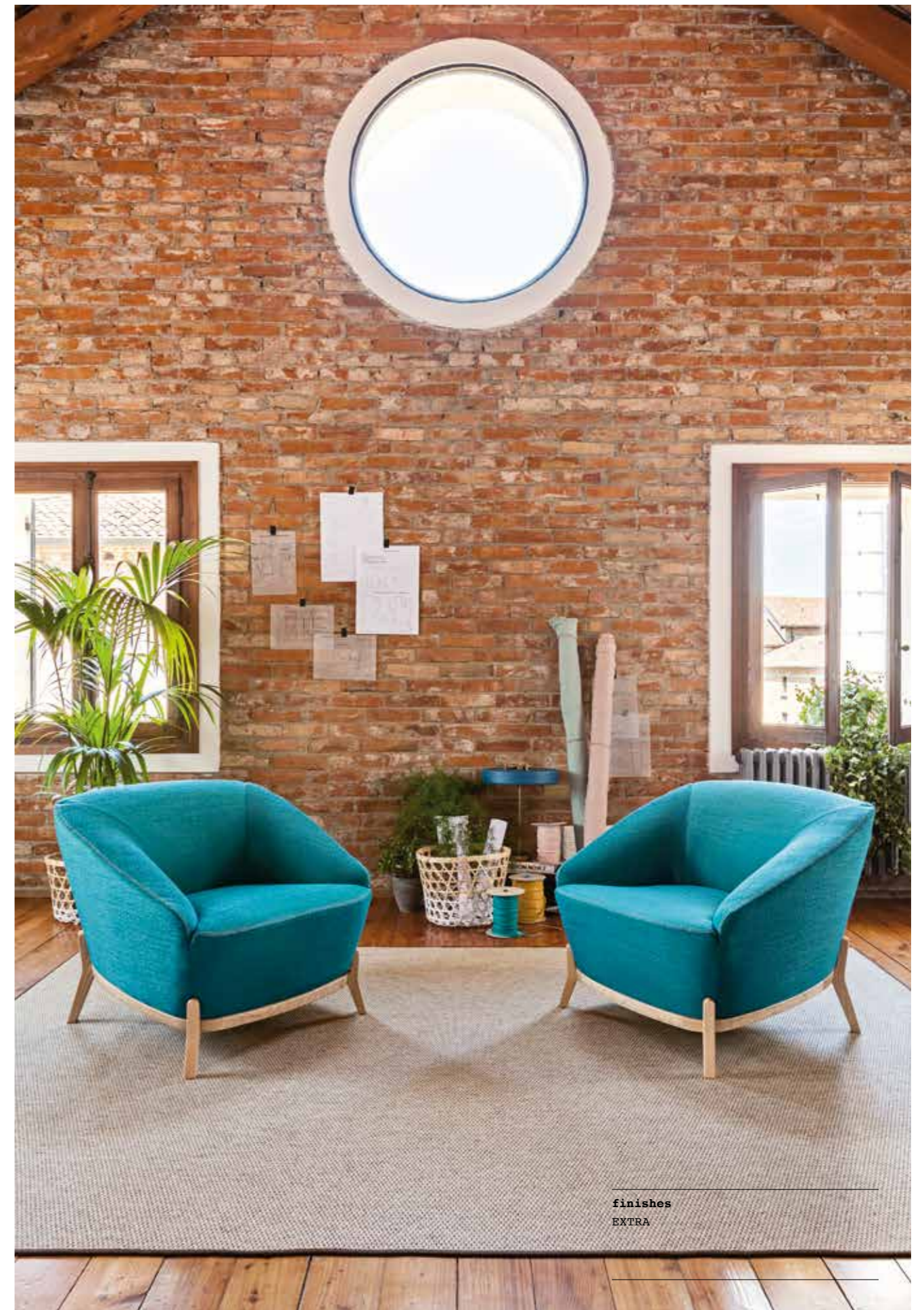

finishes
EXTRA



finishes

1. RC 6501



finishes

2. LN 2335 / 3. Kvadrat Rime 0911



finishes

1. Kvadrat Remix 3 MX 0133
 2. Kvadrat Remix 3 MX 0753
-

it_Optionale: cucitura a pettine.
 en_Optional: blanket stitch detailing.
 fr_En option : couture point de feston.

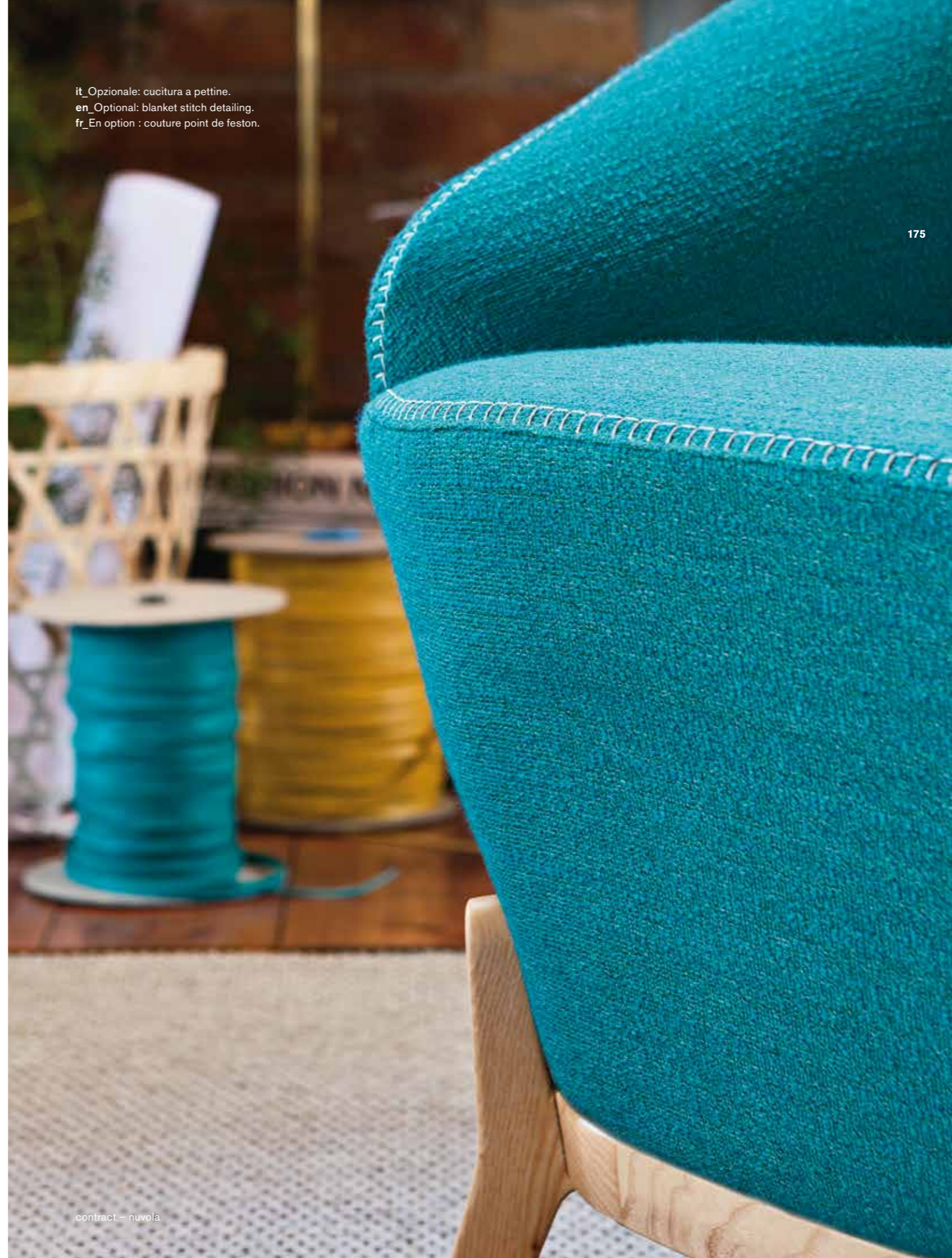

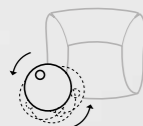

it_Tavolino scrittoio girevole.
 en_Pivoting coffee table.
 fr_Tablette pivotante.



finishes
 1. ML 0002



finishes
 2-3. ML 0022



finishes
 1. RC 6501 / 2. ML 0022

beth

180

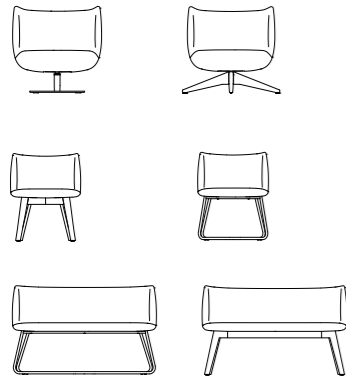

designer

Alessandro Crosera & Elena Pistolato

it_Serie contract di poltroncina, divanetto e lounge dalle dimensioni generose e con forme rotondeggianti. La versione poltroncina e divanetto a due posti viene proposta con una caratteristica base in metallo o con base a quattro gambe in legno mentre la versione lounge, ideale per aree relax e alberghi, viene proposta in versione con colonna girevole o con base piramidale girevole in legno.

en_Soft seating series of armchair, sofa and lounge chair with generous dimensions and rounded shapes.

The armchair and two-seater sofa series is proposed with a characteristic metal base or with a four-legged wooden base, while the lounge version, ideal for breakout areas and hotels, is proposed with pivoting metal base or with pivoting pyramidal wooden base.

fr_Série contract de fauteuil, canapé et lounge aux dimensions généreuses et aux formes arrondies. La version fauteuil et canapé à deux places est proposée avec une caractéristique base en métal ou avec un piètement en bois quatre pieds tandis que la version lounge, idéale pour les espaces détente et les hôtels, est proposée avec colonne pivotante en métal ou avec une base pyramidale pivotante en bois.

sizes and modules p. 328

181



finishes

1. LN 0632 / 2. ERA 0023





finishes
1. ML 0036
2-3. FE 0453

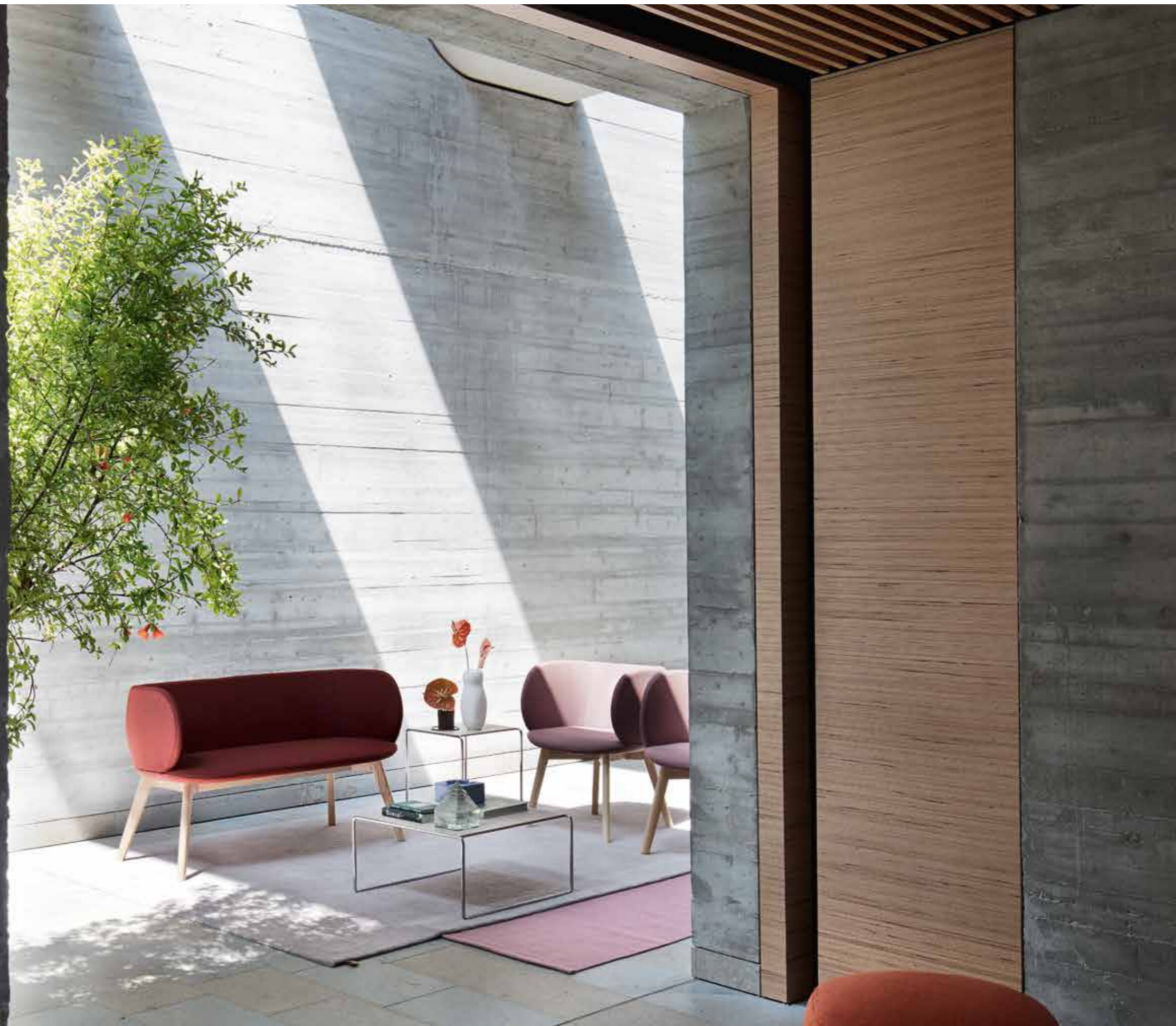

finishes

- 1. Kvadrat Rime RI 0591
 - 2-3. Kvadrat Rime RI 0731
-



finishes
EXTRA

quiet

190

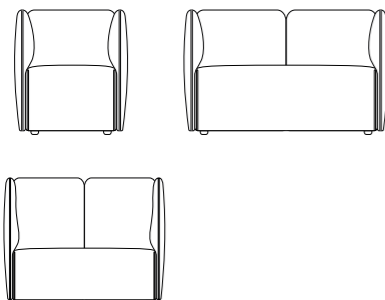

designer

Alessandro Crosera & Elena Pistolato

it_Serie di moduli componibili caratterizzati da schienali e braccioli double face e da una doppia altezza schienale, per creare composizioni più o meno separate tra loro. L'alto numero di forme disponibili permette di ideare isole e composizioni uniche e dal segno marcato grazie alle linee geometriche del prodotto.

en Series of composable modules characterized by double-sided backrests and armrests and a double-height backrest, to create more or less separate compositions. The large number of available shapes allows the creation of islands and unique compositions with a marked sign thanks to the geometric lines of the product.

fr_Série de modules componibles caractérisés par des dossiers et accoudoirs à double face et le dossier à double hauteur, pour créer des compositions plus ou moins séparées. Le grand nombre de formes disponibles permet la création d'îlots et de compositions uniques avec un signe marqué grâce aux lignes géométriques du produit.

sizes and modules p. 330

191

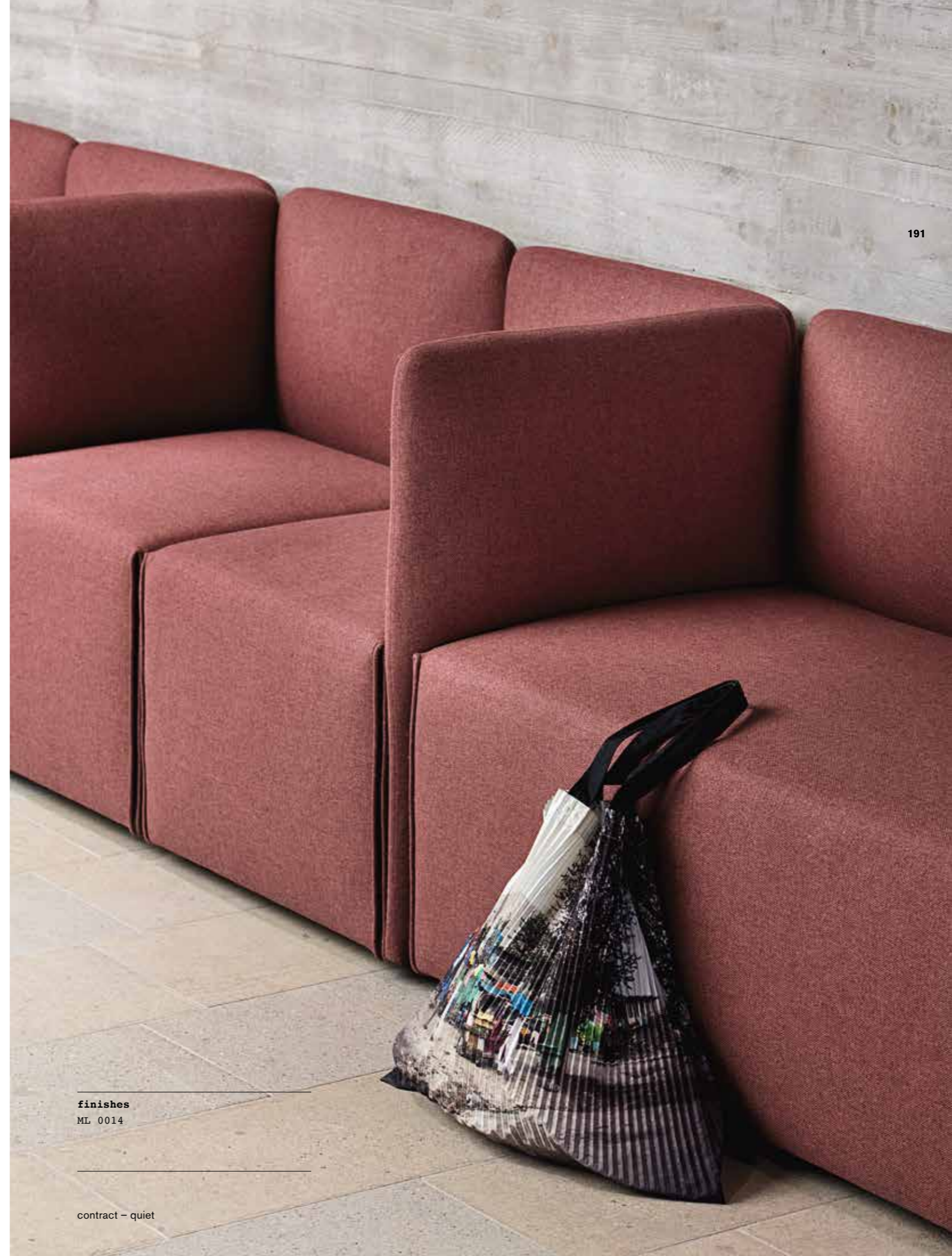

finishes

ML 0014

contract - quiet



finishes
1. RC 8501 + RC 7504



finishes
FE 0301





finishes
RC 8501 + RC 7504



finishes
FE 0052



finishes
1. FE 0301
2-3. FE 0052

bakku

200

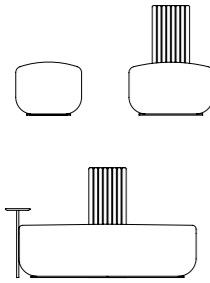

designer

Margherita Rui

it_Bakku è una collezione di quattro pouf che permette di realizzare isole di relax all'interno degli spazi contract. Modulari, i pouf si accostano tra loro in composizioni dinamiche e spensierate, impreziosite da due pratici accessori: uno schienale morbido, ma dal profilo deciso, e un tavolino tondo, in laminato, posizionabile ai lati delle sedute.

en_Bakku is a collection of four ottomans that allows to create relax islands within community spaces. Modifiable, the poufs are combined with each other in dynamic and free compositions, embellished with two practical accessories: a soft but with a strong profile backrest, and a round laminate table, which can be positioned on the sides of the seats.

fr_Bakku est une collection de quatre poufs qui permet de créer des lots de détente au sein d'espaces contract. Modulables, les poufs se combinent entre eux dans des compositions dynamiques et insouciantes, agrémentés de deux accessoires pratiques: un dossier moelleux mais avec un profil solide, et une table ronde, en stratifié, qui peut être positionnée sur les côtés des sièges.

sizes and modules p. 328

201

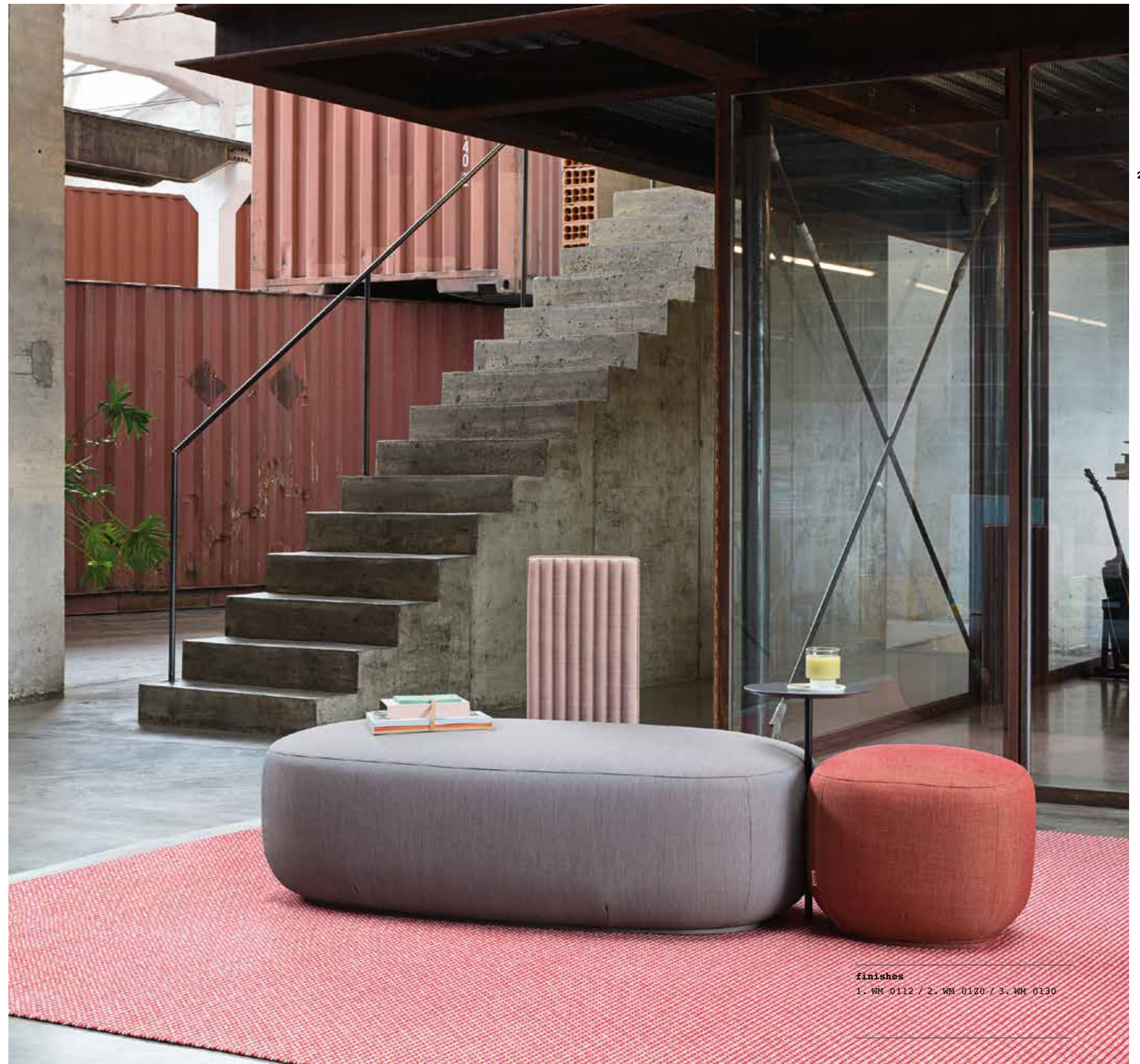

finishes

1. WM 0112 / 2. WM 0120 / 3. WM 0130



finishes

1. ML 0007 / 2. ML 0021 / 3. ML 0002
/ 4. ML 0013



finishes

5. Kvadrat Remix 3 MX 0722
6. Kvadrat Remix 3 MX 0632



finishes

1. Kvadrat Rime RI 0721 / 2-3,7.
Kvadrat Rime RI 0911 / 4. Kvadrat
Rime RI 0111

finishes

5-6. Kvadrat Rime 0731
8-10. Kvadrat Rime RI 0781



finishes

1. FE 0601 / 2-4. Kvadrat Rime RI
0781 / 5. Kvadrat Rime RI 0911



finishes

6. Kvadrat Remix 3 MX 0612 / 7. ML
0007 / 8. ML 0002

shock

208

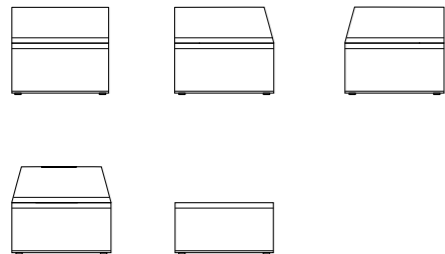

designer
Alessandro Crosera

it_Shock è un sistema modulare di sedute che può essere configurato come composizione articolata costituita da più elementi o come divano singolo, dove i braccioli ne definiscono i confini. Le paretine divisorie in opzione creano spazi di privacy confortevoli dando allo stesso tempo ancor maggiore carattere alle composizioni.

en_Shock is a modular seating system that can be configured as a combination of elements or as a single sofa, whose limits are defined by where the arms are placed. The optional division panels create comfortable private spaces while providing an even higher character to the composition at the same time.

fr_Shock est un système d'assises modulable: il peut être composé de plusieurs éléments, ou d'un seul canapé, les limites étant posées par les accoudoirs. Les panneaux divisoirs en options créent espaces privés confortables et donnent au même temps un majeur caractère à la composition.

sizes and modules p. 331

209



finishes
RC 6501



finishes
1. ML 0022 / 2. ML 0036 + ML 0034

finishes
3. ZS 01B4 + ZS 08I1

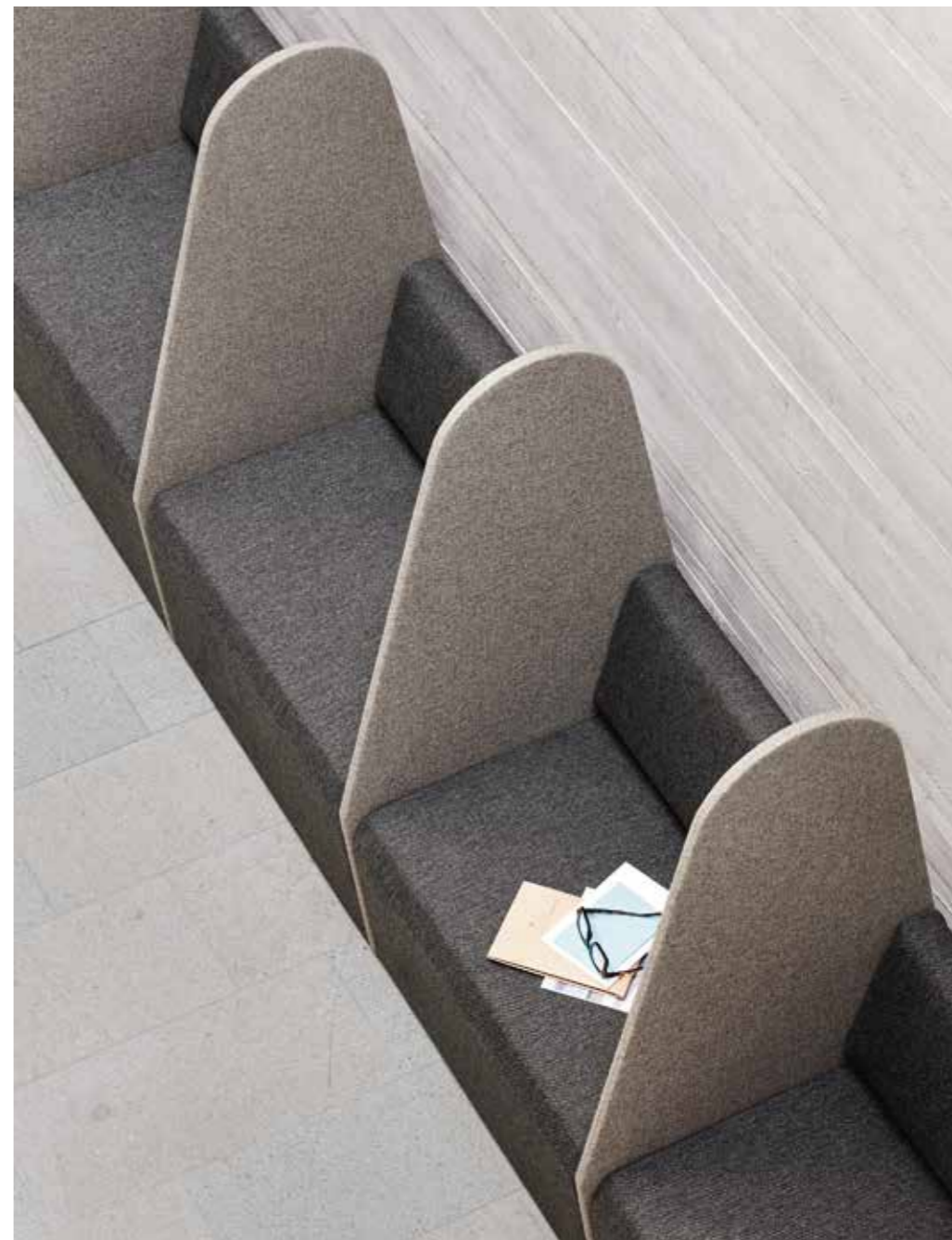

finishes
ML 0016 + ML 0002

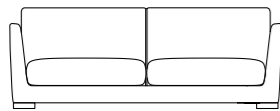
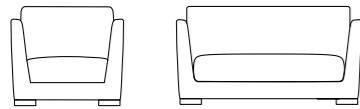

designer
Alessandro Crosera

it Poltrona e divano classici dalle forme piene, a due e tre posti, disegnati sia per l'ambito contract che per quello privato. I piedini possono essere tondi o quadrati in acciaio cromato. Il sedile e lo schienale sono rimovibili.
en A classic fuller-form armchair and sofa, available in two- or three-seat versions, perfect for contract settings or private homes. The chromed steel feet can be round or square. The seat and the backrest are removable.
fr Fauteuil et canapé classiques aux formes pleines, à deux ou trois places, conçus aussi bien pour l'espace de détente au travail que pour le domicile. Pieds arrondis ou carrés en acier chromé. L'assise et le dossier sont amovibles.

sizes and modules p. 329



finishes
ML 0024



finishes

1. FE 0201 / 2. FE 0601 / 3. ML 0024



nesis chic

218

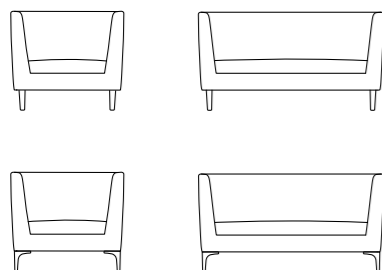

designer
Alessandro Crosera

it Poltrona e divano a due posti, elegantemente rifiniti, pensati per le sale d'attesa e gli hotel. L'ampia gamma di tessuti, pelli e colori e la possibilità di scegliere tra piedini in metallo cromato o in legno verniciato, consentono infinite combinazioni e personalizzazioni. Il sedile è rimovibile.
en A refined, elegant armchair and two-seat sofa, designed for waiting rooms and hotels. The wide range of fabrics, leathers and colours and the possibility to choose between chromed metal or varnished wood feet allow infinite combinations and a high degree of personalisation. The seat is removable.
fr Fauteuil et canapé deux places, à finition élégante, pensé pour les salles d'attente et les hôtels. La vaste gamme de tissus, de cuirs et de coloris disponibles et la possibilité de choisir entre des pieds en métal chromé ou en bois verni permettent une personnalisation et des combinaisons infinies. L'assise est amovible.

sizes and modules p. 329

219



finishes
RC 3508



finishes

1. EXTRA / 2. FE 0301 / 3. RC 6508

cocktail

222

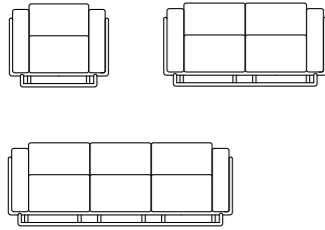

designer
Alessandro Crosera

it Ampi volumi geometrici definiscono la poltrona e il divano, a due e tre posti. I cuscini amovibili sono trattenuti da una struttura tubolare metallica, proposta anche in finitura cromata, verniciata bianca o antracite.
en Large geometric shapes define this armchair and two- and three-seat sofa. The detachable cushions are held in place by a tubular metal frame, also available in chrome, white-painted or anthracite finishes.

fr Les fauteuils et le canapé à deux ou trois places affichent des volumes géométriques. Les coussins amovibles sont maintenus par une structure tubulaire métallique, également disponible en finition chromée, vernie blanche ou anthracite.

sizes and modules p. 328

223



finishes
1. ER 0041 / 2. SL 3509

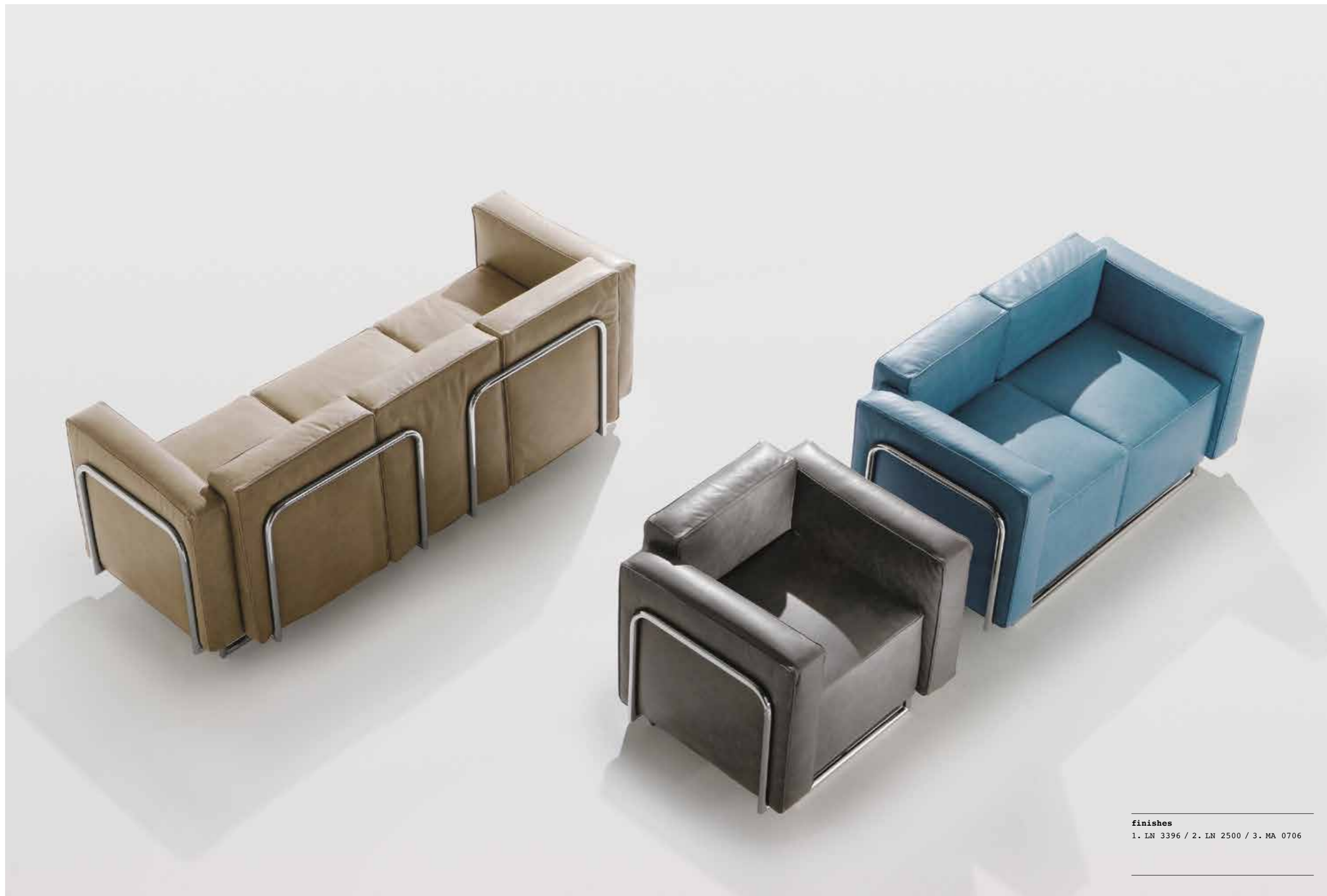

finishes
1. LN 3396 / 2. LN 2500 / 3. MA 0706

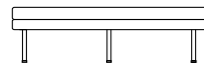
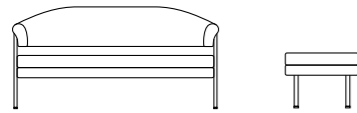
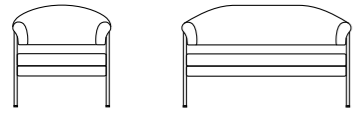

designer
R&D Milani

it Seduta accogliente e invitante, con sedile imbottito e rivestito in finitura capitonné. Disponibile nella versione poltrona singola, divano a due posti o maggiorato, panca. Le gambe sono in metallo cromato.

en A welcoming, inviting chair with a padded seat covered in buttoned fabric. Available as a single armchair, a sofa with two or more seats and as a bench. The legs are in chromed metal.

fr Un siège accueillant à assise rembourrée et revêtement capitonné. Disponible dans la version fauteuil simple, canapé deux places ou plus, et banquette. Les pieds sont en métal chromé.

sizes and modules p. 328



finishes
1, 3. Rubelli Cortez CZ 0013
2. LN 6644



finishes
1. LN 3364 / 2. LX 0018 / 3. LN 3396

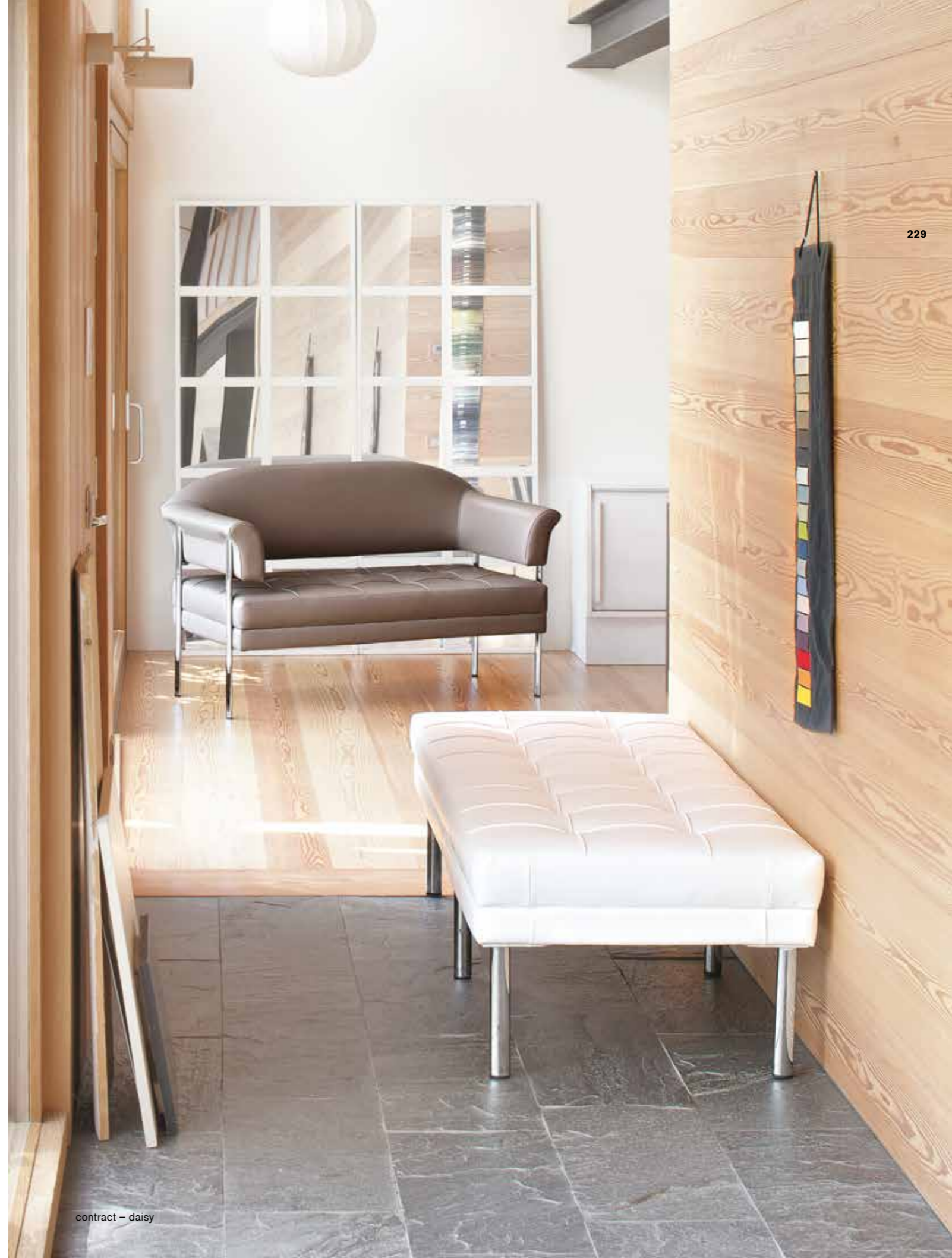

only

230

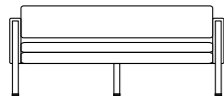
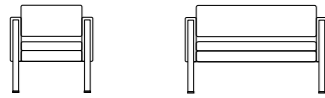

designer
R&D Milani

it_Famiglia di sedute dal design rigoroso. Struttura in legno, inserti bracciolo e gambe in metallo cromato o antracite. Disponibile in versione poltrona, o divano a due o tre posti.
en_A family of seats with a striking design. Built of wood with arm inserts and legs in a chrome or anthracite metal finish. Available as an armchair or as a two- or three-seater sofa.
fr_Ces sieges affichent un design rigoureux. Ils possèdent une structure en bois, et les accoudoirs et les pieds sont en métal chromé ou anthracite. Disponibles en version fauteuil ou canapé deux ou trois places.

sizes and modules p. 329

231



finishes
1. ZS 06M7 / 2. MA 0402

contract - only



finishes
ER 0040

mi chair

234

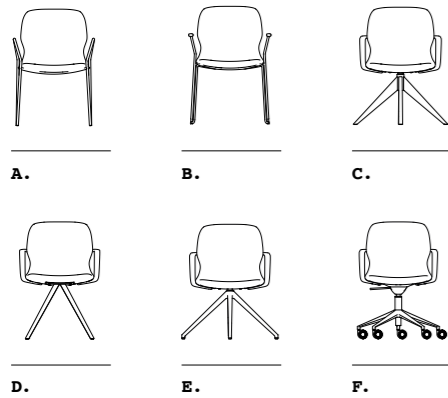

designer
Giovanni Ingnoli

it_Stile inconfondibile ed elegante nonché un confort straordinario per questa poltroncina che si caratterizza per il sinuoso bracciolo in alluminio che abbraccia la seduta. Progettata per potersi adattare, con le sue numerosi basi, a qualsiasi esigenza d'uso e ambiente. Viene proposta oltre che in finitura alluminio e nero, anche con colori di struttura iconici quali bronzo, rame e oro.

en_Unmistakable and elegant style as well as extraordinary comfort for this armchair which is characterized by the sinuous armrest that embraces the seat. Designed to be able to adapt, with its numerous bases, to any use and environment requirement. Other than polished aluminium or black frame, It is offered with iconic structure colors such as bronze, copper and gold.

fr_Un style unique et élégant ainsi qu'un confort extraordinaire pour ce fauteuil qui se caractérise par l'accoudoir sinueux en aluminium qui embrasse l'assise. Conçu pour pouvoir s'adapter, avec ses nombreuses bases, à toute exigence d'utilisation et d'environnement. A part l'aluminium poli et noir, la structure est également proposée avec des couleurs emblématiques telles que le bronze, le cuivre et l'or.

235



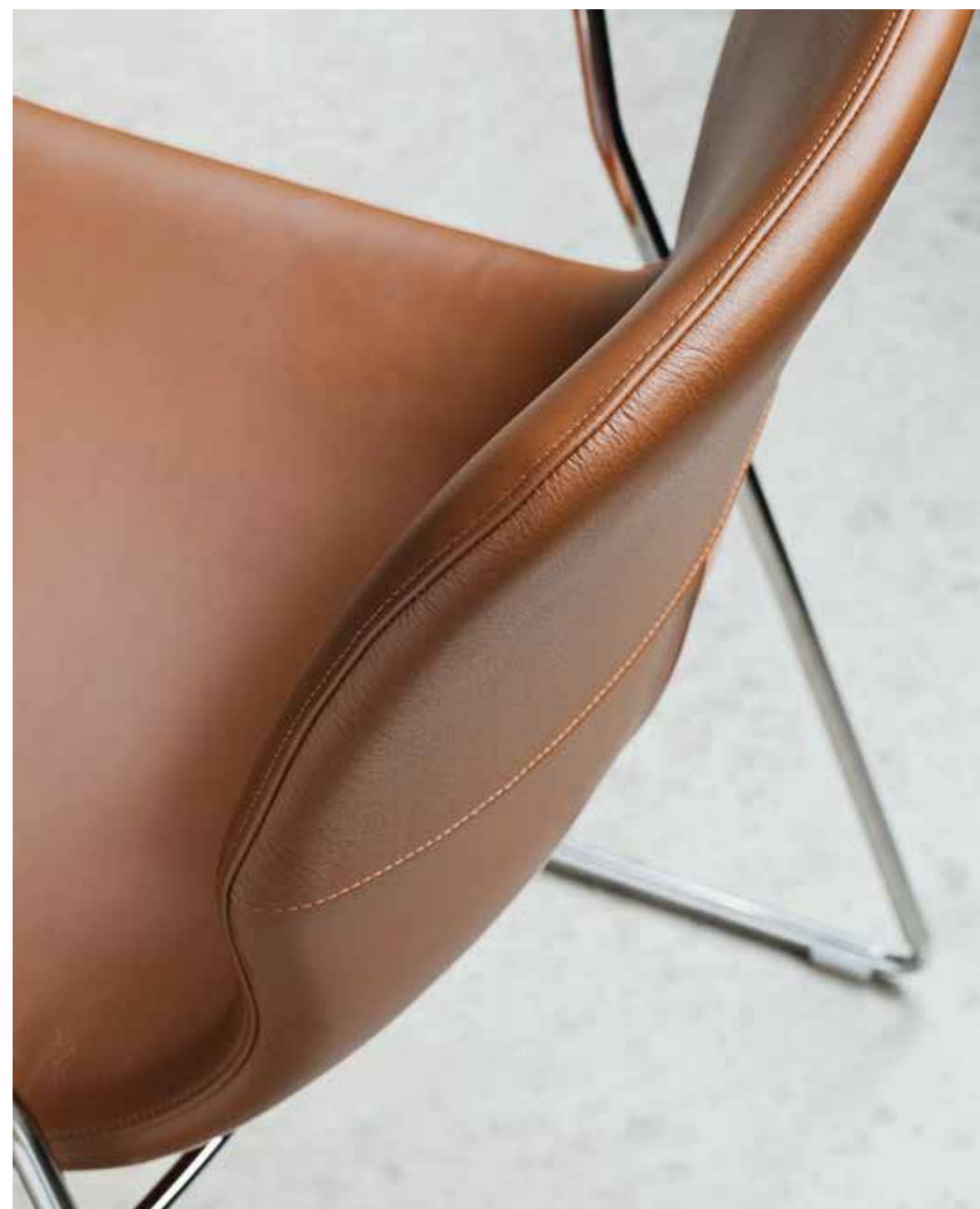

finishes
1-3. LN 5478



finishes

1. IR 0402 / 2. IR 0308



finishes

3. IR 0802 / 4. IR 0307



finishes

1. Rubelli Cortez CZ 0004 /
 2. Rubelli Cortez CZ 0016 /
 3. ML 0020
-





finishes

1. CL 0609 / 2. Kvadrat Rime RI 0911
/ 3. SL 1506 / 4. FE 0301





finishes
 1-2. RC 8030 / 3. Rubelli Cortez
 CZ 0020

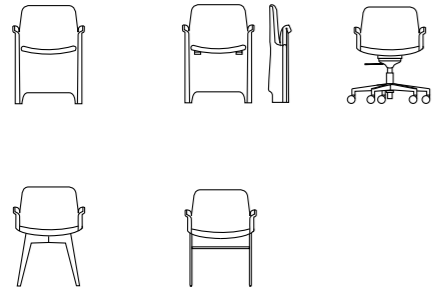

designer
Orlandini Design

it Un segno dinamico e un profilo sottile caratterizzano la poltroncina in schiumato. Lo schienale flessibile dona maggiore comfort alla seduta. È possibile scegliere tra numerosi modelli di basi, nella versione con sedile ribaltabile ha un ingombro contenuto.

en A striking design and a subtle profile define this chair made of injected foam. The flexible back gives the chair greater comfort. Choose from various types of base. The folding version is a great space-saving option.

fr Esprit dynamique et profil fin distinguent ce fauteuil en mousse injectée. Son dossier flexible offre un confort accru. De nombreux modèles de piétements sont disponibles. La version à assise pliante présente l'avantage d'un encombrement petit.

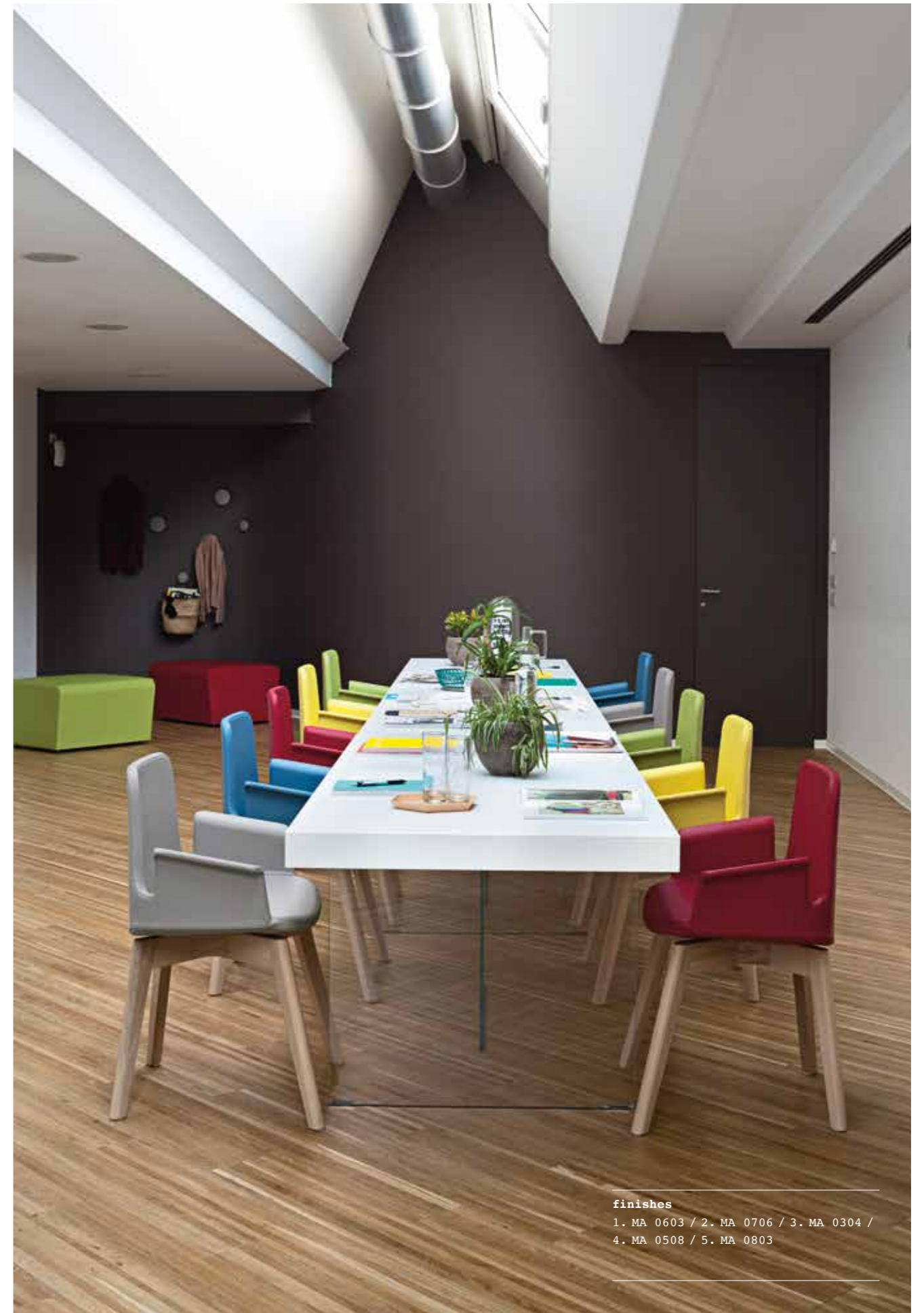

finishes
1. MA 0603 / 2. MA 0706 / 3. MA 0304 /
4. MA 0508 / 5. MA 0803

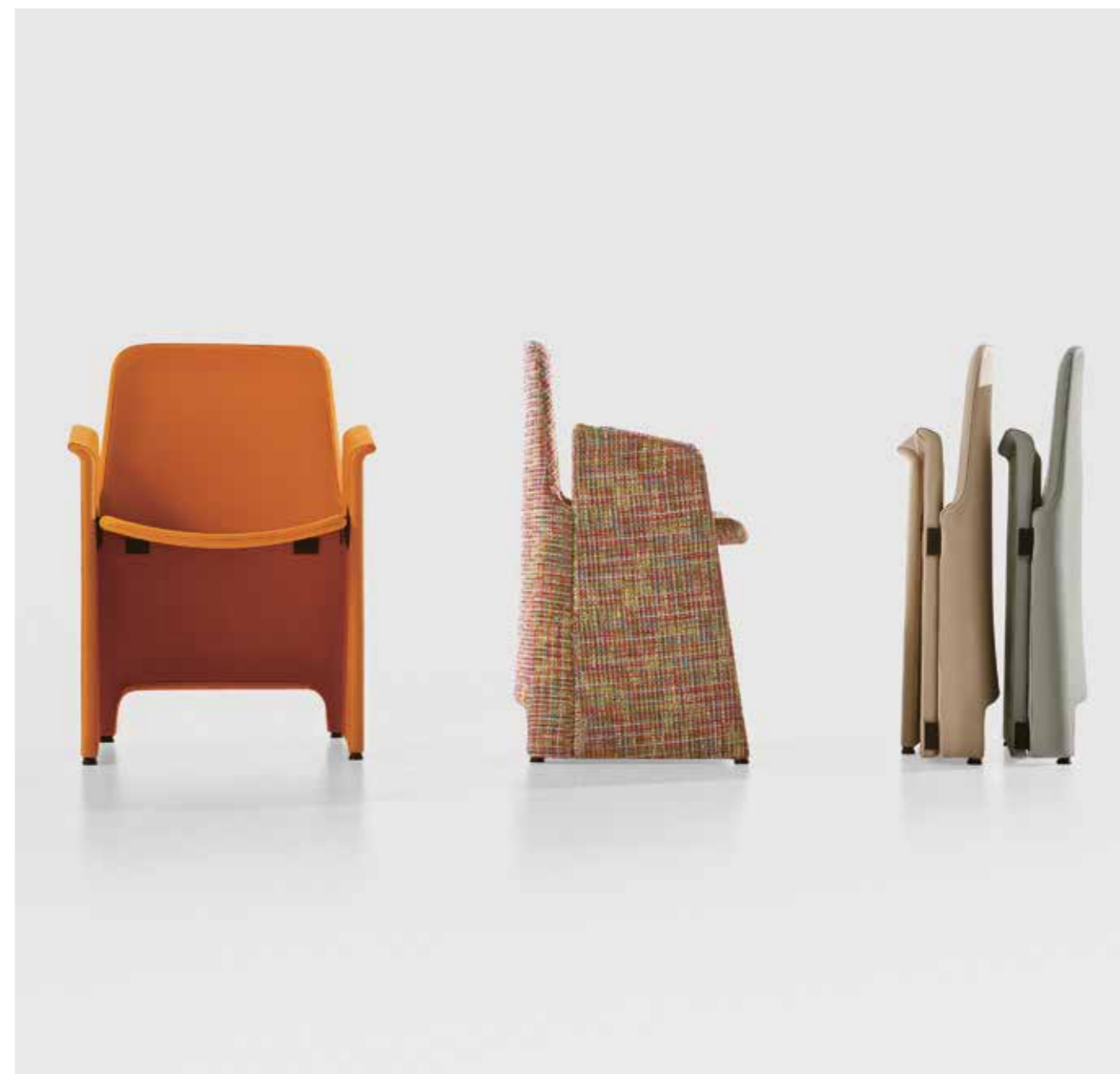

finishes

1. ZS 06KN / 2. EXTRA / 3. MA 0102
/ 4. LN 2523



finishes

1. Kvadrat Rime 0591 / 2. ERA 0029
/ 3. ER 0029 / 4. LN 5478



finishes

1. FE 0453 / 2, 4. FE 0505 / 3. FE 0301

it_Schienale flessibile.
 en_Flexible backrest.
 fr_Dossier flexible.



contract - mirò



finishes
ML 0022

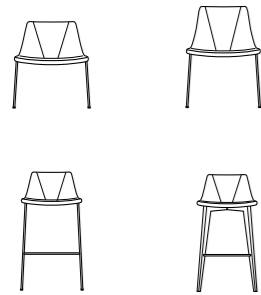

designer
R&D Milani

it_Famiglia di sedute con scocca in legno destinate agli ambienti d'attesa e conferenza. Vengono proposte completamente rivestite e con base a slitta in tondino cromato.

La versione sgabello è offerta anche in versione con base legno. La poltrona lounge può avere anche la base in alluminio a quattro razze e sistema oscillante.

en_A family of chairs made of wood designed for waiting areas and conferences. Available fully upholstered with chromed skid base. The stool version also comes with a wooden base. The lounge version also comes with a four-star aluminium base and tilt system.

fr_Ces sieges à structure en bois sont pensés pour les salles d'attente et les conférences. Entièrement revêtus, ils sont dotés d'un piètement traineau chromé. La version tabouret est offerte aussi avec piètement bois. La version lounge est disponible en piètement avec système basculant en aluminium à quatre branches.



finishes
1. RC 3508 / 2-3. RC 6508



finishes

1. ER 0041 / 2-3. ER 0040 /
4. LN 5432 / 5. LN 3396
-



designer
R&D Milani

it Confortevole poltroncina inseribile in diversi ambienti: dall'ufficio direzionale all'area attesa. Lo schienale dall'ampio raggio e dalle forme gentili offre un piacevole momento di riposo.
en A comfortable armchair suitable for all types of setting: from the boardroom to the waiting area. The pleasant shape and generous curve of the seatback offer a pleasant moment of relaxation.
fr Ce fauteuil confortable peut s'intégrer à différents espaces, allant du bureau de direction à la salle d'attente. Son dossier enveloppant à la forme délicate offre un moment de repos très agréable.



finishes
Rubelli Cortez CZ 0020



-
- finishes**
 1. Rubelli Cortez CZ 0020 /
 2. NE 0331 / 3. ML 0035
-

adalia

264



designer
R&D Milani

it Una linea fluida definisce il volume di questa poltroncina. I raffinati accostamenti cromatici ne consentono l'inserimento in diversi contesti. La seduta e lo schienale sono realizzati in schiumato a freddo ad alta densità. È proposta con base cromata o con base in legno a quattro gambe.

en Flowing lines define the shape of this chair. The sophisticated chrome detailing makes this design suitable for all types of setting. The seat and back are made of high density injected foam. Choose from a chrome base or four wooden legs.

fr Ce fauteuil se caractérise par un volume aux lignes fluides. Les associations de couleurs raffinées permettent une intégration dans différents contextes. Le siège et l'assise sont réalisés en mousse injectée haute densité. Piètement chromé ou en bois à quatre pieds.

265



finishes
Kvadrat Rime RI 0911



finishes

1. Kvadrat Remix 3 MX 0722 /
 2. EXTRA / 3. Kvadrat Remix 3 MX 0753
-



designer
Alessandro Crosera

it_Terre è un pouf bombato, leggero e dinamico. Realizzato in due dimensioni, il bordino può essere in contrasto o in tinta con il rivestimento scelto.
en_Terre is a rounded pouf with a light, dynamic feel. Available in 2 dimensions, the piping can be the same as the chosen covering or in a contrasting colour.
fr_Terre est un pouf rebondi, léger et dynamique. Réalisé en deux dimensions différentes, la couleur du passepoil peut être contrastante ou du même ton que le revêtement choisi.

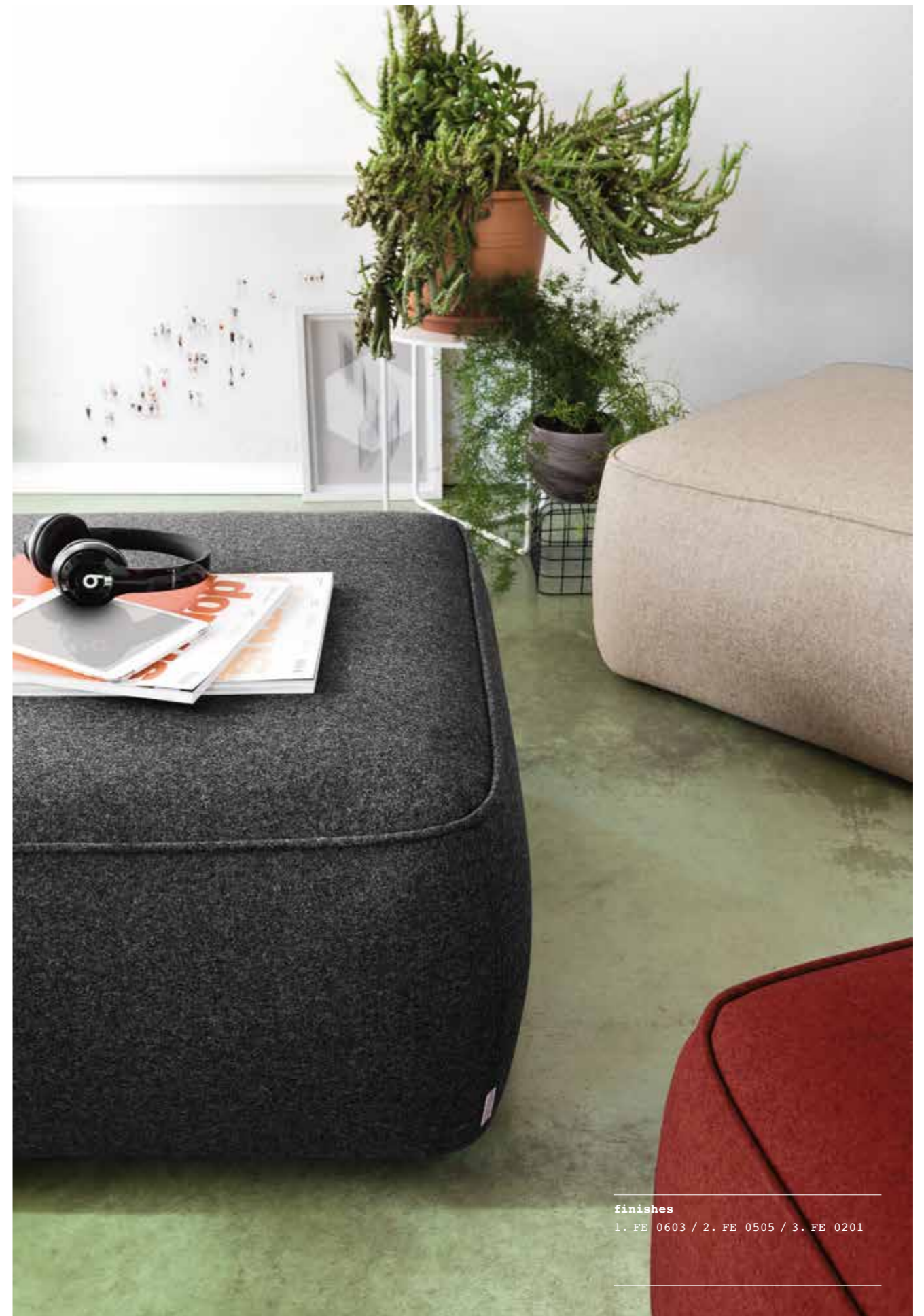

finishes
1. FE 0603 / 2. FE 0505 / 3. FE 0201



finishes
1-2. ML 0035 + ML 0024 /
3. ML 0024 + ML 0013 / 4. ML 0013



designer
C/B Design

it Pensata per i momenti conviviali e di relax, Fungus è perfetta come seduta informale per gli spazi contract. Le sue dimensioni contenute lo rendono un accessorio pratico e divertente. La struttura in plastica è completata dal cuscino ruotante imbottito.

en Created for social occasions and leisure, Fungus is the perfect informal seat for contract spaces. Its compact dimensions make it practical and fun. The plastic body is completed by a round upholstered cushion.

fr Pensé pour les moments conviviaux et de détente, le fauteuil Fungus est parfait dans des contextes informels ou dans les espaces de repos. Ses dimensions réduites en font un accessoire pratique et ludique. Sa structure en plastique est complétée d'un coussin rembourré pivotant.



finishes
1.ER 0041/2.ER 0029



finishes
1. RC 8501 / 2. RC 8030 / 3. RC 6508
/ 4. ZS02F1 / 5. RC 4504 / 6. ER 0040
/ 7. RC 7504

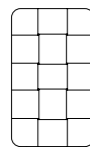
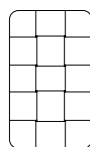

designer
Margherita Rui

patent pending

it_Plot é una linea di pannelli fonoassorbenti dove tessuto, colore e funzione dialogano tra loro. Disponibili da terra o da parete, i pannelli sono pensati per essere affiancati dando vita a un continuo gioco di intrecci. La versione da terra è bifacciale, ed è sostenuta da eleganti piedini in metallo nero.

en_Plot is a line of sound-absorbing panels where fabric, color and function interact with each other. Available on the ground or on the wall, the panels are designed to be placed side by side, creating a continuous game of intertwining. The floor version is double-sided and is supported by elegant black metal feet.

fr_Plot est une ligne de panneaux acoustiques où le tissu, la couleur et la fonction interagissent les uns avec les autres. Disponibles au sol ou au mur, les panneaux sont conçus pour être placés côte à côte, créant un jeu continu d'entrelacs. La version au sol est double face et est soutenue par d'élégants pieds en métal noir.



finishes
RC 1503 + RC 1502



finishes

1,3. RC 5504 + RC 4502 / 2,4. RC 3504
 + RC 5504 / 5. RC 3504 + RC 1503 /
 6. RC 1503 + RC 1502

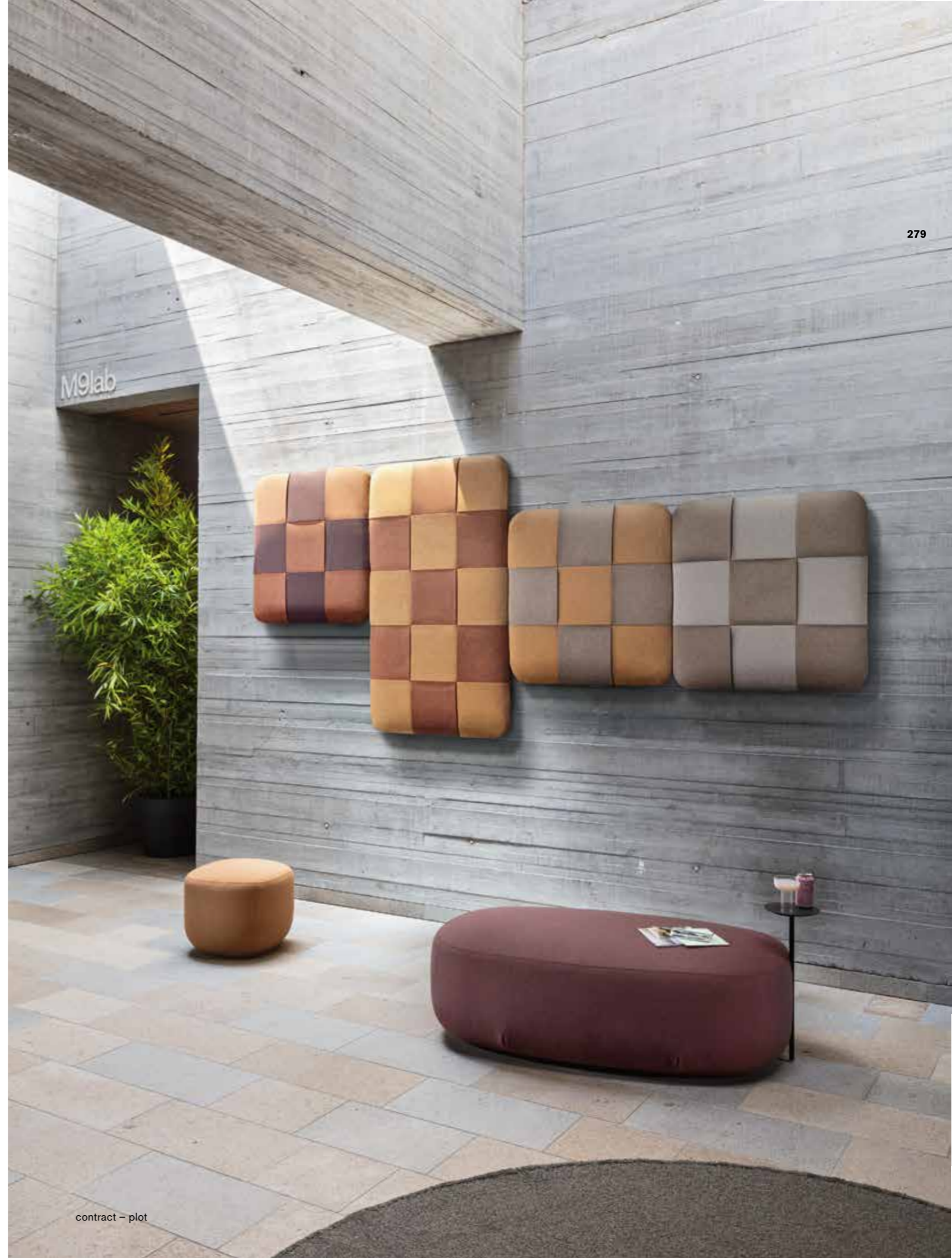



finishes

1. NE 0119 + NE 0234 / 2,5. NE 0572
+ NE 0234 / 3. NE 0572 + NE 0377
/ 4. NE 0377 + N3 0119



finishes
 1-2. RC 6501 + RC 6503
 / 3. NE 0378 / 4. NE 0120 / 5. NE 0333



wait



voilà
p. 288



clark
p. 294



lois
p. 302



role
p. 308



dolly
p. 312



wendy
p. 318



venice
p. 324

conferenza – collettività – attesa

Serie di sedute che si caratterizza per versatilità di utilizzo, dedicata agli spazi per la ristorazione – bar, caffetterie e sale mensa – aree meeting, d'attesa e conferenza. Flessibili e personalizzabili, i modelli combinano tecnica, materiali – plastica e metallo, con rivestimento in cuoio o in tessuto – e colori, nel segno del comfort.

conference – visitor seating

A series of chairs distinguished by their versatility, designed for catering spaces (bars, cafeterias and dining halls), meeting areas, waiting areas and conference venues. Flexible and customisable, these models combine engineering, materials – plastic and metal, with leather or fabric upholstery – and colours to give the ultimate in comfort.

chaises conférence – visiteur

Série de sièges caractérisés par une grande polyvalence, pensés pour les espaces de restauration ou les bars, les cafétérias et les cantines. Flexibles et personnalisables, les modèles associent technique, matériaux tels que le plastique ou le métal revêtus de cuir ou de tissu, et couleurs, toujours sous le signe du confort.

designers

Alessandro Crosera
Orlandini Design
R&D Milani

voilà

288

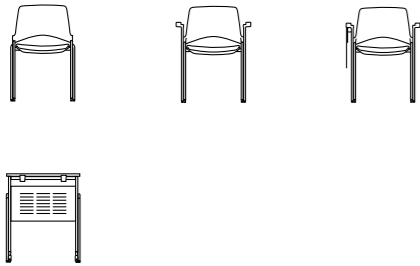

designer
R&D Milani

it Seduta duttile, con sedile ribaltabile, proposta con plastiche a vista o rivestita in tessuto, impilabile anche nella versione con tavolino scrittoio. Abbinata al tavolo ribaltabile crea una famiglia completa e funzionale.

en A flexible chair with a tip up seat, available in plastic or fabric finish and stackable even in the version with writing table. Combined with a foldable table, it forms a complete and fully functional family.

fr Siège maniable à assise pliante, proposé dans les versions plastique ou revêtue, empilable, également disponible dans la version à tablette. Associé à sa table pliante, il forme une famille complète et fonctionnelle.



289

finishes
1. RC 6508 / 2. RC 3508 /
3. RC 3503 / 4. RC 6501 / 5. RC 7504



finishes

1-3. PXV 033 / 4. PXV 034 / 5. PXV
034 + RC 4504 / 6. PXV 034 + RC 4504



finishes

1. RC 6508 / 2. RC 6501 / 3. RC
7504 / 4. RC 3508 / 5. RC 3503



finishes

6. PXV 033 + NE 0643

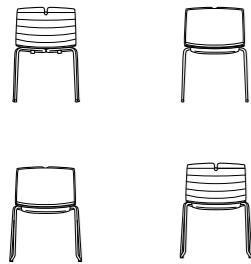

designer
Orlandini Design

it Seduta dal design senza tempo e dalle molteplici combinazioni cromatiche: è possibile scegliere il colore delle scocche in plastica, del bottone applicato sul retro e del sotto sedile. Proposta anche in versione imbottita e in due tipologie di base: a base slitta o a quattro gambe.

en A chair with a timeless design and with endless possible colour combinations: choose the colour of the plastic body, the button feature on the back and the under seat. Also available upholstered and with two types of bases: skyd frame or 4 legged frame.

fr Siège au design intemporel et aux multiples combinaisons de couleurs: il est possible de choisir la couleur des structures en plastique, du bouton à l'arrière et du dessous de l'assise. Proposé dans la version rembourrée et deux piètements différents: pied traineau ou à quatre pieds.



finishes
RC 1502 + PXC 052 + B010



finishes

1. MI 7007 + PCX 052 + B070



finishes

3. PXC 010 + B053 / 4. Kvadrat Remix 3
MX 0753 + PXC 070 + B070



it_Clark, caratteristiche tecniche.
 en_Clark, technical characteristics.
 fr_Clark, caractéristiques techniques.

it_Sette colori di scocca,
 tre colori di bottone,
 tre colori di sotto sedile.
 en_Seven shell colors,
 three button colors,
 three underseat colors.
 fr_Sept couleurs de coque,
 trois couleurs de bouton,
 trois couleurs de sous assise.

it_Quattro tipi di
 basi in tre finiture.
 en_Four types of
 bases in three finishes.
 fr_Quatre types de
 piétements en trois finitions.



finishes

1. ML 0016 + PXD 070
 2. ML 0007 + PXC010 + B010
-



finishes
 1. ML 0007 + PXC010 + B010 / 2. ML 0035
 + PXC010+ B010 / 3, 5. ML 0022 PXC010
 + B010 / 4. ML 0014 PXC010 + B010

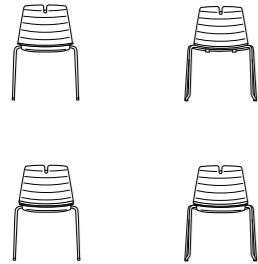

designer
Orlandini Design

it La seduta riprende l'estetica di Clark, anche nel dettaglio del bottone applicato sul retro, è proposta con proporzioni più contenute. È disponibile anche nella versione con sedile imbottito, base slitta o a 4 gambe cromate o verniciate.

en This seat echoes the style of Clark, even down to the button detail featured on the back, but in more compact dimensions. Also available with an upholstered seat, skid base or 4 legged base in chrome or varnished.

fr Siège rappelant l'esthétique de Clark, y compris dans la reprise du détail bouton à l'arrière, ses proportions sont plus réduites. Également disponible dans la version à assise rembourrée, et piètement traineau ou à quatre pieds chromé ou verni.

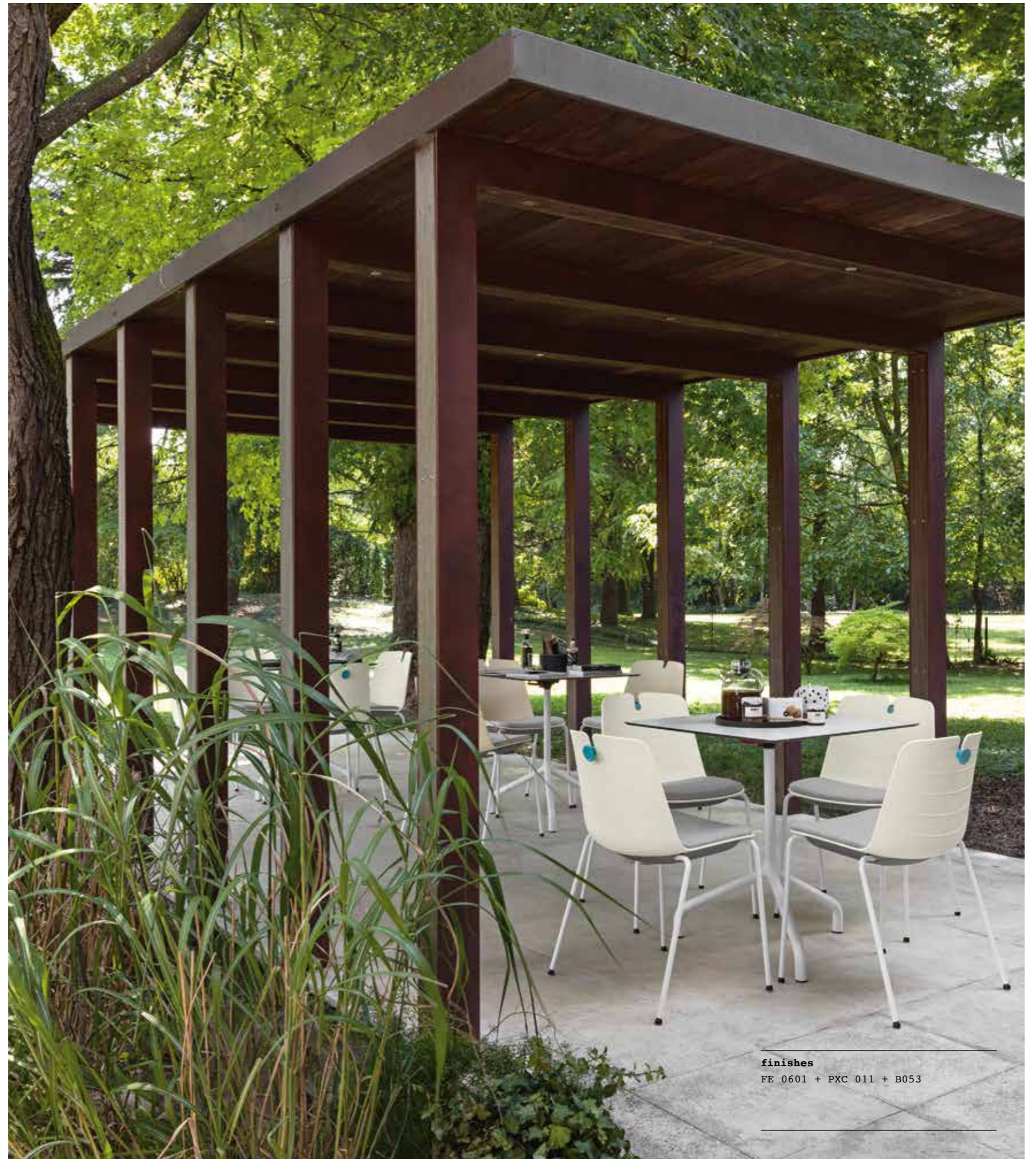

finishes
FE 0601 + PXC 011 + B053



finishes

1. NE 0378 + PXC 050 + B053



finishes

2-7. PXC 010 + B070/B053/B010
8. PXC 035 + B010



finishes

1. FE 0601 + PXC 081 + B053
 2. PXC 010 + PXC 010 + WM 0101
-



designer
R&D Milani

it Il capiente portazaino, il sedile girevole e il tavolino scrittoio orientabile consentono di lavorare dovunque comodamente. Il design funzionale e le numerose cromie, rendono Role il prodotto ideale per gli ambienti accademici.

en With its generous bag holder, swivel seat and writing table, this chair makes it possible to work in comfort anywhere. The functional design and numerous colour options make Role the ideal product for academic settings.

fr Le grand porte-sac, l'assise pivotante et la tablette pivotante de Role permettent de travailler partout et confortablement. Son design fonctionnel et ses nombreux coloris disponibles en font un produit idéal pour les lieux académiques.



finishes
1. PXR 020 / 2. PXR 062 / 3. PXR 072



it_Tavoletta scrittoio
ambidestra e orientabile.
en_Ambidextrous and
directable writing tablet.
fr_Tablette écrioire
ambidextre et orientable.



finishes

1. RC 3503 + PXR 035 / 2-3. PXR 050



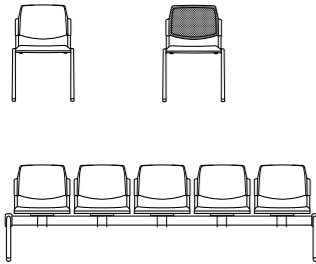

A.

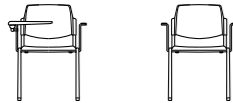

designer
R&D Milani

it Una collezione flessibile e adattabile alle diverse esigenze del mondo contract, dall'ampia gamma di varianti. Disponibile anche su panca nella versione fissa o ribaltabile, in rete, plastica o tessuto.

en A flexible collection that will adapt to the varying requirements of the contract world, thanks to a wide range of options. Also available as a bench in fixed or foldable versions, in mesh, plastic or fabric.

fr Une collection flexible, qui s'adapte aux différentes exigences des lignes détente, avec ses nombreuses variations possibles. Également disponible en version à banquette fixe ou pliante, en résille, plastique ou tissu.



finishes
PXD 090



finishes

1. PXD 031 / 2. MA 0304 + PXD 071
/ 3. NE 0533 + RT 0015 / 4. RC 1501

it_Panca con sedile ribaltabile
automatico.
en_Automatic tip up seat.
fr_Assise rabatable automatique.



finishes
1. NE 0643 / 2. NE 0333

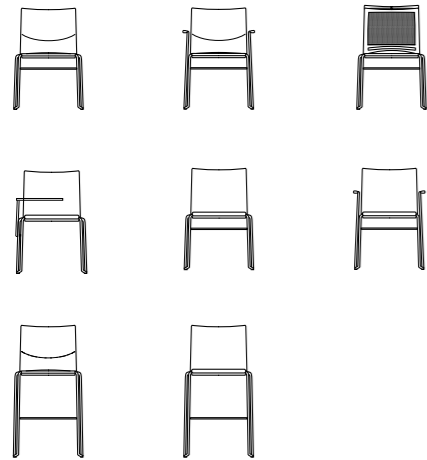

designer
R&D Milani

it Una seduta multifunzionale dal design essenziale, proposta con schienale in rete, in plastica, imbottita o in legno. Le combinazioni sono numerosissime grazie alla possibilità di rivestire anche solo il sedile e di scegliere tra basi in tondino cromato, con o senza braccioli, con tavolino scrittoio o nella versione sgabello.

en A multifunctional chair in a minimalist design, available with a mesh, plastic, upholstered or wooden back. The combinations are endless thanks to the possibility of covering just the seat and choosing between the various chrome skid bases with or without arms, with writing table or in barstool version.

fr Un siège multifonctions au design essentiel, avec dossier en résille, en plastique, rembourré ou en bois. De nombreuses combinaisons sont possibles. Vous pouvez choisir un revêtement pour l'assise seule, un piétement traineau chromé avec ou sans accoudoirs, avec tablette ou en version tabouret.



finishes
ML 0014



finishes

1. RC 3503 / 2, 4, 6. PXW 043 / 3, 5. PXW 044
/ 7. PXW 046 / 8. PXW 041 + RT 0014



finishes

1. ZS 04HJ + PXW 043 / 2. PXW 044
/ 3. RC 5501 / 4. ER 0040 + RT 0022

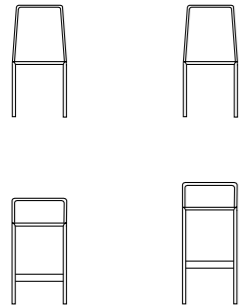

designer
R&D Milani

it Dal design minimale e raffinato, Venice è una seduta multifunzionale, interamente rivestita in cuoio rigenerato o con gambe cromate. È progettata con schienale alto o medio e nella versione sgabello.

en With its elegant, minimalist design, Venice is a multifunctional seat, fully upholstered in recycled bonded leather or with chrome legs. It comes in high-back or medium-back version and as a barstool.

fr Venice, avec son design minimaliste et raffiné, est un siège multifonction, entièrement revêtu de cuir réconstitué ou à pieds chromés. Disponible avec dossier haut ou moyen et dans la version visiteur.

it_Impilabile (x5).
en_Stackable (x5).
fr_Empilable (x5).



finishes
1. CU 0279 / 2-4. CU 0278



finishes
1. CU 0279 / 2. CU 0282 / 3. CU 0273 /
4. CU 0277

sofas and modules sizes

328

bakku p. 200

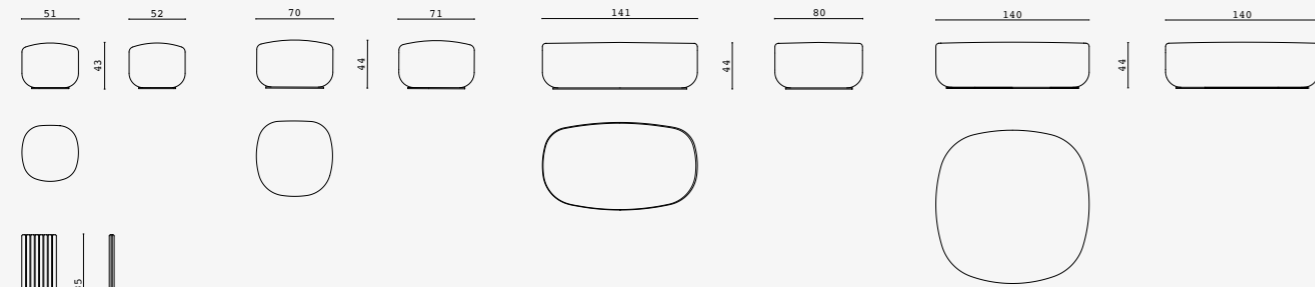

beth p. 180

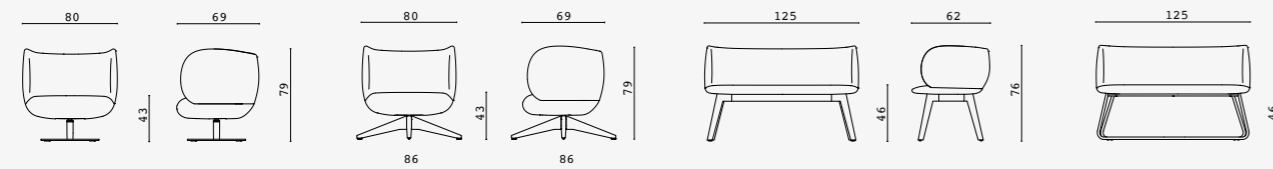

cocktail p. 222

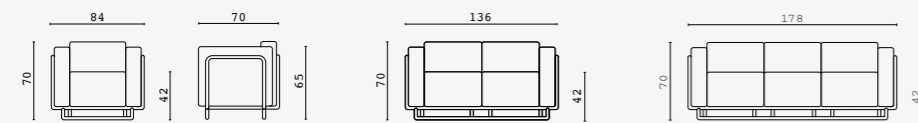

daisy p. 226

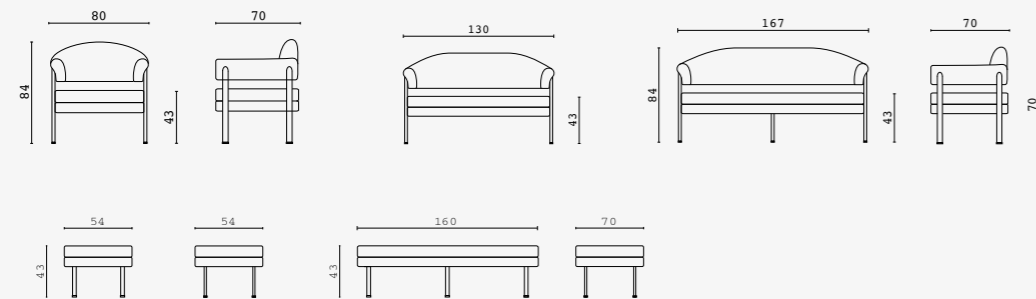

nesis p. 214



nesis chic p. 218

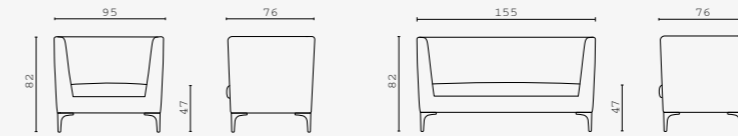

nordic p. 136

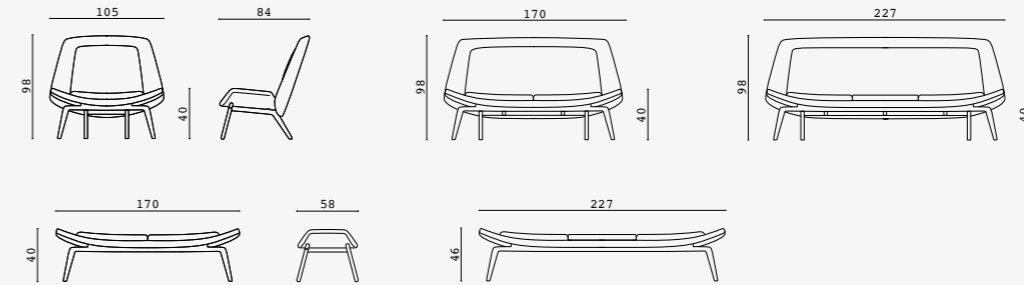

nuvola p. 170

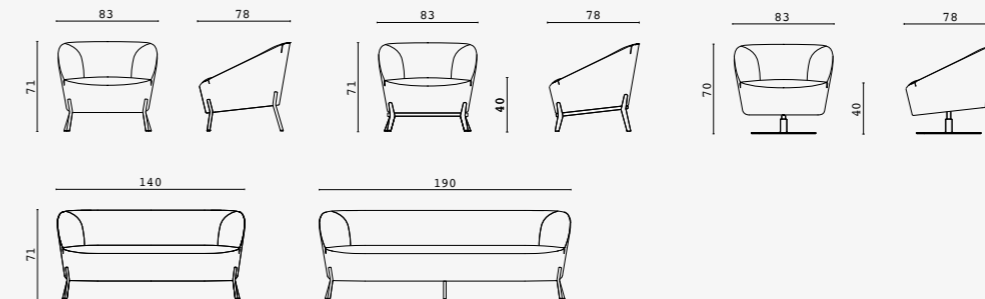

only p. 230

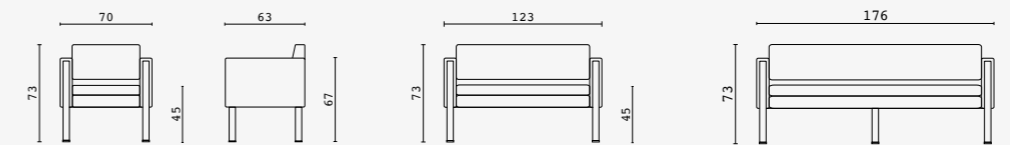

329

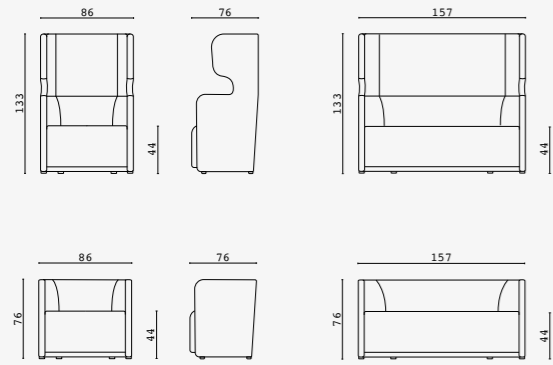

330

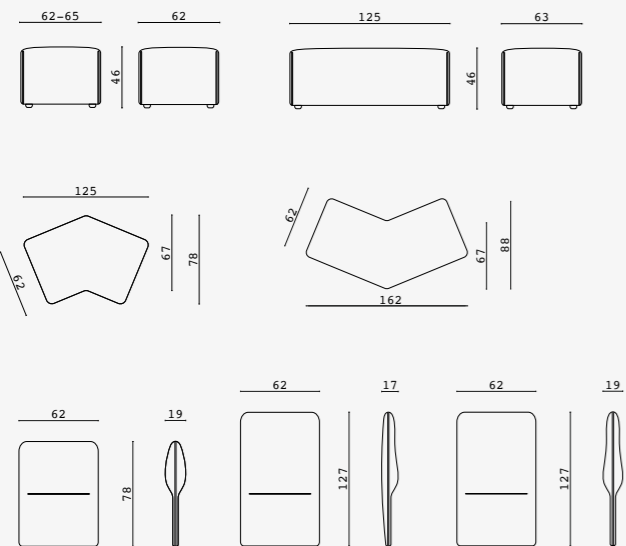
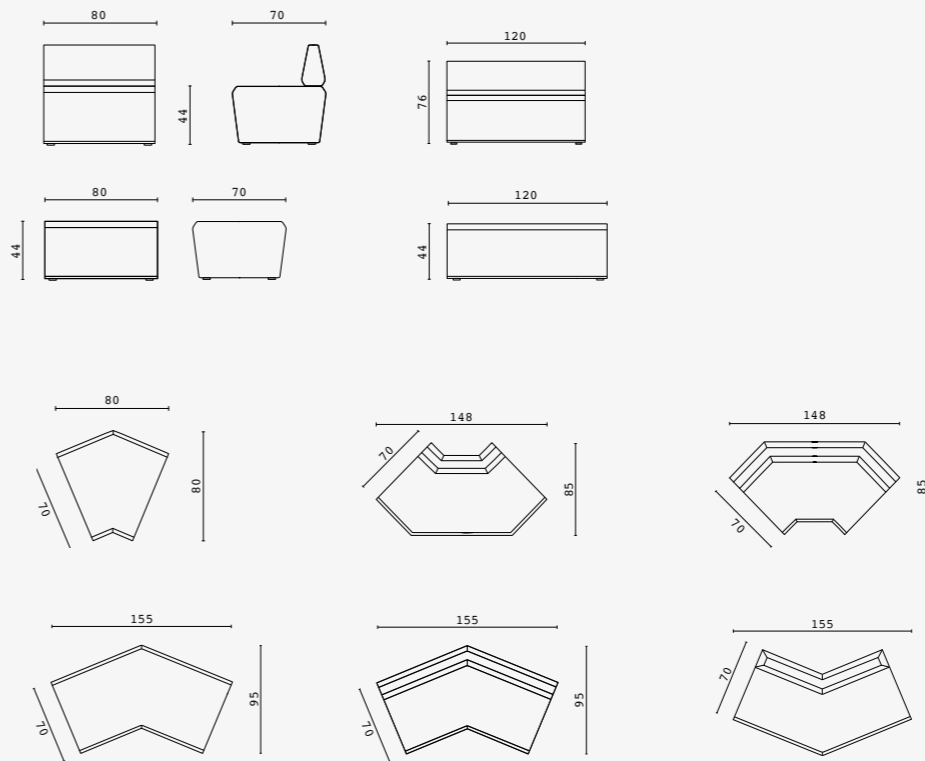
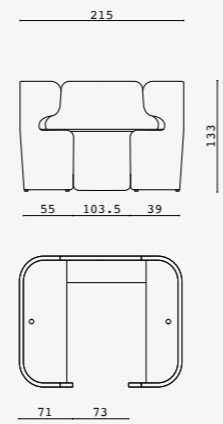
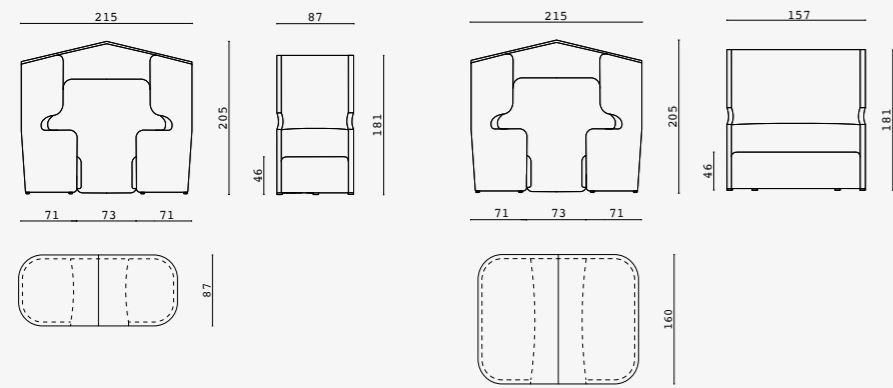



elements



petty
it_Appendiabiti componibile a muro in plastica. *Colori:* bianco, nero.
en_Wall-mounted modular plastic coat hooks. *Colours:* white, black.
fr_Patere modulable en plastique. *Coloris:* blanc, noir.



joy
it_Appendiabiti a colonna con struttura verniciata grigia e ganci in plastica. *Colori:* arancione, nero, trasparente.
en_Column-design coat stand with a grey-painted frame and plastic hooks. *Colours:* orange, black, transparent.
fr_Porte-manteaux colonne à structure vernie grise et crochets en plastique. *Coloris:* orange, noir, transparent.



kasta
it_Portabiti, struttura di metallo con ruote. *Colori:* grigio alluminio.
en_Coat rail with a metal frame and wheels. *Colours:* grey aluminium.
fr_Portant à structure en métal et à roulettes. *Coloris:* gris aluminium.



L/W 150 x P/D 62 x H 161 cm

petalo
it_Appendiabiti verniciato grigio alluminio con ganci portabiti in plastica. *Colori:* nero, blu, verde, arancione.
en_Coat stand in grey-painted aluminium with plastic coat hooks. *Colours:* black, blue, green, orange.
fr_Porte-manteaux verni gris aluminium à crochets en plastique. *Coloris:* noir, bleu, vert, orange.



spicchio
it_Gettacarte in metallo verniciato. *Colori:* grigio, nero.
en_Wastepaper bin in painted metal. *Colours:* grey, black.
fr_Corbeille en métal verni. *Coloris:* gris, noir.



basket
it_Cestino in maglia di metallo. *Colori:* grigio, nero.
en_Bin in perforated metal. *Colours:* grey, black.
fr_Corbeille en maille métallique. *Coloris:* gris, noir.



pot
it_Cestino in materiale plastico. *Colori:* verde, grigio, bordeaux, nero.
en_Plastic bin. *Colours:* green, grey, burgundy, black.
fr_Corbeille en plastique. *Coloris:* vert, gris, bordeaux, noir.



izumi

it_Tavolino da bar, alto o basso, con piano rotondo o quadrato.

Finitura piano: HPL bianco, nero, rosso. *Finitura struttura:* metallo cromato, verniciato bianco, nero, rosso.

en_Bar table, high or low, with round or square top. *Top finish:* white, black or red HPL. *Frame finish:* chromed metal, white, black or red powder coated.

fr_Table de bar, version basse ou mange-debout, plateau rond ou carré. *Finition plateau :* HPL blanc, noir, rouge. *Finition piétement :* métal chromé ou verni blanc, noir, rouge.

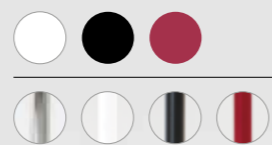

L/W 69 x P/D 69 x H 75 cm

L/W 69 x P/D 69 x H 106 cm

Ø 69 x H 75 cm

Ø 69 x H 106 cm



slim

it_Tavolo con ruote con piano ribaltabile verticalmente. *Finitura piano:* melaminico bianco, nero. *Finitura struttura:* metallo cromato, verniciato nero.

en_Swivel table with vertically folding top. *Top finish:* white or black melamine. *Frame finish:* black powder coated or chromed metal.

fr_Table à roulettes et plateau pliant verticalement. *Finition plateau :* mélaminé blanc, noir. *Finition piétement :* métal chromé ou verni noir.

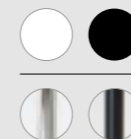

L/W 160 x P/D 80 x H 73 cm

L/W 140 x P/D 80 x H 73 cm



elements

338

skrive

it_Scrivania elevabile elettricamente dalle linee semplici e contemporanee. Sistema elettrico a due motori per una portata massima di 120 kg, led display e 4 posizioni in memoria. 3 finiture di piano e 3 finiture di struttura.

en_Electrified sit-stand desk with simple and contemporary shapes. Dual motor electrical system with 120 kg maximum weight capacity, led display and 4 memory presets. 3 top finishes and 3 frame finishes.

fr_Bureau assis debout électrifié avec lignes simples et contemporaines.

Système à double moteur, led display et 4 mémoires de position. 3 finitions de plateau et 3 finitions de structure.



L/W 180 x P/D 80 cm



benk

it_Bench elevabile elettricamente con sistema a due motori e portata massima di 120 kg per scrivania. Disponibile anche con pannello centrale divisorio e accessori. 3 finiture di piano e 3 finiture di struttura.

en_Electrified sit-stand bench with dual motor electrical and 120 kg maximum weight capacity per desk. Available also with partition panel and accessories. 3 table top finishes and 3 frame finishes.

fr_Bench assis debout électrifié avec double moteur et 120 kg de capacité de charge par bureau. Disponible aussi avec panneau divisoir et accessoires. 3 finitions de plateau et 3 finitions de structure.



L/W 180 x P/D 80 cm



339

only

it Tavolino con piano quadrato o rettangolare. *Finitura piano:* vetro trasparente. *Finitura struttura:* metallo cromato.

en Coffee table with square or rectangular top. *Top finish:* clear glass. *Frame finish:* chromed or anthracite powder coated metal.

fr Table à plateau carré ou rectangulaire. *Finition plateau :* verre transparent. *Finition piétement :* métal chromé ou verni anthracite.



L/W 61 x P/D 61 x H 43 cm
L/W 100 x P/D 61 x H 43 cm



sound

designer Alessandro Crosera

it Tavolino polifunzionale con piano sagomato. *Finitura piano:* MDF laccato bianco, nero o laminato rovere.

Finitura struttura: metallo verniciato bianco o nero.

en Multifunctional coffee table with carved MDF top. *Top finish:* white or black lacquered or laminated oak.

Frame finish: white or black powder coated metal.

fr Table multifonctions à plateau profilé. *Finition plateau :* MDF laqué blanc ou noir ou stratifié chêne. *Finition piétement :* métal verni blanc ou noir.



L/W 28 x P/D 40 x H 69 cm



elements

342

rock

designer Alessandro Crosera

it Tavolino per l'attesa, alto o basso, con piano quadrato. *Finitura piano:* melaminico bianco, tortora, rovere o nero. *Finitura struttura:* metallo cromato, verniciato bianco o nero.

en Waiting area table, in high or low version, with square top. *Top finish:* white, black, taupe or oak melamine. *Frame finish:* white or black powder coated or chromed metal.

fr Table pour salles d'attente, version basse ou haute, plateau carré.

Finition plateau : mélaminé blanc, noir, tourterelle ou chêne.

Finition piètement : métal chromé ou verni blanc ou noir.



L/W 63 x P/D 63 x H 30 cm
L/W 43 x P/D 43 x H 45 cm



343

round

designer Alessandro Crosera

it Tavolino per l'attesa, alto o basso, con piano rotondo. *Finitura piano:* melaminico bianco, tortora, rovere o nero. *Finitura struttura:* metallo cromato, verniciato bianco o nero.

en Waiting area table, in high or low version, with round top. *Top finish:* white, black, taupe or oak melamine. *Frame finish:* white or black powder coated or chromed metal.

fr Table pour salles d'attente, version basse ou haute, plateau rond. *Finition plateau :* mélaminé blanc, noir, tourterelle ou chêne. *Finition piètement :* métal chromé ou verni blanc ou noir.

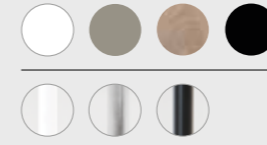

Ø 63 x H 30 cm
Ø 43 x H 45 cm



louise

it_ Sottomani per scrivania,
disponibili in vari rivestimenti.

en_Desk pad, available
in multiple finishes.

fr_Sous mains pour bureau,
disponibles en plusieurs finitions.

L/W 70 x P/D 45 cm

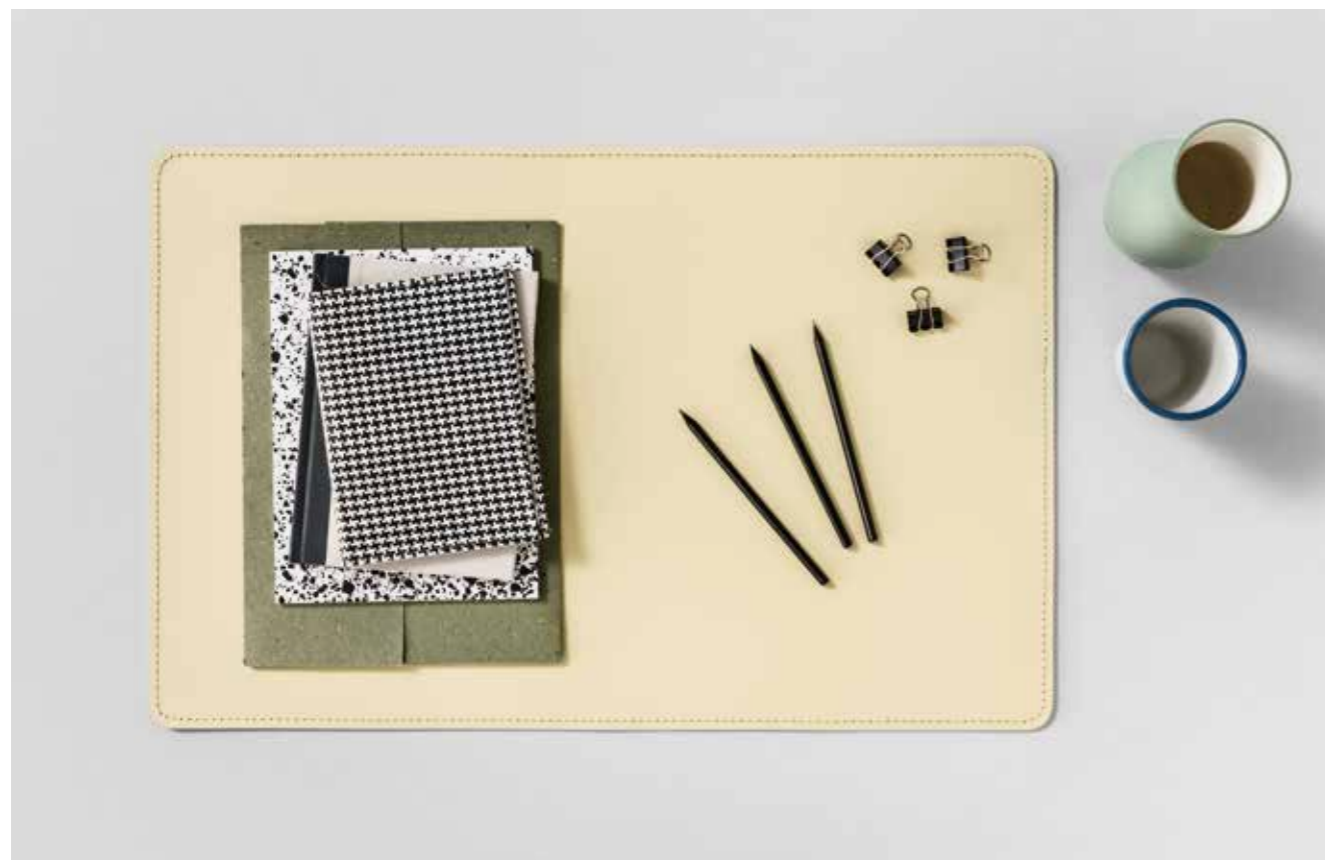

cloud

it_Serie di cuscini disponibili
in tinta unita.

en_Series of cushions available
in solid colours.

fr_Série de coussins à coloris uni.

L/W 47 x P/D 47 cm



MILANI

Milani S.r.l.

**Sede legale/showroom:
via delle Industrie II, 5/7
30020 – Meolo VE**

**Sede operativa/uffici:
via Giorgione, 21
31056 – Roncade TV**

T. +39 0422 1860501

F. +39 0422 1860599

info@sm-milani.com

www.sm-milani.com