



**ESSE SOLUTION**<sup>SAGL</sup>

FORNITURE AZIENDALI

Via Rompada, 37 - CASLANO

+41 076 758 5368 +41 079 709 8354

[www.essesolution.ch](http://www.essesolution.ch) [info@essesolution.ch](mailto:info@essesolution.ch)

**AR**<sup>®</sup> ROSSANESE

## SOMMARIO/SUMMARY

**Esterno / Outdoor** ..... pp. 11-114

### **Interno / Indoor**

Sedie & Poltroncine / *Chairs & Armchairs* ..... pp. 115-237

Poltrone & Divani / *Armchairs & Sofas* ..... pp. 238-269

Sedute ufficio / *Office chairs* ..... pp. 270-283

Sgabelli & Pouf / *Bar stools & Ottoman* ..... pp. 284-313  
pp. 117-133

Tavoli / *Tables* ..... pp. 314-360

Tavolini / *Coffee tables* ..... pp. 361-368

### **Basi e piani per tavoli / Table bases and tops**

Basi per interno / *Outdoor bases* ..... pp. 369-385

Basi per esterno / *Indoor bases* ..... pp. 386-399

Piani per esterno / *Outdoor tops* ..... pp. 400-407

Piani in HPL / *HPL tops* ..... pp. 408-409

Piani per interno / *Indoor tops* ..... pp. 410-411

**Arredi luminosi / Light furniture** ..... pp. 415-424

INDICE / INDEX

SALOTTI PER ESTERNO OUTDOOR LIVING	Pag. 12	Pag. 13	Pag. 14						
	Pag. 15	Pag. 16	Pag. 17						
Pag. 17	Pag. 18		Pag. 18						
Pag. 19	LETTINI / SUNBED								
Pag. 100						Pag. 100	Pag. 101	Pag. 102	Pag. 102
796 - CSL8						1130 - CS21	1554 - A12	1053 - SUN	1546 - JY6F
SEDIE & POLTRONE CHAIRS & ARMCHAIRS	Pag. 20	Pag. 20	Pag. 21	Pag. 22	Pag. 22	Pag. 23	Pag. 25	Pag. 26	Pag. 27
	1636 - E71	1637 - E72	1635 - E70	1641 - SU8A	1640 - SU8	1631 - CH51	1606 - MB4	051 - MC1415	899 - HA30
	Pag. 27	Pag. 30	Pag. 32	Pag. 34	Pag. 34	Pag. 34	Pag. 37	Pag. 37	Pag. 38
	894 - HA50	1581 - MC039	1493 - QF16	810 - C78A	809 - C78	996 - C22	1670 - UEOW	1699 - UE03	1670 - BA01

INDICE / INDEX











Pag. 39  SET 1181 - CA43A	Pag. 39  SET 1297 - CF60	Pag. 40  1242 - CH1	Pag. 42  1189 - T12	Pag. 44  725 - Y19	Pag. 46  1480 - XH3	Pag. 48  1477 - XH8	 Pag. 50  1690 - TG2
---	---	--	--	--	--	--	--

 Pag. 50  1689 - TG1	Pag. 51  1089 - CT619	Pag. 52  1475 - 9A	Pag. 54  1474 - 9C	Pag. 58  1501 - 9D	Pag. 60  1502 - 9E	Pag. 64  1152 - M44	Pag. 66  1298 - M18	Pag. 67  998 - SH15	Pag. 68  818 - U12
--	--	---	---	---	---	---	--	--	---

















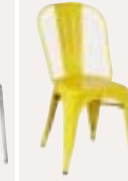







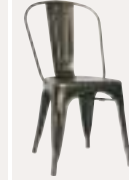



























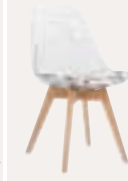
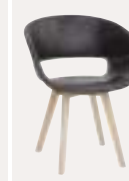

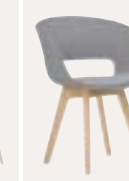

Pag. 69  819 - U13	Pag. 70  1054 - LIB	Pag. 72  1156 - WAM	Pag. 74  1483 - A11	Pag. 76  883 - 180P	Pag. 77  1269 - OW139	Pag. 78  1277 - M25	Pag. 78  802 - Y012	 Pag. 79  1141 - 48L	 Pag. 80  1579 - TJE
---	---	---	---	---	---	--	---	---	---

 Pag. 81  1580 - TVL	Pag. 82  690 - PP	Pag. 83  691 - PL	Pag. 85  1145 - 047	Pag. 86  1161 - E80	Pag. 86  1162 - E80A	Pag. 86  062 - AM10	Pag. 86  063 - AM09	Pag. 87  060 - AM03	Pag. 87  056 - AM02
--	--	--	--	--	---	---	--	--	--

Pag. 87  055 - AM01	Pag. 88  718 - MCR138	Pag. 88  719 - MCR139	Pag. 89  472 - P77	Pag. 89  473 - P78	Pag. 90  015 - ALR92	Pag. 91  016 - ALR95	Pag. 92  946 - 38A	Pag. 93  947 - 39A	Pag. 94  498 - L80801
---	--	--	---	---	---	--	---	---	--

Pag. 95  499 - L80804	Pag. 104  020 - ALR12	Pag. 105  024 - ALR04	Pag. 105  026 - ALR06	Pag. 106  035 - ALW01	Pag. 106  037 - ALW04	Pag. 106  043 - ALW12	Pag. 106  039 - ALW06	Pag. 107  038 - ALW05	Pag. 107  040 - ALW07
---	--	--	--	--	--	---	--	--	--

INDICE / INDEX

Pag. 109  001 - ALL01	Pag. 109  004 - ALL04	Pag. 109  005 - ALL05	Pag. 109  006 - ALL06	Pag. 110  454 - ALL33	Pag. 110  007 - ALL07	Pag. 116  976 - ET53	Pag. 118  978 - EM35W	Pag. 122  1100 - M51	Pag. 125  971 - MC001B
Pag. 126  969 - MC001T	Pag. 126  1066 - MC001TW	Pag. 129  1427 - 01N	Pag. 129  1428 - 01NW	Pag. 130  968 - MC001D	Pag. 130  1077 - MC001DW	Pag. 134  1464 - 05A	Pag. 135  1431 - MC001A	Pag. 135  1432 - MC001AW	 Pag. 136 1661 - DA3
 Pag. 136 1662 - DA4	 Pag. 137 1652 - J02	 Pag. 138 1638 - DH2	 Pag. 139 1186 - HT35	 Pag. 140 1188 - HT36	 Pag. 142 1673 - PA1	 Pag. 142 1674 - PA2	 Pag. 143 1650 - PA3	 Pag. 143 1692 - PA4	 Pag. 144 1041 - C25
 Pag. 146 1124 - M07	 Pag. 147 1036 - G02	 Pag. 148 1037 - G03	 Pag. 150 1484 - AR7	 Pag. 152 1585 - S37R	 Pag. 153 1584 - S37	 Pag. 153 1582 - S37A	 Pag. 154 1014 - JK5	 Pag. 155 1683 - ST23	 Pag. 156 1525 - D24
 Pag. 158 1322 - Z87	 Pag. 160 1593 - XH2P	 Pag. 161 1144 - 62F	 Pag. 161 1320 - W2C	 Pag. 162 1489 - YG99	 Pag. 163 1587 - YG101	 Pag. 164 1586 - YG100	 Pag. 165 1492 - YG94	 Pag. 166 1423 - YM2	 Pag. 166 1422 - YM1
 Pag. 167 1626 - EV10	 Pag. 168 1682 - ST77	 Pag. 169 1438 - C50W	 Pag. 169 1439 - C50P	 Pag. 170 1335 - W58	 Pag. 172 1335 - W58	 Pag. 174 1334 - B91	 Pag. 176 1524 - D22	 Pag. 176 1523 - D23	 Pag. 178 1185 - PW07

INDICE / INDEX

Pag. 180  1150 - 72B	Pag. 181  1193 - PW72	Pag. 182  1148 - 72K	Pag. 183  1057 - PW022	Pag. 183  1092 - FL08W	Pag. 185  1103 - NET08	Pag. 186  1419 - ITP3	Pag. 187  926 - JY05	Pag. 187  1035 - D060	Pag. 189  1451 - 7BD
--	--	---	---	---	---	---	---	--	---

Pag. 189  1456 - 30D	 Pag. 191  1615 - T0P8	Pag. 192  1528 - T07	 Pag. 193  1693 - F450	 Pag. 194  1601 - 82P	 Pag. 194  1602 - 82C	Pag. 195  821 - RF49C	Pag. 196  825 - RF49P	Pag. 198  1105 - RF91	Pag. 199  1020 - SS95
--	--	---	--	---	---	---	--	--	--

 Pag. 200  1613 - T0P6	 Pag. 201  1614 - T0P7	Pag. 202  1485 - F50	Pag. 203  1482 - F442	Pag. 204  949 - F400	Pag. 205  948 - F503	Pag. 206  824 - RF97	Pag. 208  837 - C4135	Pag. 209  608 - C2406	Pag. 211  593 - C2842
---	---	--	---	--	--	---	---	---	---

Pag. 212  1329 - CQ04	Pag. 214  1259 - M0120C	Pag. 215  888 - ISA	Pag. 215  889 - PC492	 Pag. 216  1589 - YG103	Pag. 217  1486 - YG91	 Pag. 218  1625 - EV24	 Pag. 219  1623 - EV03	 Pag. 219  1686 - EVC03	 Pag. 220  1622 - EV07
---	--	--	--	---	--	---	--	---	--

 Pag. 220  1687 - EVC07	 Pag. 221  1624 - EV012	 Pag. 221  1685 - EVC12	Pag. 222  893 - CT390	Pag. 223  074 - CT123	Pag. 224  922 - CT20	Pag. 225  626 - KG1C	Pag. 226  219 - 1153-1	Pag. 227  697 - Y30S	Pag. 228  616 - PP8165
---	---	---	--	--	---	--	---	---	---









Pag. 229  590 - K18C	Pag. 230  710 - KC07	Pag. 231  343 - AB47T	Pag. 232  1101 - BS001MC	Pag. 233  263 - AB027T	Pag. 234  670 - PE001T	Pag. 235  871 - MC4C	Pag. 236  267 - AB001T	Pag. 237  083 - AR100
--	---	--	---	---	---	--	---	--

INDICE / INDEX





POLTRONE ARMCHAIRS	 Pag. 191	 Pag. 238	 Pag. 240	 Pag. 244	 Pag. 246	 Pag. 248	 Pag. 249	 Pag. 250	 Pag. 252
	1616 - TOP9	1520 - S8V	1605 - 06P	1121 - C12P	1191 - S01	1657 - FU2P	1664 - TF21	625 - C2816	836 - C4041

 Pag. 254	 Pag. 255	 Pag. 256	 Pag. 258	 Pag. 259	 Pag. 260	 Pag. 264	 Pag. 266	 Pag. 268	 Pag. 269
1633 - GU34	1660 - DA2	1659 - DA1	1612 - TOP5	1240 - V61	432 - X17P	1509 - D062	1340 - FE1	1618 - TOP11	1000 - JY06

POOF / SGABELLI OTTOMAN / BARSTOOLS	 Pag. 242	 Pag. 117	 Pag. 127	 Pag. 131	 Pag. 184	 Pag. 313	 Pag. 120	 Pag. 120	 Pag. 124
	1603 - 06T	1084 - BT18	1264 - 010T	1263 - 009T	1143 - M2	1123 - D600	977 - BT503	955 - MC012	1295 - BT03

 Pag. 127	 Pag. 127	 Pag. 129	 Pag. 131	 Pag. 131	 Pag. 133	 Pag. 139	 Pag. 140	 Pag. 149	 Pag. 149
966 - MC012T	1060 - MC012PT	1496 - BT04	1061 - MC012D	1062 - MC012DT	1417 - BM37	1440 - HT38	1321 - HT37	1258 - G04L	1038 - G04

 Pag. 153	 Pag. 154	 Pag. 155	 Pag. 191	 Pag. 284	 Pag. 285	 Pag. 286	 Pag. 287	 Pag. 288	 Pag. 289
1583 - S847	1015 - JK5B	1684 - ST23A	1617 - TOP10	1651 - J01G	1007 - F600	1497 - K31	1303 - PW026	1655 - FU95	1500 - K32

 Pag. 290	 Pag. 290	 Pag. 291	 Pag. 292	 Pag. 293	 Pag. 294	 Pag. 295	 Pag. 296	 Pag. 297	 Pag. 298
1639 - EV37	1627 - EV36	646 - AB047BB	442 - BB010	932 - K38	443 - CT123-1	815 - C77	221 - B1201	838 - C4063	1630 - EV23

INDICE / INDEX

Pag. 299  513 - A661A	Pag. 300  223 - B010	Pag. 301  245 - B030	Pag. 302  512 - A174	Pag. 303  997 - K3001	Pag. 304  1113 - BY035	 Pag. 305 1566 - V12	Pag. 306  933 - K08	Pag. 307  934 - K00	Pag. 308  1031 - 795
--	---	---	---	--	---	--	--	--	---

Pag. 309  595 - T010	Pag. 310  528 - 238A	Pag. 311  531 - 219B	Pag. 312  419 - IF216
---	---	---	--

PANCHE & DIVANI BENCHES & SOFAS	Pag. 263  1331 - CQ02	Pag. 213  1332 - CQ13
------------------------------------	---	--

 Pag. 239 1604 - 06S	 Pag. 244 1122 - C12S	 Pag. 246 1192 - S02	 Pag. 259 1241 - V61D	 Pag. 261 475 - X17D2
---	---	--	--	---

 Pag. 265 1510 - D080	SEDUTE E UFFICIO OFFICE CHAIRS	 Pag. 270 1643 - 4BC2	 Pag. 271 1642 - 4B2	 Pag. 272 762 - LS31	 Pag. 273 763 - LS30	 Pag. 274 764 - LS11	 Pag. 275 765 - LS10	 Pag. 276 1237 - HM2
---	-----------------------------------	--	---	---	--	---	---	---

 Pag. 276 1238 - MM2	 Pag. 276 1239 - VM2	 Pag. 277 1234 - HL1	 Pag. 277 1235 - ML1	 Pag. 277 1236 - VL1	 Pag. 278 529 - W81	 Pag. 279 671 - W03	 Pag. 280 1628 - EV11	 Pag. 281 1491 - YG98	 Pag. 282 1126 - K03
--	---	---	---	---	--	---	--	--	---









 Pag. 283 669 - WX910	TAVOLI / TABLES	 Pag. 28 906 - HA38	 Pag. 35 128 - MA01A	 Pag. 35 1526 - HY18	 Pag. 75 1300 - M40	 Pag. 84 1044 - S15	 Pag. 96 560 - CTS0022	 Pag. 96 561 - MCQ 80	 Pag. 108 109 - MTW006A
---	-----------------	--	---	---	--	---	---	--	--











INDICE / INDEX

Pag. 108  678 - MTW011A	Pag. 112  092 - MTA003A	Pag. 112  097 - MTA013A	Pag. 113  102 - MTA016K	Pag. 118  1265 - 70W	 Pag. 119  1649 - 80WA	Pag. 121  1266 - CT60	 Pag. 123  1575 - 36WA	Pag. 126  1262 - 236D	Pag. 128  1267 - GT24
---	--	--	--	---	--	---	--	--	--

Pag. 130  956 - 36D	Pag. 132  1268 - GT28	Pag. 314  1665 - TF22	Pag. 316  1442 - A58	Pag. 318  1442 - A58	Pag. 320  1445 - A75G
---	--	--	---	--	--

Pag. 322  1324 - A75	 Pag. 324  1608 - TOP1	 Pag. 326  1658 - RI9A	 Pag. 328  1609 - TOP2	 Pag. 330  1610 - TOP3
---	---	---	--	---

 Pag. 332  1694 - DE93T	 Pag. 333  1594 - DE86T	Pag. 334  1539 - WL01	Pag. 335  1447 - T21	 Pag. 336  1621 - MIT83
--	---	--	--	---

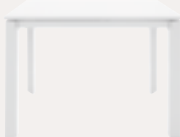
 Pag. 336  1675 - MIT82	 Pag. 337  1677 - MIT10	 Pag. 337  1676 - MIT67	 Pag. 338  1634 - GU33	Pag. 339  1450 - 28DT
---	---	---	---	--

Pag. 340  1458 - 18DT	Pag. 342  1457 - 65DT	Pag. 344  1455 - 75DTG	Pag. 348  1459 - 88DT	Pag. 350  1460 - 78DT
--	--	---	---	--

INDICE / INDEX

Pag. 352  1461 - 03DT	Pag. 355  509 - TB015	Pag. 356  1562 - TB08	Pag. 357  938 - K54	Pag. 358  1040 - G06	Pag. 359  944 - Z152
-----------------------------	-----------------------------	-----------------------------	---------------------------	----------------------------	----------------------------

Pag. 360  537 - CS205	Pag. 360  538 - CS206	 Pag. 363 1653 - B01T	Pag. 367  1565 - TS7
-----------------------------	-----------------------------	-----------------------------	----------------------------

<b>BASI / TABLE BASES</b>	 Pag. 370 1648 - EG3	 Pag. 370 1644 - S10	 Pag. 370 1646 - EG2	 Pag. 370 1645 - EG1	 Pag. 371 1680 - BB07
---------------------------	----------------------------	----------------------------	----------------------------	----------------------------	-----------------------------

Pag. 372  980 - TB015S	Pag. 373  1354 - T40RU	Pag. 374  363 - 6032I	Pag. 374  364 - 6032C	Pag. 374  365 - 340N	Pag. 374  365 - 340N	Pag. 374  365 - 340N	Pag. 376  411 - 6028I	Pag. 376  414 - 6028C	Pag. 376  360 - 340N
------------------------------	------------------------------	-----------------------------	-----------------------------	----------------------------	----------------------------	----------------------------	-----------------------------	-----------------------------	----------------------------

Pag. 376  360 - 340N	Pag. 376  360 - 340N	Pag. 378  165 - CI159	Pag. 378  166 - CI160	Pag. 378  779 - TB131	Pag. 379  159 - CI110A	Pag. 380  402 - 6033I	Pag. 380  773 - 341C	Pag. 380  403 - 341M	Pag. 380  403 - 341M
----------------------------	----------------------------	-----------------------------	-----------------------------	-----------------------------	------------------------------	-----------------------------	----------------------------	----------------------------	----------------------------

Pag. 382  156 - CI129	Pag. 382  157 - CI130	Pag. 383  366 - 313	Pag. 384  1351 - T11BR	Pag. 385  170 - CI155-4	Pag. 386  153 - CA102	Pag. 387  155 - CA102B	Pag. 388  611 - F3	Pag. 390  973 - TP	Pag. 390  973 - TP
-----------------------------	-----------------------------	---------------------------	------------------------------	-------------------------------	-----------------------------	------------------------------	--------------------------	--------------------------	--------------------------

Pag. 392  180 - CS2014	Pag. 394  136 - B	Pag. 395  134 - C	Pag. 396  143 - OA	Pag. 397  1412 - TB77	Pag. 399  1349 - B80
------------------------------	-------------------------	-------------------------	--------------------------	-----------------------------	----------------------------

<b>PIANI PER ESTERNO OUTDOOR TOPS</b>	Pag. 400  TEAK	Pag. 401  ACCIAIO	Pag. 401  IN LEGNO
---	----------------------	-------------------------	--------------------------

INDICE / INDEX

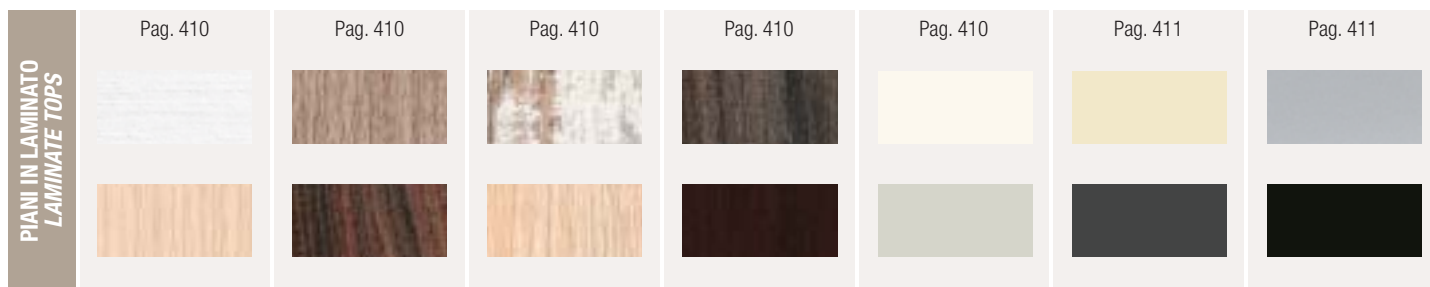
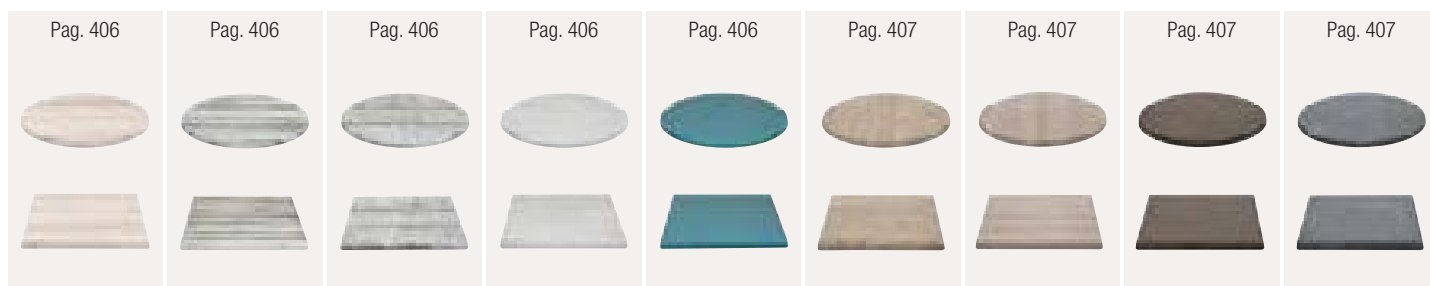

Su richiesta / On demand

PIANI IN MELAMMINICO & LAMINATO **PERSONALIZZATI**  
*CUSTOM MADE MELAMINE & LAMINATED TOPS*

PIANI IN STRATIFICATO HPL **PERSONALIZZATI**  
*CUSTOM MADE HPL PRESSURE LAMINATE TOPS*



# Esterno

**ESSE SOLUTION**<sub>SAGL</sub>

*FORNITURE AZIENDALI*

*Via Rompada, 37 - CASLANO*

*+41 076 758 5368 +41 079 709 8354*

*[www.essesolution.ch](http://www.essesolution.ch) [info@essesolution.ch](mailto:info@essesolution.ch)*

# Outdoor



1176 - MA56  
(L78 x P78 x H70 cm)



1177 - MA55  
(L76 x P78 x H70 cm)



1178 - MA54S  
1179 - MA54D  
(L82 x P78 x H70 cm)



1180 - MA57  
(L78 x P78 x H70 cm)



1175 - MA53A  
(L78 x P78 x H30 cm)



1194 - MA53B  
(L76 x P76 x H31 cm)

Struttura in alluminio verniciato,  
cuscini in tessuto  
*Aluminum frame, powder coating,  
fabric cushions*



SET 1512 - A4P

POLTRONA ARMCHAIR  
(L75 x P71 x H64 cm)

DIVANO SOFA  
(L162 x P71 x H64 cm)

TAVOLINO COFFEE TABLE  
(L100 x P55 x H45 cm)

Struttura in alluminio verniciato, cuscini in tessuto  
*Aluminum frame, powder coating, fabric cushions*



☐ POLTRONA *ARMCHAIR*  
1114 - HM05A  
(L81 x P70 x H62,5 cm)

☐ DIVANO *SOFA*  
1115 - HM05B  
(L144 x P70 x H62,5 cm)

☐ TAVOLINO *COFFEE TABLE*  
1116 - HM05E  
(L100 x P60 x H41 cm)

Struttura in alluminio satinato,  
cuscini in tessuto

*Satin aluminum frame,  
fabric cushions*



POLTRONA *ARMCHAIR*  
1599 - S1S  
(L50 x P55 x H67 cm)

DIVANO *SOFA*  
1598 - S1D  
(L113 x P55 x H67 cm)

TAVOLINO *COFFEE TABLE*  
1600 - S1F  
(L44 x P68 x H32 cm)

struttura / frame



W T

Struttura in polipropilene  
con fibra di vetro,  
cuscini idrorepellenti

*Polipropylene frame with fiber  
glass waterproof cushions*



NEW



SET 1632 - CH14

POLTRONA *ARMCHAIR*  
(L75 x P67 x H61 cm)

DIVANO *SOFA*  
(L184 x P67 x H61 cm)

TAVOLINO *COFFEE TABLE*  
(L57 x P120 x H44 cm)

Struttura in alluminio verniciato, cuscini in tessuto  
*Aluminum frame powder coating, fabric cushions*

struttura / frame



W T



# Esterno

**ESSE SOLUTION**<sub>SAGL</sub>

*FORNITURE AZIENDALI*

*Via Rompada, 37 - CASLANO*

*+41 076 758 5368 +41 079 709 8354*

*[www.essesolution.ch](http://www.essesolution.ch) [info@essesolution.ch](mailto:info@essesolution.ch)*

# Outdoor



1176 - MA56  
(L78 x P78 x H70 cm)



1177 - MA55  
(L76 x P78 x H70 cm)



1178 - MA54S  
1179 - MA54D  
(L82 x P78 x H70 cm)



1180 - MA57  
(L78 x P78 x H70 cm)



1175 - MA53A  
(L78 x P78 x H30 cm)



1194 - MA53B  
(L76 x P76 x H31 cm)

Struttura in alluminio verniciato,  
cuscini in tessuto  
*Aluminum frame, powder coating,  
fabric cushions*



SET 1512 - A4P

POLTRONA ARMCHAIR  
(L75 x P71 x H64 cm)

DIVANO SOFA  
(L162 x P71 x H64 cm)

TAVOLINO COFFEE TABLE  
(L100 x P55 x H45 cm)

Struttura in alluminio verniciato, cuscini in tessuto  
*Aluminum frame, powder coating, fabric cushions*



POLTRONA *ARMCHAIR*  
1114 - HM05A  
(L81 x P70 x H62,5 cm)

DIVANO *SOFA*  
1115 - HM05B  
(L144 x P70 x H62,5 cm)

TAVOLINO *COFFEE TABLE*  
1116 - HM05E  
(L100 x P60 x H41 cm)

Struttura in alluminio satinato,  
cuscini in tessuto

*Satin aluminum frame,  
fabric cushions*



POLTRONA *ARMCHAIR*  
1599 - S1S  
(L50 x P55 x H67 cm)

DIVANO *SOFA*  
1598 - S1D  
(L113 x P55 x H67 cm)

TAVOLINO *COFFEE TABLE*  
1600 - S1F  
(L44 x P68 x H32 cm)

struttura / frame



W T

Struttura in polipropilene  
con fibra di vetro,  
cuscini idrorepellenti

*Polipropylene frame with fiber  
glass waterproof cushions*

NEW



SET 1632 - CH14

POLTRONA *ARMCHAIR*  
(L75 x P67 x H61 cm)

DIVANO *SOFA*  
(L184 x P67 x H61 cm)

TAVOLINO *COFFEE TABLE*  
(L57 x P120 x H44 cm)

Struttura in alluminio verniciato, cuscini in tessuto  
*Aluminum frame powder coating, fabric cushions*

struttura / frame



W

T



POLTRONA *ARMCHAIR*  
394 - WS091P  
(L68 x P77 x H80 cm)

TAVOLINO *COFFEE TABLE*  
393 - WS091T  
(L100 x P60 x H44 cm)

DIVANO *SOFA*  
395 - WS091D  
(L141 x P77 x H80 cm)

Struttura in alluminio, rivestimento in piattina di polietilene / *Aluminum frame, polyethylene strap covering*



W



N



Struttura in alluminio verniciato,  
rivestimento in piattina di polietilene, piano in teak,  
cuscini idrorepellenti

*Aluminum frame, powder coating,  
polyethylene strap covering,  
waterproof cushions*

1296 - BAR1

POLTRONA *ARMCHAIR*  
(L60 x P65 x H81 cm)

DIVANO *SOFA*  
(L130 x P65 x H81 cm)

TAVOLINO *COFFEE TABLE*  
(L110 x P70 x H45 cm)





POLTRONA *ARMCHAIR*  
394 - WS091P  
(L68 x P77 x H80 cm)

TAVOLINO *COFFEE TABLE*  
393 - WS091T  
(L100 x P60 x H44 cm)

DIVANO *SOFA*  
395 - WS091D  
(L141 x P77 x H80 cm)

Struttura in alluminio, rivestimento in piattina di polietilene / *Aluminum frame, polyethylene strap covering*



W

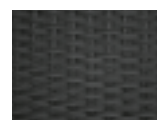

N



Struttura in alluminio verniciato,  
rivestimento in piattina di polietilene, piano in teak,  
cuscini idrorepellenti

*Aluminum frame, powder coating,  
polyethylene strap covering,  
waterproof cushions*

1296 - BAR1

POLTRONA *ARMCHAIR*  
(L60 x P65 x H81 cm)

DIVANO *SOFA*  
(L130 x P65 x H81 cm)

TAVOLINO *COFFEE TABLE*  
(L110 x P70 x H45 cm)



POLTRONA *ARMCHAIR*  
571 - CS0109A  
(L76 x P70 x H67 cm)

DIVANO *SOFA*  
750 - CS0109  
(L140 x P70 x H67 cm)

TAVOLINO *COFFEE TABLE*  
575 - CS0109T  
(L70 x P70 x H29 cm)

Struttura in alluminio, rivestimento  
in piattina di polietilene

*Aluminum frame, polyethylene  
strap covering*



W



N

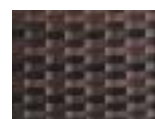

M



POLTRONA *ARMCHAIR*  
280 - GF06681  
(L65 x P66 x H88 cm)

DIVANO *SOFA*  
283 - GF06682  
(L115 x P66 x H88 cm)

TAVOLINO *COFFEE TABLE*  
281 - GF0669  
(L92 x P54 x H47 cm)

Struttura in alluminio,  
rivestimento in piattina di polietilene

*Aluminum frame,  
polyethylene strap covering*



W



N



M



□ ANGOLO *CORNER*  
572 - CS0109CR  
(L70 x P70 x H67 cm)



□ POLTRONA S/B *CHAIR W/A*  
573 - CS0109M  
(L60 x P70 x H67 cm)



□ POGGIPIEDI *OTTOMAN*  
574 - CS0109MS  
(L70 x P70 x H29 cm)



□ TAVOLINO *COFFEE TABLE*  
575 - CS0109T  
(L70 x P70 x H29 cm)



W

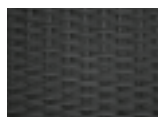

N



M

Struttura in alluminio,  
rivestimento in piattina di polietilene  
*Aluminum frame,  
polyethylene strap covering*

NEW



1636 - E71

Struttura in alluminio verniciato, rivestimento in piattina di polietilene  
*Aluminum frame powder coating, polyethylene strap covering*

H A H H   
76cm 49cm 45cm 45cm

   
N T



1637 - E72

Struttura in alluminio verniciato, seduta in textilene,  
schienale in corda di polietilene  
*Aluminum frame powder coating, textilene seat,  
polyethylene cord backrest*

H A H H   
76cm 49cm 45cm 45cm

NEW



1635 - E70

Struttura in alluminio verniciato, rivestimento in  
piattina di polietilene, cuscino idrorepellente

*Aluminum frame powder coating, polyethylene strap  
covering, waterproof cushion*



89cm 47cm 47cm 47cm



N T

NEW



1641 - SU8A

Struttura in alluminio verniciato, seduta e schienale in textilene

*Aluminum frame, powder coating, seat and backrest in textilene*



struttura / frame



1640 - SU8

Struttura in alluminio verniciato, seduta e schienale in textilene

*Aluminum frame, powder coating, seat and backrest in textilene*



struttura / frame



NEW



1631 - CH51

Struttura in alluminio verniciato,  
rivestimento e cuscino in textilene

*Aluminum frame powder coating,  
textylene covering and cushion*

h A h h  
84cm 47cm 48cm 48cm

struttura / frame

□ ■  
W T

tessuto / fabric



LG

DG

T

NEW



1607 - MB3

Struttura in alluminio verniciato,  
rivestimento e cuscino in textilene e olifem

*Aluminum frame powder coating,  
textylene with olifem covering and cushion*

h A h h  
88cm 58cm 51cm 43cm

tessuto / fabric



LG

G

M



NEW



1606 - MB4

Struttura in alluminio verniciato,  
rivestimento e cuscino in textilene e olifem

*Aluminum frame powder coating,  
textylene with olifem covering and cushion*

h A h h  
77cm 49cm 47cm 45cm

tessuto / fabric



LG



G



M



051 - MC1415

Struttura pieghevole in alluminio verniciato,  
braccioli in legno, tessuto in textilene

*Folding aluminum frame, powder coating,  
wood arms, textilene fabric*

h A h h  
91cm 43cm 44cm 47cm

□ ■ ■  
W V G



899 - HA30

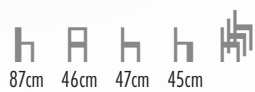

894 - HA50





906 - HA38  
(L80 x P80 x H76 cm) KD

907 - HA39  
(L180 x P90 x H76 cm) KD

Struttura in alluminio satinato,  
piano in materiale composito  
*Brushed aluminum frame,  
top in composite material*



SGABELLO *BAR STOOL*  
897 - HA93  
Struttura in alluminio satinato,  
seduta e schienale in materiale composito  
*Brushed aluminum frame,  
seat and backrest in composite material*

  
112cm 41cm 43cm 76cm KD

TAVOLO *TABLE*  
905 - HA37  
Struttura in alluminio satinato,  
piano in materiale composito  
*Brushed aluminum frame  
top in composite material*  
(L70 x P70 x H110 cm) KD



□ PANCA BENCH  
1117 - HM04B  
(L165 x P41 x H46 cm) KD



□ TAVOLO TABLE  
907 - HA39  
(L180 x P90 x H76 cm) KD

Struttura in alluminio satinato,  
piano in materiale composito  
*Satin aluminum frame,  
top and seat in composite material*

NEW



1581 - MC039

Struttura in alluminio verniciato

*Aluminum frame, powder coating*







1493 - QF16

Struttura in metallo verniciato

*Metal frame, powder coating*



78,5cm 44cm 41cm 46cm



W N G

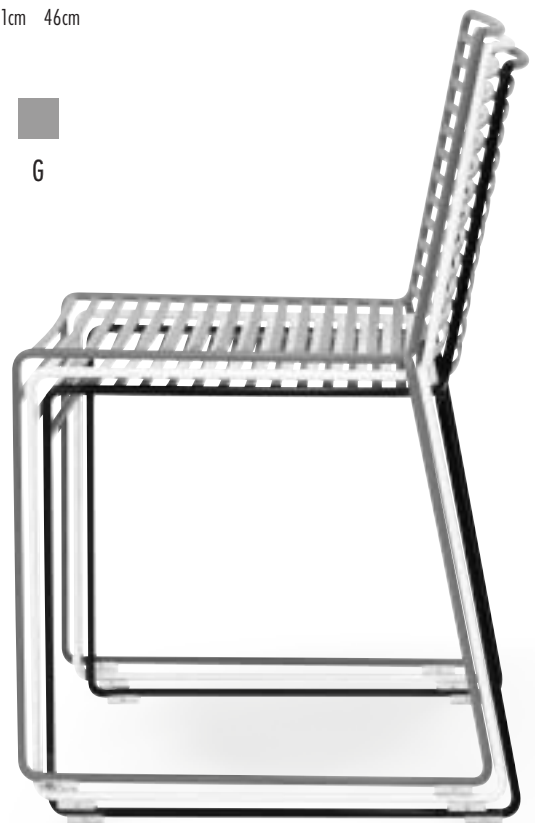



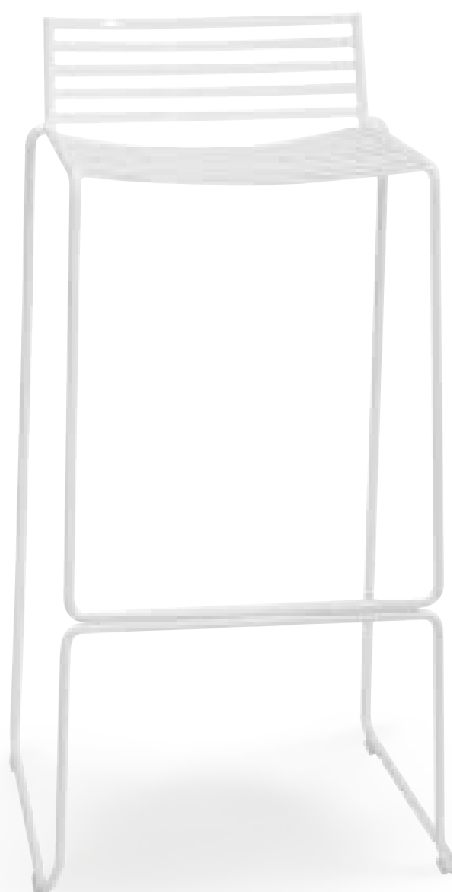
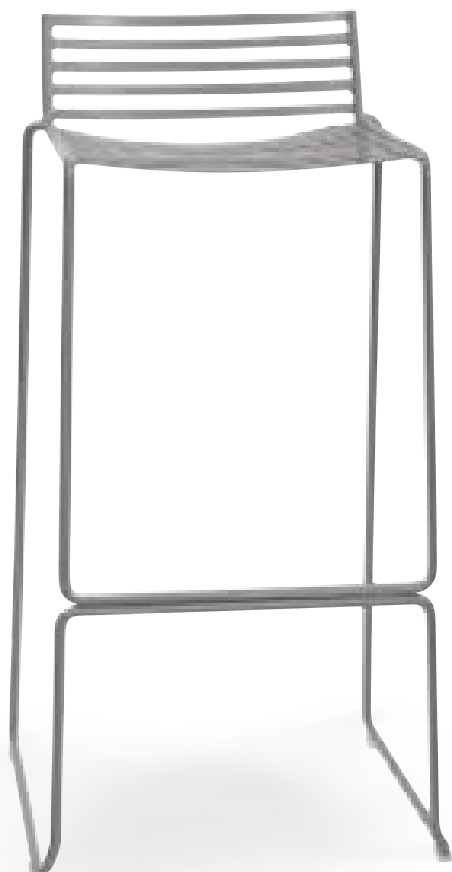

1498 - QF17

Struttura in metallo verniciato

*Metal frame, powder coating*

86,5cm 37cm 33cm 74cm

W N G



809 - C78

Struttura in metallo verniciato

*Metal frame, powder coating*



90cm 42cm 48cm 44,5cm



810 - C78A

Struttura in metallo verniciato

*Metal frame, powder coating*



90cm 42cm 48cm 44,5cm



996 - C22

Struttura in metallo verniciato

*Metal frame, powder coating*



90cm 45cm 44cm 45cm



128 - MA01A (Ø60 x H72 cm) KD  
129 - MA01B (Ø70 x H72 cm) KD



Struttura in metallo verniciato  
*Metal frame, powder coating*

130 - MA09A (70 x 70 x H72 cm) KD  
131 - MA09B (80 x 80 x H72 cm) KD



1526 - HY18 (70 x 70 x 74 cm)  
1508 - HY17 (80 x 80 x 74 cm)



Struttura in metallo verniciato  
*Metal frame, powder coating*



NEW

I T O<sup>®</sup>  
ITALIAN ORIGINAL



1568 - QT60  
L60 x P60 x H75 cm

1569 - QT70  
L70 x P70 x H75 cm

1570 - QT80  
L80 x P80 x H75 cm

1695 - HQT60  
L60 x P60 x H110 cm

1696 - HQT70  
L70 x P70 x H110 cm

Struttura in metallo verniciato  
*Metal frame, powder coating*



SET 1697 - VEC1  
Tavolo + 4 sgabelli / *Table + 4 barstools*

TAVOLO *TABLE*  
L75 x P75 x H110 cm

SGABELLO  
  
77cm 32cm 32cm



1670 - UEOW

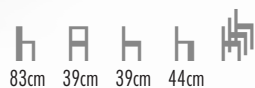

1699 - UE03

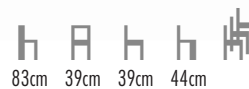

1698 - UE02



Struttura in metallo verniciato  
Metal frame, powder coating





□ DIVANO SOFA

1672 - BA02

Struttura in metallo verniciato, cuscino in ecopelle

*Metal frame, powder coating, PU cushion*

(L125 x P50 x H85 cm)

□ TAVOLINO COFFEE TABLE

1671 - BA03

Struttura in metallo verniciato, piano in HPL

*Metal frame, powder coating, HPL top*

(Ø 75 x H44 cm)



1670 - BA01

Struttura in metallo verniciato, cuscino in ecopelle

*Metal frame, powder coating, PU cushion*

h A h h  
79cm 55cm 42cm 47cm



1669 - BA22

Struttura in metallo verniciato, cuscino in ecopelle

*Metal frame, powder coating, PU cushion*

h A h h  
96cm 47cm 39cm 68cm



SET 1181 - CA43A

Struttura pieghevole in metallo verniciato

*Folding metal frame, powder coating*

□ TAVOLO TABLE  
(Ø 60 x H71 cm)

□ SEDIA CHAIR

h A h h  
80cm 41cm 46cm 45cm



SET 1297 - CF60

Struttura pieghevole in metallo verniciato e materiale composito

*Folding metal frame and composite material*

□ TAVOLO TABLE  
(Ø 60 x H71 cm)

□ SEDIA CHAIR

h A h h  
80cm 41cm 46cm 45cm



1242 - CH1

Struttura in metallo verniciato, rivestimento in filo di polietilene

*Metal frame, powder coating, polyethylene thread covering*









Designed by Claudio Francesco Bellini



□ SEDIA CHAIR  
1189 - T12

Struttura in polipropilene / Polypropylene frame

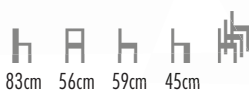

83cm 56cm 59cm 45cm



W N R A S G V DB B





725 - Y19

Struttura in polipropilene  
con fibra di vetro

*Polypropylene frame with  
fiberglass*

h A h h   
79cm 46cm 45cm 46,5cm







1480 - XH3

Struttura in polipropilene

*Polypropylene frame*

h A h h  
77,5cm 43,5cm 40cm 46cm







1477 - XH8

Struttura in polipropilene

*Polypropylene frame*







NEW



1689 - TG1



1690 - TG2



Struttura in polipropilene  
*Polypropylene frame*



1691 - TG3

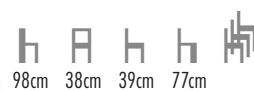



1089 - CT619

Struttura in polipropilene

*Polypropylene frame and shell*



81cm 44cm 41cm 45cm



W N G





1475 - 9A

Struttura in polipropilene con fibra di vetro

*Polipropylene frame with fiber glass*

h A h h h  
77cm 43,5cm 41,5cm 44cm

W N R V G SE T





1474 - 9C

Struttura in polipropilene con fibra di vetro

*Polipropylene frame with fiber glass*

h A h h h  
77cm 43,5cm 41,5cm 44cm

W N R V G SE T





1476 - 9B

Struttura in polipropilene con fibra di vetro

*Polipropylene frame with fiber glass*



96cm 36cm 34cm 75,5cm









1501 - 9D

Struttura in polipropilene con fibra di vetro

*Polipropylene frame with fiber glass*



78,5cm 40cm 42cm 47cm







1502 - 9E

Struttura in polipropilene con fibra di vetro

*Polipropylene frame with fiber glass*

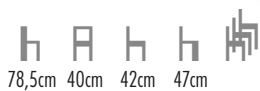





1503 - 9F

Struttura in polipropilene con fibra di vetro

*Polipropylene frame with fiber glass*



98cm 34,5cm 35cm 75cm







1152 - M44

Struttura in polipropilene

*Polypropylene frame*

h A h h  
80cm 41cm 46cm 45cm







1151 - M42  
Struttura in polipropilene  
*Polypropylene frame*

h A h h  
94cm 39cm 40cm 64cm





1298 - M18

Struttura in polipropilene

*Polypropylene frame*

h A h h   
77cm 44cm 46cm 45cm

     
W N G P



998 - SH15  
 Struttura in polipropilene  
*Polypropylene frame*





818 - U12

Struttura in polipropilene

*Polypropylene frame*



W

N

M

J



819 - U13  
Struttura in polipropilene  
*Polypropylene frame*



W

N

M

J



□ SEDIA CHAIR  
1054 - LIB  
Struttura in polipropilene  
*Polypropylene frame*

  
 80cm 45cm 51cm 45cm



  
 W N A LV G BO BE





□ POLTRONCINA *ARMCHAIR*  
1156 - WAM

Struttura in polipropilene  
*frame*









1483 - A11  
Struttura in polipropilene  
*Polypropylene frame*

h A h h   
88cm 45cm 42,5cm 46cm

      
W N G M PE



1300 - M40

Struttura e piano in polipropilene

*Polypropylene frame and top*  
(L70 x P70 x H74 cm)





883 - 180P

Struttura in polipropilene  
con fibra di vetro

*Polypropylene frame  
with fiberglass*

h A h h h  
83cm 40cm 40cm 44,5cm

W N R V



1269 - OW139

Struttura in polipropilene

*Polypropylene frame*



76cm 47cm 40cm 45,5cm



W N A G



1277 - M25

Struttura in polipropilene

*Polypropylene frame*



87cm 40,5cm 42cm 45cm



802 - Y012

Struttura in polipropilene  
con fibra di vetro

*Polypropylene frame with  
fiberglass*

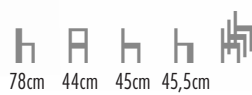

78cm 44cm 45cm 45,5cm



W V

NEW



1141 - 48L

Struttura in polipropilene

*Polipropilene frame*

h A h h   
81cm 39cm 47cm 65cm

W R

NEW



1579 - TJE

Gambe in alluminio,  
scocca in polipropilene

*Aluminum legs,  
polypropylene shell*

h A h h H  
82cm 40cm 41cm 45cm

W N R G V



NEW



1580 - TVL

Gambe in alluminio,  
scocca in polipropilene

*Aluminum legs,  
polypropylene shell*

82cm 48cm 41cm 45cm

W N R G V



690 - PP

Gambe in alluminio,  
scocca in polipropilene

*Aluminum legs,  
polypropylene shell*



82cm 44cm 41cm 44cm





691 - PL

Gambe in alluminio,  
scocca in polipropilene

*Aluminum legs,  
polypropylene shell*



75cm 51cm 41cm 44cm





807 - TIB

Struttura in alluminio, *Aluminum legs,*  
 piano in polipropilene *polypropylene table top*

(L75 x P75 x H75 cm)



921 - A75

Struttura in alluminio, *Aluminum legs,*  
 piano in polipropilene *polypropylene table top*

(P75 x L75 x H75 cm)

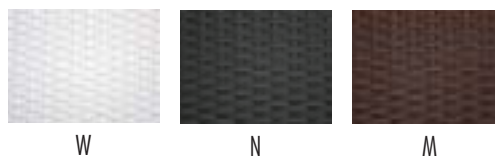

1044 - S15

Struttura in polipropilene  
*Polypropylene frame*  
 (L78,5 x P78,5 x H75,5 cm)

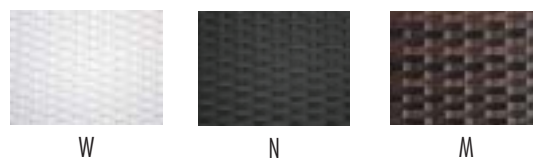



1145 - 047

Struttura in polipropilene

*Polypropylene frame*



81cm 50cm 62cm 45cm



R V



1161 - E80

88cm 39cm 42cm 44,5cm

Struttura in alluminio verniciato bambù,  
tessuto in textilene

*Painted aluminum frame, bamboo look,  
textylene fabric covering*



1162 - E80A

88cm 39cm 42cm 44,5cm



062 - AM10

89cm 39cm 42cm 44,5cm

Struttura in alluminio verniciato bambù,  
rivestimento in piattina di nylon

*Aluminum frame, bamboo look,  
nylon strap covering*



063 - AM09

89cm 39cm 42cm 44,5cm



060 - AM03

Struttura in alluminio verniciato bambù,  
tessuto in textilene

*Aluminum frame, bamboo look,  
textylene fabric covering*

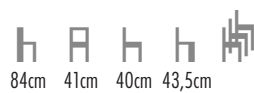

84cm 41cm 40cm 43,5cm



056 - AM02

Struttura in alluminio verniciato bambù,  
tessuto in textilene

*Aluminum frame, bamboo look,  
textylene fabric covering*



88cm 39cm 42cm 44,5cm



055 - AM01

Struttura in alluminio verniciato bambù,  
tessuto in textilene

*Aluminum frame, bamboo look,  
textylene fabric covering*

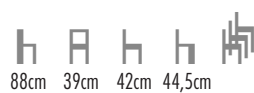

88cm 39cm 42cm 44,5cm



718 - MCR138

Struttura in alluminio verniciato,  
seduta e schienale in piattina di polietilene

*Aluminum frame, polyethylene  
strap covering*



91cm 41cm 41cm 46cm



719 - MCR139

Struttura in alluminio verniciato,  
seduta e schienale in piattina di polietilene

*Aluminum frame, polyethylene  
strap covering*



91cm 45cm 41cm 46cm





472 - P77

Struttura in alluminio, rivestimento  
in piattina di polietilene

*Aluminum frame, polyethylene  
strap covering*



89cm 37cm 45cm 46cm



473 - P78

Struttura in alluminio, rivestimento  
in piattina di polietilene

*Aluminum frame, polyethylene  
strap covering*



89cm 45cm 45cm 46cm



015 - ALR92

Struttura in alluminio, rivestimento  
in piattina di polietilene

*Aluminum frame, polyethylene  
strap covering*



91cm 41cm 39,5cm 47cm



W



N



016 - ALR95

Struttura in alluminio, rivestimento  
in piattina di polietilene

*Aluminum frame, polyethylene  
strap covering*

h A h h H  
91cm 41cm 39,5cm 47cm



946 - 38A

Struttura in alluminio, rivestimento  
in piattina di polietilene

*Aluminum frame, polyethylene  
strap covering*

h A h h   
85cm 44cm 44cm 45,5cm



W



N

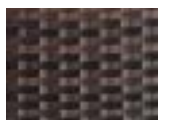

M



947 - 39A

Struttura in alluminio, rivestimento  
in piattina di polietilene

*Aluminum frame, polyethylene  
strap covering*

  
 85cm 47cm 43cm 45,5cm



W

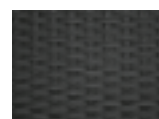

N



M



498 - L80801

Struttura in alluminio, rivestimento  
in piattina di polietilene

*Aluminum frame, polyethylene  
strap covering*



86cm 41cm 43cm 46cm



W

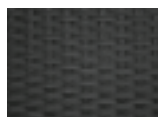

N



M



499 - L80804

Struttura in alluminio, rivestimento  
in piattina di polietilene

*Aluminum frame, polyethylene  
strap covering*

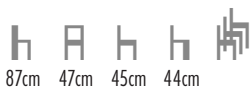

87cm 47cm 45cm 44cm



W

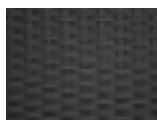

N



M



560 - CTS0022  
(L70 x P70 x H75 cm) KD

Struttura in alluminio, rivestimento in piattina di polietilene, piano in vetro temperato, base in alluminio

*Aluminum frame, polyethylene strap covering, tempered glass top, aluminum base*



W

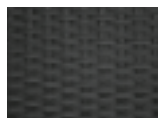

N

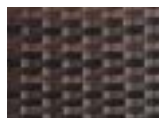

M



561 - MCQ 80 (L80 x P80 x H75 cm) KD  
562 - MCQ 90 (L90 x P90 x H75 cm) KD  
563 - MCQ 140 (L140 x P80 x H75 cm) KD

Struttura in alluminio, rivestimento in piattina di polietilene, piano in vetro temperato

*Aluminum frame, polyethylene strap covering, tempered glass top*



W

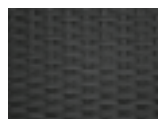

N



M





□ SGABELLO BAR STOOL  
548 - CBC0001

Struttura in alluminio, rivestimento in  
piattina di polietilene

*Aluminum frame, polyethylene strap  
covering*

h A h h  
107cm 43cm 55cm 76cm



□ TAVOLO TABLE  
565 - CBT0002

Struttura in alluminio, rivestimento in piattina di polietilene,  
base in alluminio, piano in vetro temperato

*Aluminum frame, polyethylene strap covering,  
aluminum base, tempered glass top  
(P80 x L80 x H110 cm) KD*



W



N



M



547 - 0624G

Struttura in alluminio, rivestimento in piattina di polietilene

*Aluminum frame, polyethylene strap covering*

76cm 33cm



W



N

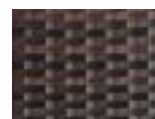

M



943 - CBC0004

Struttura in alluminio, rivestimento in piattina di polietilene

*Aluminum frame, polyethylene strap covering*

105cm 40cm 40cm 76cm



W

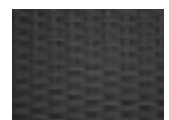

N

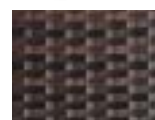

M



SET 566 - 0624T

- Tavolo + 4 sgabelli / Table + 4 bar stools  
 Struttura in alluminio, rivestimento in piattina di polietilene, piano in vetro temperato  
*Aluminum frame, polyethylene strap covering, tempered glass top*  
 (L77 x P77 x H110 cm)



W



N



M



796 - CSL8

Struttura anatomica in alluminio,  
rivestimento in piattina di polietilene

*Anatomical aluminum frame,  
polyethylene strap covering*

(L200 x P63 cm)



W



N

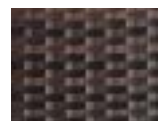

M



1130 - CS21

Struttura in alluminio,  
rivestimento in piattina di polietilene

*Aluminum frame,  
polyethylene strap covering*

(L193 x P64 x H62 cm)



W



N

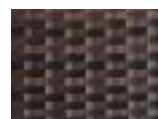

M



1554 - A12

Struttura in alluminio verniciato, rivestimento in textilene

*Aluminum frame, powder coating, textilene covering*

(L194 x P67 cm)





1053 - SUN

Struttura in polipropilene con ruote posteriori,  
tessuto in textilene

*Polypropylene frame with back wheels,  
textylene fabric*

(L193 x P57 x H29 cm) 

Tessuto / fabric

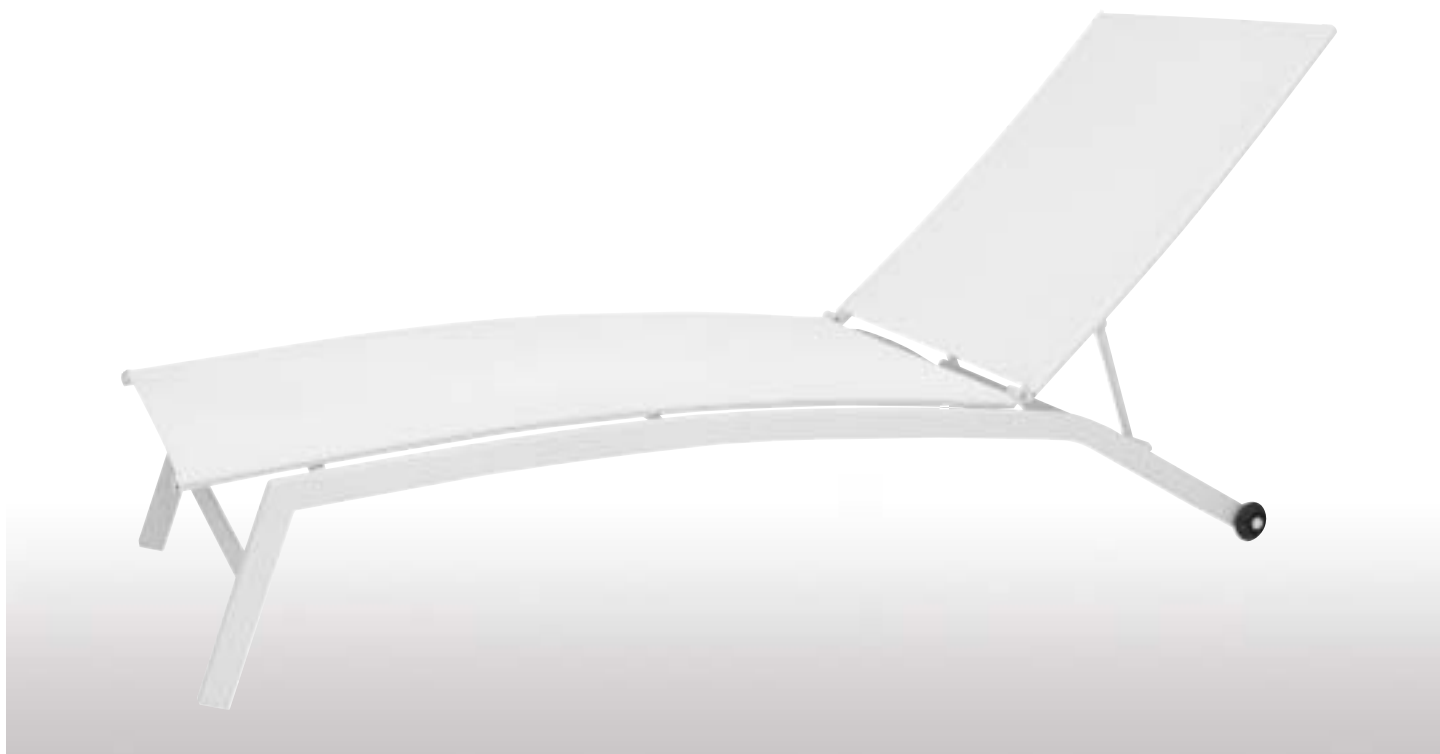

1546 - JY6F

Struttura in metallo verniciato rivestimento in textilene

*Metal frame, powder coating, textylene covering*  
(L194 x P59 cm) KD

NEW



1671 - TE1

Struttura in polipropilene  
*Polypropylene frame*  
 (L45 x P45 x H45 cm)



1555 - T12

Struttura in alluminio verniciato  
*Aluminum frame, powder coating*  
 (L40 x P40 x H33 cm)



1557 - T13

Struttura in alluminio verniciato  
*Aluminum frame, powder coating*  
 (Ø45 x H33 cm)





020 - ALR12

Struttura in alluminio anodizzato e saldato, Ø 25 x 1,5 mm, seduta e schienale in filo di polietilene

*Anodized aluminum, welded frame, tube Ø 25 x 1,5 mm, polyethylene thread covering*

h A h h   
77 cm 41cm 44cm 44cm

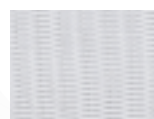

W



N



P





024 - ALR04

Struttura in alluminio anodizzato, filo in polietilene

*Anodized aluminum frame, polyethylene thread covering*

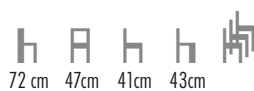

W

N



026 - ALR06

Struttura in alluminio anodizzato e saldato, Ø 25 x 1,5 mm, seduta e schienale in filo di polietilene

*Anodized aluminum frame, tube Ø 25 x 1,5 mm, polyethylene thread covering*

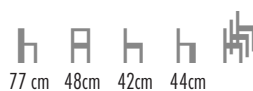

G

P



035 - ALW01  
 Struttura in alluminio anodizzato,  
 Ø 25 x 1,5 mm,  
 doghe in legno di rovere  
*Anodized aluminum frame,  
 tube Ø 25 x 1,5 mm, oak bands*



037 - ALW04  
 Struttura in alluminio anodizzato,  
 doghe in legno di rovere  
*Anodized aluminum frame,  
 oak bands*

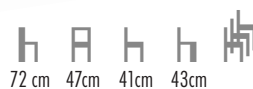

043 - ALW12  
 Struttura in alluminio anodizzato e saldato, Ø 25 x 1,5 mm, doghe in legno di rovere  
*Anodized aluminum welded frame, tube Ø 25 x 1,5 mm, oak bands*

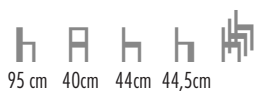

039 - ALW06  
 Struttura in alluminio  
 anodizzato e saldato,  
 Ø 25 x 1,5 mm,  
 doghe in legno di rovere  
*Anodized aluminum welded frame,  
 tube Ø 25 x 1,5 mm, oak bands*





038 - ALW05  
 Struttura in alluminio anodizzato  
 Ø 25 x 1,5 mm,  
 doghe in legno di rovere  
*Anodized aluminum frame,  
 tube Ø 25 x 1,5 mm, oak bands*



040 - ALW07  
 Struttura in alluminio anodizzato  
 Ø 25 x 1,5 mm,  
 doghe in legno di rovere  
*Anodized aluminum frame,  
 tube Ø 25 x 1,5 mm, oak bands*

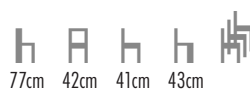

042 - ALW09  
 Struttura in alluminio anodizzato  
 Ø 28 x 1,8 mm,  
 doghe in legno di rovere  
*Anodized aluminum frame,  
 tube Ø 28 x 1,8 mm, oak bands*



041 - ALW08  
 Struttura in alluminio anodizzato  
 Ø 28 x 1,8 mm,  
 doghe in legno di rovere  
*Anodized aluminum frame,  
 tube Ø 28 x 1,8 mm, oak bands*





109 - MTW006A (60 x 60 cm)  
110 - MTW006B (70 x 70 cm)  
111 - MTW006C (80 x 80 cm)



106 - MTW001 (Ø 60 cm)  
107 - MTW007A (Ø 70 cm)  
108 - MTW007B (Ø 80 cm)



675 - MTW013A (60 x 60 cm)  
676 - MTW013B (70 x 70 cm)  
677 - MTW013C (80 x 80 cm)



678 - MTW011A (Ø 60 cm)  
679 - MTW011B (Ø 70 cm)



001 - ALL01  
 Struttura in alluminio anodizzato  
 Ø 25 x 1,5 mm  
*Anodized aluminum frame,  
 tube Ø 25 x 1,5 mm*



004 - ALL04  
 Struttura in alluminio anodizzato  
*Anodized aluminum frame*

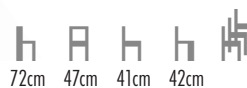

005 - ALL05  
 Struttura in alluminio anodizzato  
 Ø 25 x 1,5 mm  
*Anodized aluminum frame,  
 tube Ø 25 x 1,5 mm*

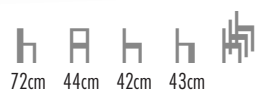

006 - ALL06  
 Struttura in alluminio anodizzato e saldato  
 Ø 25 x 1,5 mm  
*Anodized aluminum  
 welded frame,  
 tube Ø 25 x 1,5 mm*





454 - ALL33

Struttura in alluminio  
anodizzato e saldato Ø 25 x 1,5 mm

*Anodized aluminum  
welded frame, tube Ø 25 x 1,5 mm*

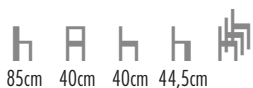

007 - ALL07

Struttura in alluminio  
anodizzato Ø 25 x 1,5 mm

*Anodized aluminum  
frame, tube Ø 25 x 1,5 mm*



010 - ALL09

Struttura in alluminio anodizzato  
Ø 28 x 1,8 mm

*Anodized aluminum frame,  
tube Ø 28 x 1,8 mm*



011 - ALL08

Struttura in alluminio anodizzato  
Ø 28 x 1,8 mm

*Anodized aluminum frame,  
tube Ø 28 x 1,8 mm*





091 - MTA006 (60 x 60 cm)



089 - MTA002 (Ø 60 cm)

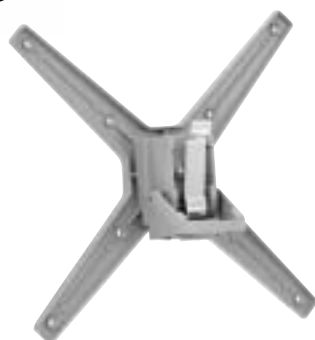

139 - M  
Accessorio pieghevole  
per tutti i tipi di tavoli  
con tubo centrale

*Folding system  
for all the tables  
with central tube*



090 - MTA005 (60 x 60 cm)



088 - MTA001 (Ø 60 cm)



097 - MTA013A (60 x 60 cm)  
098 - MTA013B (70 x 70 cm)  
099 - MTA013C (80 x 80 cm)  
717 - MTA013EK (120 x 80 cm)



100 - MTA011A (Ø 60 cm)  
101 - MTA011B (Ø 70 cm)



093 - MTA007A (70 x 70 cm)  
094 - MTA007B (80 x 80 cm)  
943 - MTA014CK (120 x 80 cm)



092 - MTA003A (Ø 70 cm)  
261 - MTA003B (Ø 80 cm)





096 - MTA010 (Ø 60 cm)



102 - MTA016K (Ø 60 cm)



095 - MTA009 (Ø 60 cm)



**Esterno**

***Outdoor***



**Interno**

***Indoor***



976 - ET53

Struttura in metallo verniciato

*Metal frame, powder coating*

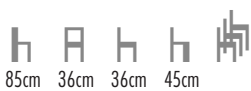



1084 - BT18

Struttura in metallo verniciato

*Metal frame, powder coating*

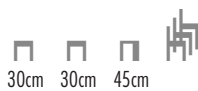



□ SEDIA CHAIR

978 - EM35W

Struttura in metallo verniciato,  
seduta in legno

*Metal frame, powder coating,  
wood seat*

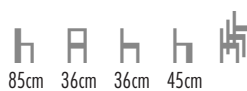

□ TAVOLO TABLE

1265 - 70W

(L70 x P70 x H74 cm)

972 - 36W

(L80 x P80 x H74 cm)

1418 - CT120

(L120 x P80 x H74 cm)

Struttura in metallo verniciato,

*Metal frame, powder coating*



NEW



1649 - 80WA

Struttura in metallo verniciato,  
piano in legno d'olmo

*Metal frame, powder coating,  
elmwood top*

(L80 x P80 x H75 cm) KD



955 - MC012

h A h h  
98,5cm 30cm 30cm 76cm



1083 - MC012W

h A h h  
98,5cm 30cm 30cm 76cm



977 - BT503

h A h h  
30cm 30cm 76cm



1082 - BT503W

h A h h  
30cm 30cm 76cm

Struttura in metallo verniciato / Metal frame, powder coating

Struttura in metallo verniciato, seduta in legno  
Metal frame, powder coating, wood seat





1266 - CT60

Struttura in metallo verniciato

*Metal frame, powder coating*

(L60 x P60 x H105 cm)





1100 - M51

Struttura in metallo verniciato, effetto anticato  
*Metal frame powder coating, antique look*



NEW



1575 - 36WA

Struttura in metallo verniciato,  
effetto anticato

*Metal frame, powder coating,  
antique look*

(L80 x P80 x H75 cm) KD



1295 - BT03

Struttura in metallo verniciato,  
effetto anticato

*Metal frame, powder coating,  
antique look*

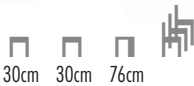

30cm 30cm 76cm



W N R Y





1073 - MC012PZ

h A h h  
98cm 30cm 30cm 76cm

Struttura in metallo zincato  
e vernice trasparente  
*Galvanized metal frame  
and varnish*



1071 - M012Z

h h h h  
30cm 30cm 30cm 76cm



971 - MC001B

h A h h h  
85cm 36cm 36cm 45cm



□ SEDIA CHAIR  
969 - MC001T

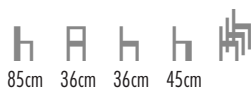

□ TAVOLO TABLE  
1262 - 236D  
(L80 x P80 x H76 cm) KD

Struttura in metallo verniciato  
con vernice trasparente  
*Metal frame, powder coating with varnish*

1066 - MC001TW  
Struttura in metallo verniciato  
con vernice trasparente, seduta in legno  
*Metal frame, powder coating  
with varnish, wood seat*

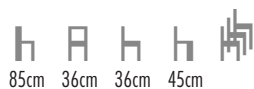



966 - MC012T



1060 - MC012PT



1264 - 010T

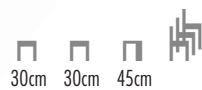

Struttura in metallo verniciato con vernice trasparente  
*Metal frame, powder coating with varnish*



1068 - MC012PTW

Struttura in metallo verniciato con vernice trasparente, seduta in legno

*Metal frame, powder coating with varnish, wood seat*



  
 98cm 30cm 30cm 76cm



1267 - GT24

Struttura in metallo verniciato con vernice trasparente

*Metalframe, powder coating with varnish*

(L65 x P65 x H107 cm) KD



1067 - MC012TW

Struttura in metallo verniciato con vernice trasparente, seduta in legno

*Metal frame, powder coating with varnish, wood seat*



  
 30cm 30cm 76cm





1427 - 01N

Struttura in metallo verniciato, effetto canna di fucile

*Metal frame, powder coating, gun look*

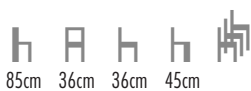

85cm 36cm 36cm 45cm



1428 - 01NW

Struttura in metallo verniciato, effetto canna di fucile, seduta in legno

*Metal frame, powder coating, gun look, wood seat*



85cm 36cm 36cm 45cm



1496 - BT04

Struttura in metallo verniciato, effetto canna di fucile

*Metal frame, powder coating, gun look*

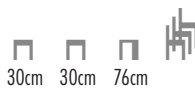

30cm 30cm 76cm



SEDIA CHAIR  
968 - MC001D

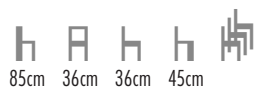

TAVOLO TABLE  
956 - 36D  
(L82 x P82 x H76 cm)

Struttura in metallo verniciato, effetto anticato  
*Metal frame, brush painting, antique look*



CUSCINO PAD  
1275 - PAD1

1077 - MC001DW  
Struttura in metallo verniciato,  
effetto anticato, seduta in legno  
*Metal frame, brush painting,  
antique look, wood seat*

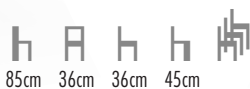



1061 - MC012D



1062 - MC012DT



1263 - 009T

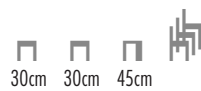

Struttura in metallo verniciato effetto anticato  
*Metal frame, brush painting, antique look*



1079 - MC012DTW

Struttura in metallo verniciato effetto anticato, seduta in legno  
*Metal frame, brush painting, antique look, wood seat*

h A h h  
98cm 30cm 30cm 76cm



1268 - GT28

Struttura in metallo verniciato  
effetto anticato

*Metal frame, brush painting,  
antique look*

(L65 x P65 x H107 cm) KD



1078 - MC012DW

Struttura in metallo verniciato  
effetto anticato, seduta in legno

*Metal frame, brush painting,  
antique look, wood seat*

h h h h  
30cm 30cm 76cm



1417 - BM37

Struttura in metallo verniciato,  
effetto anticato, seduta in legno

*Metal frame powder coating,  
antique look, wood seat*

□ □  
33cm 65/78cm



1495 - BC02

Struttura in metallo verniciato,  
effetto anticato, seduta in legno

*Metal frame powder coating,  
antique look, wood seat*

□ □  
30cm 63/81cm



1464 - 05A

Struttura in metallo verniciato

*Metal frame, powder coating*



72cm 36cm 36cm 44cm



W N R A V B G Y



1431 - MC001A

Struttura in metallo verniciato  
con vernice trasparente

*Metal frame, powder coating with varnish*

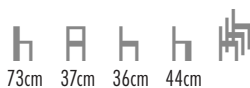

1432 - MC001AW

Struttura in metallo verniciato  
con vernice trasparente, seduta in legno

*Metal frame, powder coating with varnish,  
wood seat*

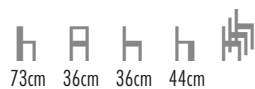

NEW



1661 - DA3

Struttura in metallo verniciato, rivestimento in velluto  
*Metal frame, powder covering, velvet covering*

h A h h  
84cm 44cm 44cm 47cm



1662 - DA4

Struttura in metallo cromato oro, rivestimento in velluto  
*Gold metal frame chromed, velvet covering*

h A h h  
84cm 44cm 44cm 47cm

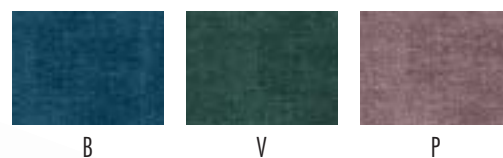



NEW



1652 - J02

Struttura in metallo cromato oro, rivestimento in velluto

*Gold metal frame chromed, velvet covering*

78cm 46cm 42cm 46cm



LG



DG



LB



DB



V



R

NEW



1638 - DH2

Struttura in legno di faggio

*Beeck wood frame*



77cm 41cm 42cm 46cm

legno / wood



N

NA



1186 - HT35  
 Struttura in legno  
 Wood frame



1440 - HT38  
 Struttura in legno  
 Wood frame





1188 - HT36

Struttura in legno, effetto anticato,  
seduta in rattan

*Wood frame, antique look,  
rattan seat*

h A h h  
89cm 50cm 54cm 45cm



1321 - HT37

Struttura in legno, effetto anticato,  
seduta in rattan

*Wood frame, antique look,  
rattan seat*

h A h h  
113cm 41cm 36,5cm 76cm



NAT

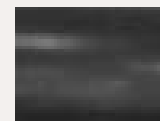

N



LM



NO



ST

NEW



NEW



□ SEDIA CHAIR  
1673 - PA1

Struttura in legno  
*Rubber wood frame*

89cm 44cm 43cm 44cm

legno / wood

NAT N/M

1674 - PA2

Struttura in legno  
*Rubber wood frame*

89cm 44cm 43cm 44cm

legno / wood

NAT N/M

NEW



□ SEDIA CHAIR  
1650 - PA3  
Struttura in legno  
*Rubber wood frame*

h A h h  
85cm 43cm 42cm 44cm

legno / wood



1692 - PA4  
Struttura in legno, seduta con cuscino  
*Rubber wood frame, seat with pad*

h A h h  
85cm 43cm 42cm 44cm

legno / wood



1042 - C25F

Struttura in legno,  
seduta imbottita

*Wood frame,  
seat with pad*

h A h h  
84cm 43cm 50cm 46cm



1041 - C25

Struttura in legno,  
seduta in legno

*Wood frame,  
wood seat*

h A h h  
84cm 43cm 50cm 46cm





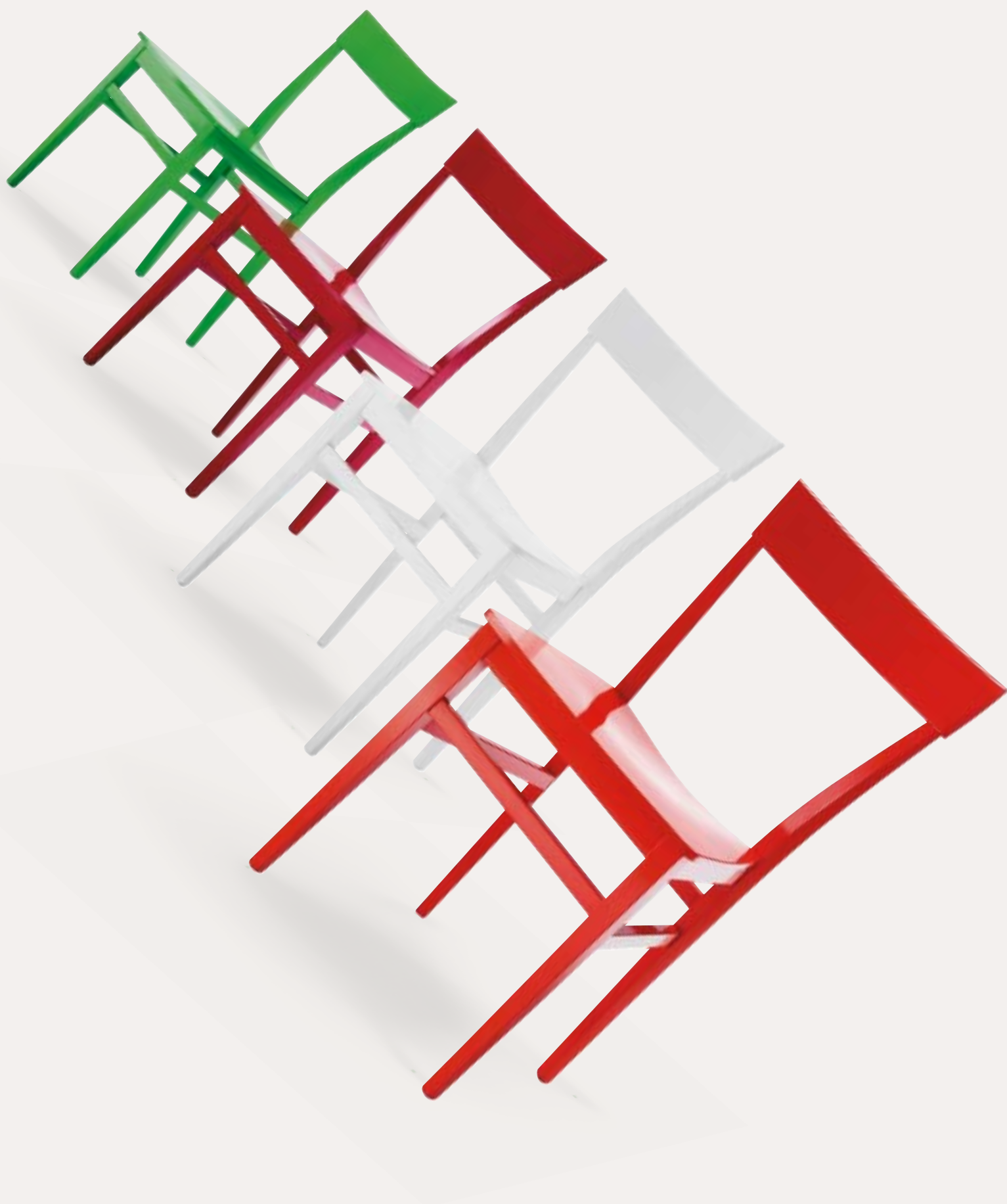



1124 - M07

Struttura in metallo verniciato,  
seduta e schienale in legno multistrato

*Metal frame, powder coating  
seat and backrest in plywood*

h A h h  
77cm 42cm 39cm 45cm

struttura / frame



W N



1036 - G02  
 Struttura in legno,  
 seduta in legno  
*Wood frame,  
 wood seat*

h A h h  
 87cm 42cm 39cm 46cm

W R M G





1037 - G03  
Struttura in legno,  
seduta impagliata  
*Wood frame,  
natural straw seat*

h A h h  
87cm 40cm 37cm 47cm

W R M G





1258 - G04L

Struttura in legno, seduta in legno / *Wood frame, wood seat*



h A h h  
102cm 40cm 37cm 73cm



1038 - G04

Struttura in legno, seduta impagliata / *Wood frame, straw seat*



h A h h  
102cm 40cm 37cm 73cm



1484 - AR7

Struttura in legno, seduta impagliata

Wood fram, straw seat



88cm 40cm 37cm 47cm





NEW



1585 - S37R

Struttura in legno di frassino,  
seduta impagliata

*Ash wood frame,  
natural straw seat*

h A h h  
78cm 44cm 43cm 45cm

NAT M



NEW



1584 - S37

h A h h   
81cm 44cm 42cm 46cm



1582 - S37A

h A h h   
79cm 48cm 47cm 46cm



1583 - S847

h A h h   
110cm 41cm 37cm 75cm

Struttura in metallo verniciato, seduta impagliata,  
schienale in multistrato

*Metal frame, powder coating, natural straw seat,  
plywood backrest*



1014 - JK5

Struttura in metallo cromato,  
seduta impagliata

*Chromed metal frame, straw seat*



84 cm 44cm 41cm 46cm



1015 - JK5B

Struttura in metallo cromato,  
seduta impagliata

*Chromed metal frame, straw seat*



100 cm 41cm 39cm 75cm

NEW



1683 - ST23

Struttura in legno di faggio, schienale in polipropilene  
*Beech wood frame, polypropylene backrest*

h A h h  
 67cm 45cm 41cm 47cm



1684 - ST23A

Struttura in legno di faggio, schienale in polipropilene, poggiapiedi in metallo  
*Beech wood frame, polypropylene backrest, metal footrest*

h A h h  
 99cm 45cm 37cm 76cm



1525 - D24

Struttura in polipropilene e metallo, gambe in legno di faggio

*Polypropylene and metal frame, beech wood legs*

h h h h  
75cm 41cm 42cm 45cm

W N LG V B





1322 - Z87

Gambe in legno,  
scocca in polipropilene

*Wood legs,  
polypropylene shell*



84cm 43cm 40cm 45cm





NEW



1593 - XH2P

Struttura in legno di faggio, scocca in polipropilene, cuscino in tessuto

*Beech wood frame, polypropylene frame, fabric pad*

h A h h  
80cm 39cm 40cm 45cm

W N R P T





1144 - 62F

Struttura in metallo e legno,  
scocca in polipropilene, cuscino in tessuto

*Metal and wood frame,  
polypropylene shell, fabric pad*

h A h h  
82cm 48cm 50cm 46cm

1320 - W2C

Struttura in legno, scocca in policarbonato,  
cuscino in tessuto

*Wood frame, polycarbonate shell,  
fabric pad*

h A h h  
81cm 49cm 58cm 46cm



1489 - YG99

Struttura in legno di faggio, rivestimento in ecopelle

*Beeck wood frame, polyurethane covering*

h A h h  
75cm 42cm 42cm 44cm

legno / wood



N



NA

ecopelle / polyurethane



N



M

NEW



1587 - YG101

Struttura in legno multistrato di faggio,  
rivestimento in ecopelle*Beech plywood frame, polyurethane covering*

77cm 46cm 42cm 44cm

ecopelle / polyurethane



V M

NEW



1586 - YG100

Struttura in legno multistrato di faggio,  
rivestimento in tessuto

*Beech plywood frame, fabric covering*

h A h h  
77cm 46cm 42cm 44cm



B



DG



LG



1492 - YG94

Struttura in legno di faggio, scocca in polipropilene,  
cuscino in ecopelle

*Beeck wood frame, polypropylene shell,  
polyurethane pad*

h A h h  
76cm 42cm 42cm 44cm



1423 - YM2

Struttura in legno di faggio, rivestimento in ecopelle  
*Beech wood frame, polyurethane covering*



  
 83cm 45cm 43cm 43cm

struttura / frame



ecopelle / PLI



1422 - YM1

Struttura in legno di faggio, rivestimento in ecopelle  
*Beech wood frame, polyurethane covering*



  
 76cm 46cm 43cm 44,5cm

struttura / frame



ecopelle / PLI



NEW



1626 - EV10

Struttura in legno di faggio con seduta girevole, scocca in polipropilene, cuscino in ecopelle

*Beech wood frame with shell function mechanism, polyurethane pad*

struttura / frame

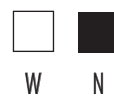



1682 - ST77

Gambe in legno di faggio, scocca in polipropilene,  
cuscino in ecopelle

*Beech wood legs, polypropylene shell,  
polyurethane pad*

h A h h  
78cm 43cm 39cm 47cm

□ ■  
W T





1438 - C50W

Struttura in metallo e legno, seduta e schienale in tessuto o ecopelle  
*Metal and wood frame, seat and backrest in fabric or polyurethane*

1439 - C50P

Struttura in metallo verniciato, seduta e schienale in tessuto o ecopelle  
*Metal frame, powder coating, seat and backrest in fabric or polyurethane*

h A h h  
 81cm 44cm 44cm 48cm

ecopelle / polyurethane  
  
 W N G DM

tessuto / fabric

  
 G DG DB



1335 - W58

Struttura in metallo e legno,  
rivestimento in tessuto o ecopelle

*Metal and wood frame,  
polyurethane or fabric covering*

h A h h  
85cm 57cm 51cm 47cm

ecopelle / polyurethane

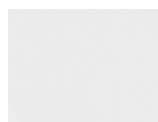

W



N

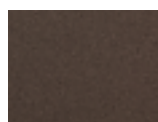

M

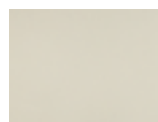

BE



G





1335 - W58

Struttura in metallo e legno,  
rivestimento in tessuto o ecopelle

*Metal and wood frame,  
polyurethane or fabric covering*



85cm 57cm 51cm 47cm

tessuto / fabric

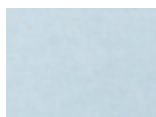





1334 - B91

Struttura in legno multistrato e legno massello, rivestimento in ecopelle

*Plywood frame and solid rubber wood, polyurethane covering*

  
79cm 51,5cm 51,5cm 46cm

*ecopelle / polyurethane*



A

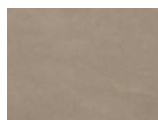

B

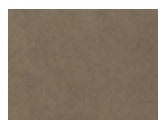

C

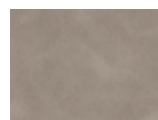

D

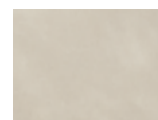

E





1524 - D22

Struttura in legno e metallo,  
rivestimento in tessuto

*Wood and metal frame,  
shell with fabric covering*

h A h h  
83cm 45cm 42cm 46cm

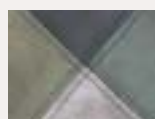

PK18



PK17



1523 - D23

Struttura in legno e metallo,  
rivestimento in tessuto

*Wood and metal frame,  
shell with fabric covering*

h A h h  
80cm 44cm 40cm 46cm



PK18

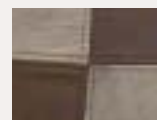

PK17



NEW





1185 - PW07

Struttura in legno e metallo,  
rivestimento in tessuto

*Wood and metal frame,  
shell with fabric covering*



  
 81cm 55cm 60cm 46cm

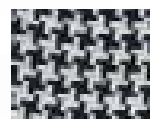

N

R

M

V

G

A

B

PAT

PAD





1150 - 72B

Struttura in legno,  
rivestimento in tessuto

*Wood frame, fabric shell*

h A h h  
81cm 49cm 58cm 46cm

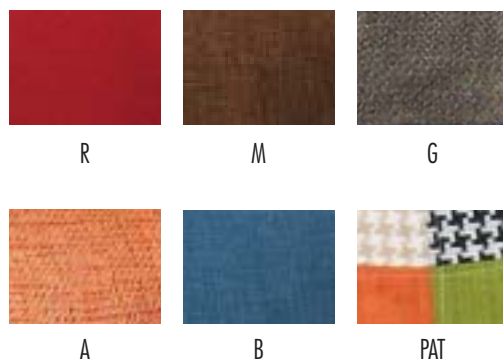



1193 - PW72

Struttura in legno, scocca in polipropilene, seduta in ecopelle  
*Wood frame, polypropylene shell, polyurethane pad*



  
 82cm 48cm 50cm 46cm







  
 W N R A G V Y



1148 - 72K

Struttura in metallo e legno,  
scocca in polipropilene, cuscino in ecopelle

*Metal and wood frame,  
polypropylene shell, polyurethane pad*

h A h h  
82cm 48cm 50cm 45cm

□ ■ ■ ■  
W N R G





1057 - PW022  
 Struttura in metallo e legno,  
 scocca in polipropilene  
*Wood and metal frame,  
 polypropylene shell*

h A h h  
 83cm 56cm 40cm 46cm

□ ■  
 W N



1092 - FL08W  
 Struttura in metallo e legno,  
 scocca in polipropilene  
*Metal and wood frame,  
 polypropylene shell*

h A h h  
 85,5cm 55cm 45cm 45cm

□ ■  
 W N





1143 - M2

Struttura in metallo e legno,  
seduta in polipropilene

*Metal and wood frame,  
polypropylene seat*

□ □ □  
47cm 35cm 47cm











1103 - NET08

Struttura in metallo e legno, scocca in polipropilene

*Woody and metal frame, polypropylene shell*



  
 80cm 42cm 40cm 45cm



  
 W N G



1419 - ITP3

h A h h  
76cm 47cm 50cm 48cm



1436 - ITP4

h A h h  
107cm 44cm 45cm 79cm

Struttura in legno, rivestimento in ecopelle  
Wood frame, polyurethane covering

legno / wood



ecopelle / polyurethane





926 - JY05

Struttura in legno, rivestimento in ecopelle

Wood frame, polyurethane covering

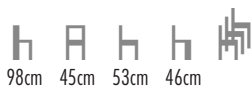

1035 - D060

Struttura in legno, rivestimento in ecopelle

Wood frame, polyurethane covering



924 - JY51

Struttura in legno, rivestimento in ecopelle

Wood frame, polyurethane covering

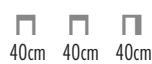



925 - JY08

Struttura in legno,  
rivestimento in ecopelle

*Wood frame,  
polyurethane covering*



101cm 41cm 51cm 77cm



W N M P



917 - JY11

Struttura in legno,  
rivestimento in ecopelle

*Wood frame,  
polyurethane covering*



75cm 40cm 40cm 75cm



W N M P



1451 - 7BD

Struttura in metallo, rivestimento in ecopelle

*Metal frame, polyurethane covering*

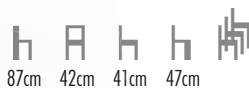

87cm 42cm 41cm 47cm



1456 - 30D

Struttura in metallo, rivestimento in ecopelle

*Metal frame, polyurethane covering*

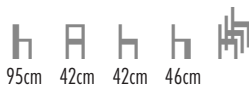

95cm 42cm 42cm 46cm

NEW



ecopelle / polyurethane



W

N

G

T

tessuto / fabric



LG

DG

BE

LM

Struttura in metallo verniciato,  
rivestimento in tessuto o ecopelle  
*Metal frame powder coating,  
fabric or polyurethane covering*

NEW



1616 - TOP9

h A h h  
74cm 58cm 52cm 40cm



1617 - TOP10

h A h h  
100cm 40cm 43cm 76cm



1615 - TOP8

h A h h  
83cm 41cm 46cm 47cm



1528 - T07

Struttura in metallo verniciato, rivestimento in ecopelle / *Metal frame powder coating, polyurethane covering*

h A h h  
82cm 45cm 45cm 48cm





NEW



1693 - F450

Struttura in metallo verniciato, rivestimento in tessuto  
*Metal frame powder coating, fabric covering*

h A h h  
 81cm 43cm 46cm 46cm

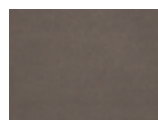

M

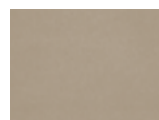

T



VI

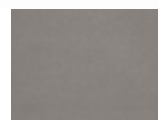

G



V

NEW



1601 - 82P

Struttura in metallo verniciato, rivestimento in ecopelle  
*Metal frame powder coating, PLI covering*

h A h h  
76cm 43cm 42cm 47cm



1602 - 82C

Struttura in metallo cromato, rivestimento in ecopelle  
*Chromed frame powder coating, PLI covering*

h A h h  
76cm 43cm 42cm 47cm



821 - RF49C

Struttura in metallo cromato,  
rivestimento in ecopelle

*Chromed metal frame,  
PVC covering*



90cm 41,5cm 41,5cm 46cm



W N M



825 - RF49P

Struttura in metallo verniciato,  
rivestimento in ecopelle

*Metal frame, powder  
coating, PVC covering*



90cm 41,5cm 41,5cm 46cm







1105 - RF91

Struttura in metallo verniciato, rivestimento in ecopelle

*Metal frame, powder coating, PVC covering*

h A h h  
90cm 41cm 41cm 46cm

W N R V



1020 - SS95  
 Struttura in metallo,  
 rivestimento in ecopelle  
*Metal frame*  
*polyurethane covering*

h A h h  
 80cm 61cm 52cm 47cm



NEW



1613 - TOP6

Struttura in metallo, rivestimento in pelle rigenerata  
*Metal frame, recycling leather covering*

h A h h  
76cm 44cm 43cm 45cm



NEW



1614 - TOP7

Struttura in metallo verniciato, rivestimento esterno in ecopelle, interno in tessuto

*Metal frame, powder coating, outside polyurethane covering, inside fabric covering*



76cm 43cm 42cm 47cm



1485 - F50

Struttura in metallo, rivestimento in ecopelle  
*Metal frame, polyurethane covering*



99cm 45cm 39cm 47cm





1482 - F442

Struttura in metallo, rivestimento in ecopelle / *Metal frame, polyurethane covering*

h A h h  
80cm 43cm 42cm 47cm



W N R G M T



949 - F400

Struttura in metallo,  
rivestimento in ecopelle

*Metal frame, polyurethane covering*



87cm 43cm 40cm 47,5cm





948 - F503

Struttura in metallo,  
rivestimento in ecopelle

*Metal frame, polyurethane covering*



96cm 43cm 40cm 47cm





824 - RF97

Struttura in metallo,  
rivestimento in ecopelle

*Metal frame,  
PVC covering*



96cm 45cm 45cm 46cm



W N R A V M G





837 - C4135

Struttura in metallo cromato,  
seduta e schienale in ecopelle

*Chromed metal frame,  
PVC seat and backrest*



83,5cm 40,5cm 41cm 46cm







608 - C2406

Struttura in metallo cromato,  
seduta e schienale in ecopelle

*Chromed metal frame,  
PVC seat and backrest*



79cm 51cm 56cm 45cm



W N





593 - C2842

Struttura in metallo cromato,  
seduta e schienale in ecopelle*Chromed metal frame,  
polyurethane seat and back*

85cm 45cm 53cm 46cm





1329 - CQ04

Struttura in metallo cromato,  
seduta e schienale in ecopelle  
*Chromed metal frame,  
polyurethane seat and backrest*



81cm 44cm 43cm 47cm



N R



1330 - CQ03

Struttura in metallo cromato,  
seduta e schienale in ecopelle  
*Chromed metal frame,  
polyurethane seat and backrest*



110cm 39cm 37cm 77cm



N R



1331 - CQ02

Struttura in metallo cromato, seduta e schienale in ecopelle  
*Chromed metal frame, polyurethane seat and backrest*



h A h h  
 83cm 101cm 44cm 45cm

■ ■  
 N R



1332 - CQ13

Struttura in metallo e legno, seduta e schienale in ecopelle  
*Metal and wood frame, polyurethane seat and backrest*



h A h h  
 96cm 126cm 45cm 45cm

■ ■  
 N R



1259 - M0120C

Struttura in policarbonato

*Polycarbonate frame*



95cm 41cm 45cm 46cm



T W N



888 - ISA  
Struttura in policarbonato  
*Polycarbonate frame*

h A h h   
85cm 41,5cm 43cm 47cm



889 - PC492  
Struttura in policarbonato  
*Polycarbonate frame*

h A h h   
85cm 37cm 38,5cm 48cm

NEW



1589 - YG103

Struttura in metallo cromato, scocca in polipropilene,  
cuscino in ecopelle

*Chromed metal frame, polypropylene shell,  
polyurethane pad*



76cm 42cm 42cm 45cm

scocca / shell



W N G





1486 - YG91

Struttura in metallo cromato, scocca in polipropilene,  
cuscino in ecopelle

*Chromed metal frame, polypropylene shell,  
polyurethane pad*



77cm 42cm 42cm 45cm

scocca / shell



W N G

NEW



1625 - EV24

Struttura in metallo verniciato, scocca in polipropilene  
*Metal frame, powder coating, polypropylene shell*

h A h h  
 80cm 43cm 39cm 46cm

struttura / frame



NEW



1623 - EV03

Struttura in metallo verniciato, scocca in polipropilene

*Metal frame, powder coating, polypropylene shell*



82cm 43cm 39cm 45cm

struttura / frame



W N G V



1686 - EVC03

Struttura in metallo cromato, scocca in polipropilene

*Chromed metal frame, powder coating, polypropylene shell*



82cm 43cm 39cm 45cm



W N G V

NEW



1622 - EV07

Struttura in metallo verniciato, scocca in polipropilene

*Metal frame, powder coating, polypropylene shell*



83cm 44cm 40cm 45cm



struttura / frame



W N G V



1687 - EVC07

Struttura in metallo cromato, scocca in polipropilene

*Chromed metal frame, powder coating, polypropylene shell*



83cm 44cm 40cm 45cm



W N G V



1624 - EV012

Struttura in metallo verniciato, scocca in polipropilene  
*Metal frame, powder coating, polypropylene shell*

h A h h  
 81cm 44cm 40cm 45cm

struttura / frame



1685 - EVC12

Struttura in metallo cromato, scocca in polipropilene  
*Chromed metal frame, powder coating, polypropylene shell*

h A h h  
 81cm 44cm 40cm 45cm





893 - CT390

Struttura in metallo cromato,  
scocca in polipropilene

*Chromed metal frame,  
polypropylene shell*



81,5cm 42cm 40cm 44,5cm





074 - CT123

Struttura in metallo cromato,  
scocca in polipropilene

*Chromed metal frame,  
polypropylene shell*



82cm 39cm 42,5cm 46cm



W N R B G



922 - CT20

Struttura in metallo cromato,  
scocca in polipropilene

*Chromed metal frame,  
polypropylene shell*



86cm 38cm 39cm 45,5cm



W N R G V Y





626 - KG1C

Struttura in metallo cromato,  
seduta e schienale in polipropilene

*Chromed metal frame,  
polypropylene seat and backrest*



79cm 37cm 43cm 45cm



W N R V



219 - 1153-1

Struttura in metallo cromato,  
seduta e schienale in polipropilene

*Chromed metal frame,  
polypropylene seat and backrest*



80cm 39cm 39cm 45cm





697 - Y30S

Struttura in metallo verniciato,  
seduta e schienale in polipropilene

*Metal frame, powder coating,  
polypropylene seat and backrest*



83cm 38cm 40cm 40,5cm



W V



616 - PP8165

Struttura in metallo cromato, scocca in polipropilene

*Chromed metal frame, polypropylene shell*



81cm 54cm 55cm 43cm



R V



590 - K18C

Struttura in metallo cromato,  
seduta e schienale in polipropilene

*Chromed metal frame,  
polypropylene seat and backrest*



81cm 38cm 39cm 46cm





710 - KC07

Struttura in metallo verniciato,  
seduta e schienale in polipropilene

*Metal frame, power coating,  
polypropylene seat and backrest*

h A h h  
76cm 38cm 38cm 44cm

□ ■ ■  
W N R



343 - AB47T

Struttura in metallo cromato Ø 22 mm,  
scocca in legno multistrato

*Chromed metal frame Ø 22 mm,  
plywood shell*



85cm 41cm 41cm 45,5cm



NA WE W



1101 - BS001MC

Struttura in metallo cromato,  
scocca in legno multistrato

*Chromed metal frame,  
plywood shell*



87cm 40,5cm 41cm 46,5cm



NA WE W N





263 - AB027T

Struttura in metallo cromato Ø 22mm,  
scocca in legno multistrato

*Chromed metal frame Ø 22 mm,  
plywood shell*



86cm 41cm 42cm 45,3cm



NA WE W



670 - PE001T

Struttura in metallo cromato Ø 22 mm,  
scocca in legno multistrato

*Chromed metal frame Ø 22 mm,  
plywood shell*



86cm 44cm 43cm 46cm



NA WE



871 - MC4C

Struttura in metallo cromato e legno, scocca in legno multistrato naturale, cuscino in ecopelle

*Wood and chromed metal frame, plywood shell, with polyurethane pad*



86cm 44cm 42cm 45cm

828 - MA4C

Struttura in metallo cromato e legno, scocca legno multistrato naturale

*Wood and chromed metal frame, plywood shell*



86cm 44cm 42cm 46cm



267 - AB001T

Struttura in metallo cromato Ø 22 mm,  
scocca in legno multistrato

*Chromed metal frame Ø 22 mm,  
plywood shell*



86cm 44cm 42cm 46cm



NA WE



083 - AR100

Struttura in metallo verniciato,  
seduta in polipropilene

*Metal frame, powder coating,  
polypropylene seat*



88cm 40cm 46cm 46cm



084 - AR38

Struttura in metallo verniciato,  
seduta in polipropilene

*Metal frame, powder coating,  
polypropylene seat*



87cm 40cm 46cm 46cm

NEW



1504 - S8C

Struttura in metallo cromato, rivestimento in tessuto o in ecopelle

*Chromed metal frame, fabric or polyurethane covering*

(L59 x P53 x H76 cm)



1520 - S8V

Struttura in metallo verniciato, rivestimento in tessuto o in ecopelle

*Metal frame, powder coating, fabric or polyurethane covering*

(L59 x P53 x H76 cm)



ecopelle / polyurethane



W

N

G

T

tessuto / fabric



N

LG

B

V



Struttura in metallo verniciato, rivestimento in tessuto  
*Metal frame, powder coating, fabric covering*



1604 - 06S  
(L123 x P50 x H77 cm)

NEW



1605 - 06P  
(L64 x P50 x H77 cm)



A



B



V



Y



LR



LG





NEW



1603 - 06T  
(L63 x P47 x H37 cm)



A



B



V



Y



LR



LG





DIVANO *SOFA*  
1122 - C12S  
(L108 x P58 x H74 cm)

POLTRONA *ARMCHAIR*  
1121 - C12P  
(L60 x P58 x H74 cm)

Struttura in metallo verniciato, cuscini in ecopelle  
*Metal frame, powder coating, polyurethane cushions*







□ DIVANO SOFA  
1192 - S02  
(L170 x P81 x H82 cm)

Struttura in polipropilene e legno,  
cuscini in tessuto

*Polypropylene and wood frame,  
fabric cushions*



□ POLTRONA ARMCHAIR  
1191 - S01  
(L91 x P81 x H82 cm)





POLTRONA *ARMCHAIR*  
1657 - FU2P  
(64 x P54 x H99 cm)

POUF *OTTOMAN*  
1656 - FU1P  
(L51 x P42 x H37 cm)

Struttura in metallo, rivestimento in tessuto o in ecopelle  
*Metal frame, fabric or polyurethane covering*



ecopelle / *polyurethane*



N

M

BE

LG

tessuto / *fabric*



N

G

B

P

VI

R



NEW



1664 - TF21

Struttura in metallo verniciato, rivestimento in ecopelle

*Metal frame, powder coating, polyurethane covering*

h A h h

90cm 45cm 45cm 43cm



PA

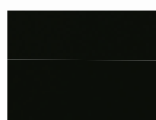

N



R

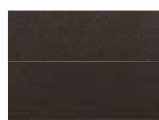

M



G



T



P



SE



625 - C2816

Struttura in metallo, rivestimento in ecopelle,  
disponibile con ruote o piedini in plastica

*Metal frame, polyurethane covering,  
available with wheel or plastic feet*

			
79cm	63cm	56cm	48cm



W



N



R



A



V



B



G



DG



BE



836 - C4041

Struttura in metallo, rivestimento in ecopelle  
*Metal frame, polyurethane covering*

h A h h  
91cm 55cm 50cm 48cm



W



N



R



A



V



B



G



BE

NEW



PA

N

M

T

BE

1633 - GU34

Struttura in metallo verniciato,  
rivestimento in ecopelle

*Metal frame, powder coating,  
polyurethane covering*

(L61 x P53 x H71 cm)

NEW



1660 -DA2

Struttura in metallo verniciato, slitte in legno, rivestimento in tessuto

*Metal frame, powder coating, solid wood sledge, fabric covering*

(L60 x P47 x H101 cm)

NEW



1659 - DA1  
Struttura in metallo verniciato,  
rivestimento in tessuto  
*Metal frame, powder coating,  
fabric or polyurethane covering*  
(L60 x P47 x H104 cm)

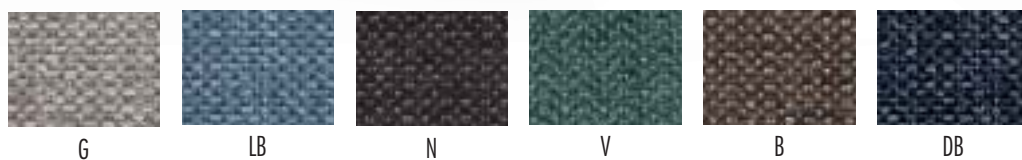





NEW



1612 - TOP5

Struttura cromata girevole in metallo, rivestimento in ecopelle  
*Chromed metal swivel frame, polyurethane covering*

h A h h  
80cm 48cm 45cm 46cm

ecopelle / polyurethane



G

T



PA

M



1240 - V61  
(L64 x P59 x H74 cm)

Struttura in legno,  
rivestimento in ecopelle  
*Wood frame,  
polyurethane covering*



1241 - V61D  
(L113 x P59 x H74 cm)



432 - X17P PATENT

Struttura in acciaio inox,  
rivestimento anteriore in pelle,  
posteriore in ecopelle

*Stainless steel frame,  
leather front covering  
polyurethane back covering*

620 - X17PS PATENT

Struttura in acciaio inox,  
rivestimento in ecopelle

*Stainless steel frame,  
polyurethane covering*

(L76 x P70 x H68 cm)



W N



475 - X17D2 PATENT

Struttura in acciaio inox, rivestimento anteriore in pelle, posteriore in ecopelle

*Stainless steel frame, leather front covering, polyurethane back covering*

619 - X17D2S PATENT

Struttura in acciaio inox, rivestimento in ecopelle

*Stainless steel frame, polyurethane covering*

(L130 x P70 x H68 cm)



W

N





431 - X17D3 PATENT

Struttura in acciaio inox, rivestimento anteriore in pelle, posteriore in ecopelle

*Stainless steel frame, leather front covering, polyurethane back covering*

618 - X17D3S PATENT

Struttura in acciaio inox, rivestimento in ecopelle

*Stainless steel frame, polyurethane covering*

(L180 x P70 x H68 cm)

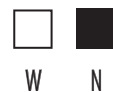



ANGOLO *CORNER*  
1025 - 69C  
(L71 x P71 x H70 cm)

POLTRONA S/B *CHAIR*  
1026 - 69M  
(L71 x P71 x H70 cm)

POUF *POUF*  
1027 - 69FT  
(L71 x P71 x H43 cm)

Struttura in acciaio inox,  
rivestimento in ecopelle

*Stainless steel frame,  
polyurethane covering*





1509 -D062

Struttura in legno, rivestimento in tessuto

Wood frame, fabric covering



(L59 x P53 x H84 cm)

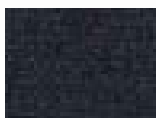

N



BE

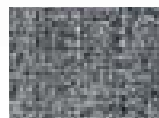

LG



DG



B



M





1510 -D080

Struttura in legno, rivestimento in tessuto

*Wood frame, fabric covering*

(L115 x P53 x H84 cm)



N



BE

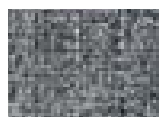

LG



DG



B



M



1340 - FE1

Struttura in legno,  
rivestimento in tessuto  
o in pelle rigenerata

*Wood frame,  
fabric or bonded  
leather covering*

h A h h  
80cm 70cm 78cm 44cm



tessuto / fabric



M



CA

pelle rigenerata / bonded leather

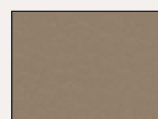

T



N



M

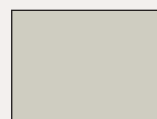

C



NEW



1618 - TOP11  
Struttura in legno,  
rivestimento in tessuto  
*Wood frame,  
fabric or bonded*  
(L65 x P55 x H85 cm)

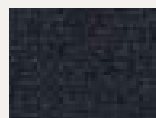

N



BE

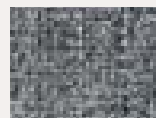

LG



DG



M



1000 - JY06

Rivestimento in ecopelle

*Polyurethane back covering*

(L74 x P70 x H74 cm)



W

N

M

NEW



1643 - 4BC2

Struttura in plastica,  
base in alluminio lucido,  
seduta e schienale in tessuto,  
7 possibilità di regolazione

*Plastic frame, polished aluminum base,  
fabric seat and backrest,  
7 positions of adjustment*

h A h h  
109/98cm 66cm 64cm 58/47cm

NEW



1642 - 4B2

Struttura in plastica,  
base in alluminio verniciata,  
seduta e schienale in tessuto,  
7 possibilità di regolazione

*Plastic frame, aluminum base,  
powder coating, fabric seat and backrest,  
7 positions of adjustment*

h A h h  
109/98cm 66cm 64cm 58/47cm

tessuto / fabric

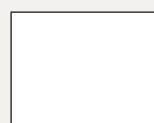

W

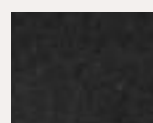

N

struttura / frame



W



N



762 - LS31

Struttura in fusione d'alluminio,  
scocca in textilene

*Aluminum frame,  
textylene shell*

h A h h  
95/88cm 59cm 50cm 51/44cm

□ ■  
W N





763 - LS30

Struttura in fusione d'alluminio,  
scocca in textilene

*Aluminum frame,  
textylene shell*

  
 110/103cm 59cm 50cm 51/44cm

  
 W N



764 - LS11

Struttura in fusione d'alluminio,  
scocca in ecopelle

*Aluminum frame,  
polyurethane shell*

h A h h  
95/88cm 59cm 50cm 51/44cm

□ ■  
W N



765 - LS10

Struttura in fusione d'alluminio,  
scocca in ecopelle

*Aluminum frame,  
polyurethane shell*



110/103cm 59cm 50cm 51/44cm



W N





1237 - HM2

h A h h  
111/105cm 58cm 59cm 50/44cm

1238 - MM2

h A h h  
95/89cm 58cm 59cm 50/44cm

1239 - VM2

h A h h  
94cm 57cm 56cm 46cm



Struttura in alluminio e acciaio cromato, rivestimento in textilene / Aluminum and chromed iron frame, textilene covering



1234 - HL1

h A h h  
111/105cm 58cm 59cm 50/44cm

1235 - ML1

h A h h  
95/89cm 58cm 59cm 50/44cm

1236 - VL1

h A h h  
94cm 57cm 56cm 46cm



Struttura in alluminio e acciaio cromato, rivestimento in ecopelle / Aluminum and chromed iron frame, polyurethane covering



529 - W81

Struttura in nylon con fibra di vetro,  
base in alluminio cromata, seduta in tessuto,  
6 possibilità di regolazione

*Nylon frame with fiberglass,  
chromed aluminum base,  
fabric seat, textylene backrest,  
6 positions of adjustment*



h A h h  
98,5/90cm 51,5cm 50cm 51,5/43cm





671 - W03

Base cromata, rivestimento in  
textilene ed ecopelle

*Chromed base, polyurethane and  
mesh fabric upholstery*

h A h h  
115/107cm 61cm 63cm 52/45cm



606 - W94

Struttura in nylon con fibra di vetro,  
base cromata, seduta in tessuto,  
8 possibilità di regolazione

*Nylon frame with fiberglass, chromed base,  
fabric seat, textylene backrest,  
8 positions of adjustment*

h A h h  
122/113cm 51,5cm 50cm 52/43cm

NEW



1628 - EV11

Struttura in metallo verniciato, scocca in polipropilene  
*Metal frame, powder coating, polypropylene shell*

h A h h  
 86/93cm 44cm 37cm 47/54cm

struttura / frame



W N

scocca / shell



W N G



1629 - EV13

Struttura in metallo cromato, scocca in polipropilene  
*Chromed metal frame, polypropylene shell*

h A h h  
 86/93cm 44cm 37cm 47/54cm





1491 - YG98

Struttura in metallo cromato, scocca in polipropilene, cuscino in ecopelle  
*Chromed metal frame, polypropylene shell, polyurethane pad*



h A h h  
 76/81cm 42cm 42cm 45/50cm

scocca / shell



1490 - YG97

Struttura in metallo verniciato, scocca in polipropilene, cuscino in ecopelle  
*Metal frame, powder coating, polypropylene shell, polyurethane pad*

h A h h  
 76/81cm 42cm 42cm 45/50cm



1126 - K03

Struttura in metallo cromato, scocca in polipropilene, cuscino in ecopelle  
 Chromed metal frame, polypropylene shell, polyurethane pad

h A h h  
 90/78cm 39cm 43cm 54/42cm

W N R Y G V



669 - WX910

Struttura in metallo cromato,  
seduta e schienale in ecopelle

*Chromed metal frame,  
PVC seat and back*



  
 92/84cm 49cm 57cm 50/42cm



  
 W N R

NEW



1651 - J01G

Struttura in metallo cromato oro, rivestimento in velluto

*Chromed gold metal frame, velved fabric covering*

h A h h  
97cm 46cm 42cm 66cm



LG



DG



LB



DB



V



R



1007 - F600

Struttura in metallo cromato, rivestimento in ecopelle

*Chromed metal frame, polyurethane covering*



100cm 41cm 37cm 76cm





1497 - K31

Struttura in legno e metallo,  
seduta in polipropilene, cuscino in ecopelle

*Wood and metal frame,  
polypropylene seat, polyurethane pad*

h A h h  
99cm 39cm 33cm 76cm





1303 - PW026

Struttura in legno e metallo,  
scocca in polipropilene

*Wood and metal frame,  
polypropylene shell*



  
 105cm 44cm 40cm 69cm



  
 W N G

NEW



1655 - FU95

Struttura in legno, seduta in polipropilene,  
cuscino in ecopelle

*Wood frame, polypropylene seat,  
polyurethane pad*

h A h h  
89cm 39cm 35cm 72cm

□ ■ ▒  
W N G





1500 - K32

Struttura in legno, seduta in polipropilene,  
cuscino in ecopelle

*Wood frame, polypropylene seat,  
polyurethane pad*



  
 85cm 40cm 40cm 76cm



  
 W N G

NEW



1627 - EV36

Struttura in legno di quercia,  
scocca in polipropilene

*Oak wood frame, polypropylene shell*

h A h h  
102cm 39cm 34cm 77cm



NEW



1639 - EV37

Struttura in legno di quercia,  
scocca in polipropilene, seduta in ecopelle

*Oak wood frame, polypropylene shell,  
polyurethane pad*

h A h h  
110cm 46cm 41cm 72cm





646 - AB047BB  
 Struttura in metallo cromato,  
 scocca in legno multistrato  
*Metal steel frame,  
 plywood shell*



h A h h h  
 102cm 39,5cm 39,5cm 75,5cm

NA WE W



442 - BB010

Struttura in metallo cromato,  
scocca in legno multistrato

*Chromed metal frame,  
plywood shell*



102cm 39,5cm 39,5cm 75,5cm





932 - K38

Struttura in metallo cromato,  
scocca in polipropilene

*Chromed metal frame,  
polypropylene shell*



100cm 39cm 34cm 77cm





443 - CT123-1

Struttura in metallo cromato,  
scocca in polipropilene

*Chromed metal frame,  
polypropylene shell*



112cm 39cm 42,5cm 76cm



W N R



815 - C77

Struttura in metallo cromato,  
seduta schienale in polipropilene

*Chromed metal frame,  
polypropylene seat and backrest*



79cm 37cm 43cm 74,5cm



W N R V



221 - B1201

Struttura in metallo cromato,  
seduta e schienale in polipropilene

*Chromed metal frame,  
polypropylene seat and backrest*

h A h h  
111cm 39cm 39cm 75cm







838 - C4063

Struttura in metallo cromato,  
seduta e schienale in ecopelle

*Chromed metal frame,  
PVC seat and backrest*



129cm 49cm 56cm 75cm



W N R

NEW

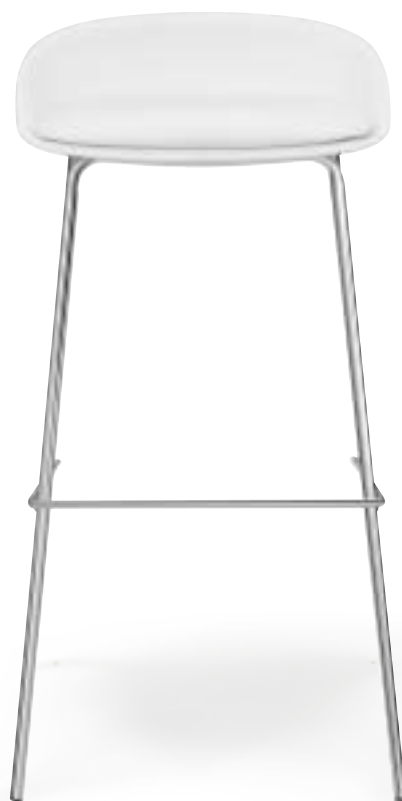

1630 - EV23

Struttura in metallo cromato, seduta in polipropilene, cuscino in ecopelle

*Chromed metal frame, polypropylene seat, polyurethane pad*



h A h h  
87cm 39cm 39cm 77cm





513 - A661A

Struttura in metallo cromato,  
seduta in ecopelle

*Chromed metal frame,  
polyurethane seat*

□ □  
75,5cm 38,5cm

□ ■  
W N



□ SGABELLO *BAR STOOL*  
223 - B010

Struttura in metallo cromato,  
seduta girevole in ecopelle

*Chromed metal frame,  
swivel seat, polyurethane covering*

□ □  
33cm 76cm

□ ■ ■  
W N R



245 - B030

Struttura in metallo cromato,  
seduta girevole in ecopelle

*Chromed metal frame,  
swivel seat, polyurethane covering  
seat and backrest*



107,5cm 38cm 76cm



W N R B





512 - A174

Struttura in metallo cromato,  
seduta in ecopelle

*Chromed metal frame,  
polyurethane seat*



95/73cm 40cm 38cm 84/62cm





997 - K3001

Struttura in metallo cromato,  
scocca in polipropilene,  
cuscino in ecopelle

*Chromed metal frame,  
polypropylene shell,  
polyurethane pad*



  
 107/86cm 41cm 37cm 81/60cm





  
 W N R A V G



1113 - BY035

Struttura in metallo cromato,  
seduta in ecopelle

*Chromed metal frame, PVC seat*

     
108/86cm 37cm 32cm 80/58cm

    
W N R



NEW



1566 - V12  
 Struttura in metallo cromato,  
 seduta in textilene  
*Chromed metal frame,  
 textylene seat*

  
 114/93cm 38cm 35cm 82/61cm

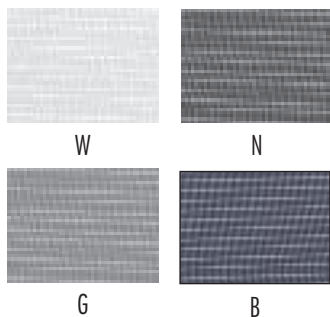



933 - K08

Struttura in acciaio cromato,  
scocca in polipropilene

*Chromed steel frame,  
polypropylene shell*



104/83cm 39cm 34cm 81/60cm





934 - K00

Struttura in metallo cromato, scocca in polipropilene  
 Chromed metal base, polypropylene shell

  
 105/83cm 41cm 38cm 81/59cm



  
 W N R V



1031 - 795

Struttura in metallo cromato,  
scocca in polipropilene

*Chromed metal frame,  
polypropylene shell*

h A h h  
94/73 cm 39cm 34cm 78/57cm

□ ■  
W N



595 - T010

Struttura in metallo cromato,  
seduta in ABS

*Chromed metal frame,  
ABS seat*

h A h h  
93/73cm 36cm 40cm 79/59cm



W N



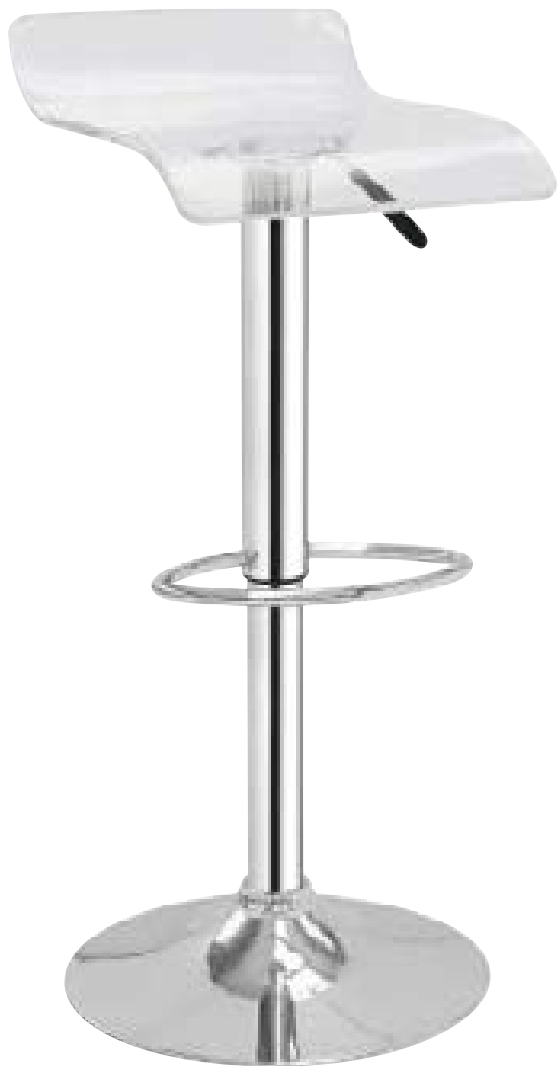

528 - 238A

Struttura in metallo cromato,  
seduta in metacrilato

*Chromed metal base, methacrylate  
seat*



84,5/64cm 40cm 36cm 77/56,5cm



T-T T-O



531 - 219B

Base in metallo cromato,  
scocca in ABS rivestita in ecopelle

*Chromed metal base,  
ABS shell, polyurethane covering*



  
 88/68cm 44cm 40cm 78/58cm



  
 W N R



419 - IF216

Base in metallo cromato,  
seduta in ABS

*Chromed metal base,  
ABS seat*

□ □  
59/45cm 33cm

□ ■ ▒  
W N G





1123 - D600

Struttura in metallo verniciato e grezzo, seduta in ecopelle  
*Metal frame, powder coating and raw, polyurethane seat*

47cm 37cm

W N R V Y L

NEW



1665 - TF22

Struttura in metallo verniciato, piano allungabile in cristallo e melamina antigraffio spessore 11 mm  
*Metal frame, powder coating, 11 mm tempered glass and scratchproof melamine top and extension*  
(L160+40+40 x P90 x H75 cm)

NEW





1558 - 9TD

Struttura in metallo verniciato,  
piano allungabile in cristallo,  
spessore 10 mm

*Metal frame, powder coating,  
10 mm tempered  
glass top and extension*

(L160+40+40 x P90 x H76 cm)

1471 - 9TA

Struttura in metallo verniciato,  
piano allungabile in cristallo  
effetto pietra  
spessore 10,5 mm

*Metal frame, powder coating,  
10,5 mm tempered  
stoneglass top and extension*

(L160+40+40 x P90 x H76 cm)

1472 - 9TB

Struttura in metallo verniciato,  
piano allungabile  
in vetroceramica temperato  
spessore 14,5 mm

*Metal frame, powder coating,  
14,5 mm ceramic tempered  
glass top and extension*

(L160+40+40 x P90 x H76 cm)

1473 - 9TC

Struttura in metallo verniciato,  
piano allungabile  
in vetro-melamina temperato  
resistente al fuoco spessore 11 mm

*Metal frame, powder coating,  
11 mm melamine tempered  
glass top and extension, fire resistant*

(L160/+40+40 x P90 x H76 cm)



struttura / frame

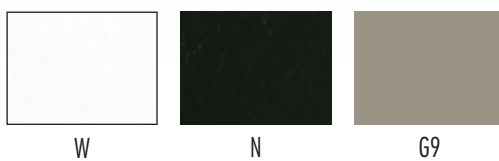

W

N

G9

vetroceramica / ceramic glass



C2D

C4D

cristallo / tempered glass

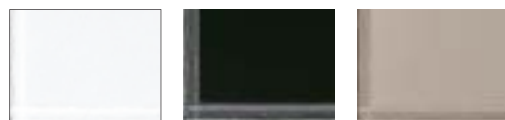

W

N

G9G

cristallo effetto pietra / stoneglass



S1D

S2D

vetro-melamina  
melamine glass



M2D



1442 - A58

Struttura in metallo verniciato, piano allungabile in cristallo spessore 10 mm

*Painted metal frame, 10 mm tempered glass top and extension*

(L180/220 x P90 x H76 cm)

struttura / frame

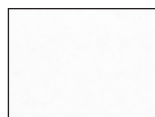

W



N



G9





1445 - A75G

Struttura in metallo verniciato, gambe in legno, piano allungabile in cristallo effetto pietra spessore 10,5 mm

*Metal frame, powder coating, wood legs, 10,5 mm tempered stoneglass top and extension  
(L140/200 x P80 x H76 cm)*







1324 - A75  
(L160/220 x P90 x H76 cm)

1444 - A75M  
(L140/200 x P80 x H76 cm)

Struttura in metallo verniciato, gambe in legno, piano allungabile in MDF verniciato effetto pietra  
*Metal frame, powder coating, wood legs, top and extension painted in stone color*

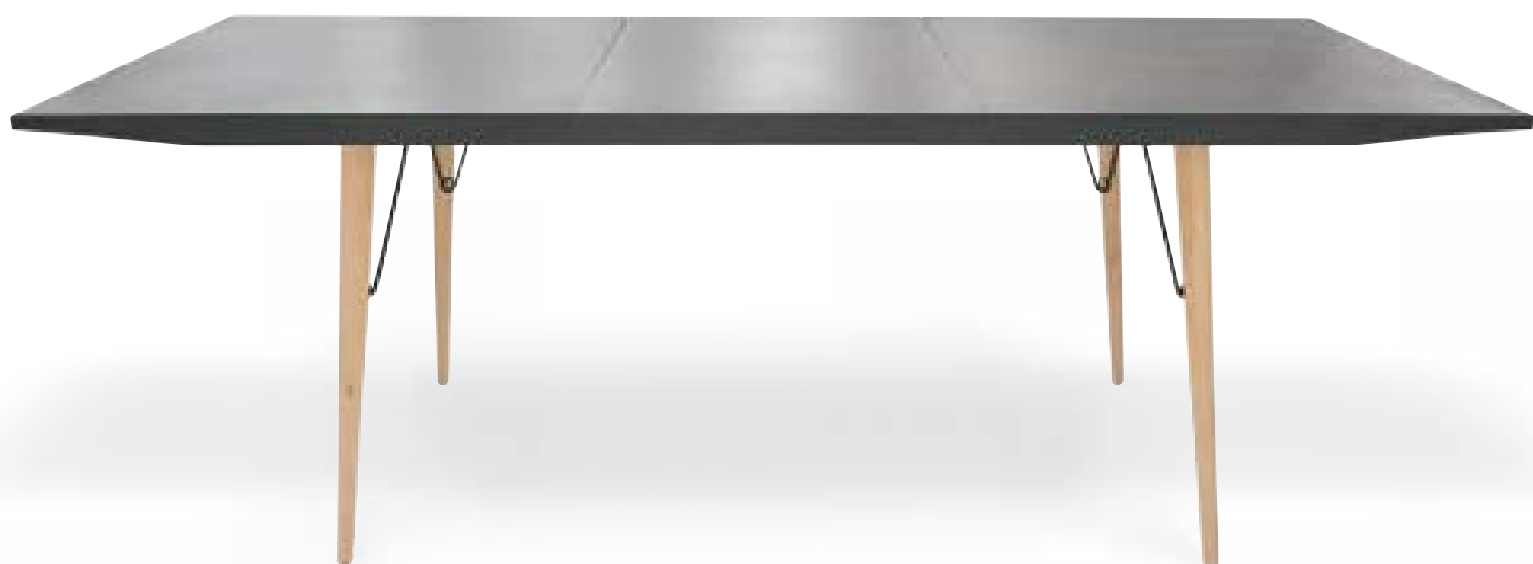

NEW



SEDIA CHAIR  
1485 - F50

TAVOLO TABLE  
1608 - TOP1

Struttura in metallo verniciato, gambe in legno, piano allungabile in vetroceramica spessore 11 mm  
*Metal frame, powder coating, solid wood legs, 11 mm ceramic tempered glass top and extension*  
(L180/230 x P90 x H75 cm)

NEW



NEW



SEDIA CHAIR  
1423 - YM2

TAVOLO TABLE  
1658 - RI9A

Struttura in metallo verniciato, piano allungabile in vetro acidato spessore 10 mm  
*10 mm metal frame, powder coating, glazed glass*  
(L160/240 x P90 x H76 cm)

NEW



NEW



SEDIA CHAIR  
821 - RF4BC

TAVOLO TABLE  
1609 - TOP2

Struttura in alluminio, gambe in legno, piano allungabile in cristallo spessore 10 mm  
*Aluminum frame, solid wood legs, 10 mm tempered glass top*  
(L160+40+40 x P90 x H75 cm)



NEW



NEW



SEDIA *CHAIR*  
1692 - PA4

TAVOLO *TABLE*  
1610 - TOP3

Struttura in legno, gambe in legno, piano allungabile in MDF impiallacciato  
*Wood frame, solid wood legs, walnut veneered MDF top and extension*  
(L160/210 x P90 x H76 cm)

NEW





SEDIA CHAIR  
824 - RF97

TAVOLO TABLE  
1694 - DE93T

Struttura in metallo verniciato, piano allungabile in vetroceramica spessore 13,5 mm  
*Metal frame, powder coating, 13,5 mm ceramic tempered glass top and extension*  
(L160+40+40 x P90 x H76 cm)



1594 - DE86T

Struttura in metallo verniciato, piano allungabile in vetroceramica spessore 11 mm, estensione in MDF laccata

*Metal frame, powder coating, 11 mm ceramic tempered glass top, high gloss MDF and extension*

(Ø 120+50 x H76 cm)



1539 - WL01

Struttura in metallo verniciato, piano in MDF impiallacciato

*Metal frame, powder coating, veneered MDF top*

(L198 x P112 x H76 cm)



1447 - T21

Struttura in metallo verniciato, piano in MDF impiallacciato

*Metal frame, powder coating, veneered MDF top*

(L180 x P95 x H75 cm)

NEW



1621 - MIT83

Struttura in legno, piano in MDF impiallacciato

*Rubber wood frame, MDF top with oak veneer*

(L180 x P90 x H76 cm)



1675 - MIT82

Struttura in legno, piano in marmo sintetico

*Rubber wood frame, synthetic marble top*

(L180 x P90 x H76 cm)



NEW



1677 - MIT10

Struttura in metallo verniciato, piano in MDF impiallacciato

*Metal frame, powder coating MDF top with ash veneer*

(Ø 137 x H76 cm)



1676 - MIT67

Struttura in metallo verniciato, piano in marmo sintetico

*Metal frame, powder coating synthetic marble top*

(Ø 135 x H76 cm)

NEW



SEDIA CHAIR  
1662 - DA4

TAVOLO TABLE  
1668 - BA16

Struttura in metallo dorato, piano in legno multistrato impiallacciato  
*Plating gold metal frame, plywood top with veneer*

(L75 x P75 x H75 cm)



SEDIA CHAIR  
1661 - DA3

TAVOLO TABLE  
1634 - GU33

Struttura in metallo verniciato, base in acciaio inox, piano in MDF impiallacciato  
*Metal frame, powder coating, stainless steel base, MDF top with veneer*

(Ø 120 x H76 cm)



SEDIA CHAIR  
1456 - 30D

TAVOLO TABLE  
1450 - 28DT

Struttura in metallo verniciato, piano allungabile in cristallo  
spessore 8 mm, estensione in MDF laccato

*Metal frame, powder coating, 8 mm tempered glass top,  
extension in MDF painting*

(L140+45+45 x P90 x H76 cm)

cristallo / tempered glass

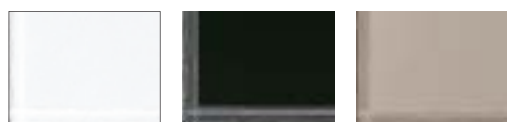

W

N

G9G

struttura & MDF / frame & MDF



W

N

G9



1458 - 18DT

Struttura in metallo verniciato,  
piano allungabile in MDF laccato

*Metal frame, powder coating,  
top and extension in MDF high gloss  
(L110/160 x P70 x H76 cm)*



piano MDF / MDF top



W

N

G9G

struttura / frame



W

N

G9



SEDIA CHAIR  
824 - RF97

TAVOLO TABLE  
1457 - 65DT

Struttura in metallo verniciato, piano allungabile in MDF laccato  
*Metal frame, powder coating, top and extension in MDF high gloss*  
(L130/+40+40 x P80 x H76 cm)



piano MDF / MDF top

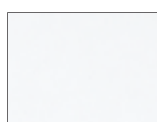

W



N



G9G

struttura / frame

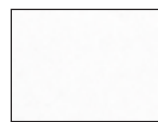

W



N



G9



SEDIA CHAIR  
1451 - 7BD

TAVOLO TABLE  
1455 - 75DTG

Struttura in metallo verniciato, piano allungabile  
in cristallo spessore 8 mm

*Metal frame, powder coating, 8 mm tempered glass top  
and extension*

(L122/182 x P82 x H76 cm)

TAVOLO TABLE  
1454 - 75DTC

Struttura in metallo verniciato, piano allungabile  
in cristallo effetto pietra spessore 8,5 mm

*Metal frame, powder coating, 8,5 mm tempered stoneglass  
top and extension*

(L122/182 x P82 x H76 cm)





struttura / frame

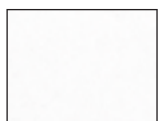

W



N



G9

cristallo / tempered glass

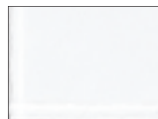

W

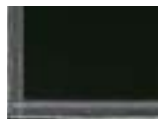

N



G9G

cristallo effetto pietra / stoneglass



J01



J08



J09



1453 - 73DTG

Struttura in metallo verniciato, piano allungabile  
in cristallo spessore 8 mm

*Metal frame, powder coating, 8 mm tempered glass top  
and extension*

(L120/170 x P80 x H76 cm)

1452 - 73DTC

Struttura in metallo verniciato, piano allungabile  
in cristallo effetto pietra spessore 8,5 mm

*Metal frame, powder coating, 8,5 mm tempered  
stoneglass top and extension*

(L120/170 x P80 x H76 cm)

1466 - 73DTM

Struttura in metallo verniciato, piano allungabile in vetroceramica  
temperato spessore 11,5 mm

*Metal frame, powder coating, 11,5 mm ceramic tempered  
glass top and extension*

(L120/170 x P80 x H76 cm)

1467 - 73DTN

Struttura in metallo verniciato, piano allungabile  
in vetro-melamina temperato resistente al fuoco spessore 8,5 mm

*Metal frame, powder coating, 8,5 mm melamine tempered  
glass top and extension, fire resistant*

(L120/170 x P80 x H76 cm)



struttura / frame



W

N

G9

G1

vetroceramica / ceramic glass



C2D

C4D

cristallo / tempered glass

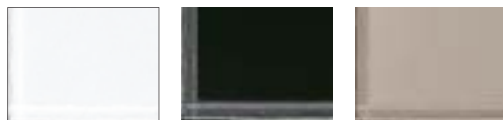

W

N

G9G

cristallo effetto pietra / stoneglass



S2D

S3D

vetro-melamina  
melamine glass



M2D



SEDIA CHAIR  
824 - RF97

TAVOLO TABLE  
1459 - 88DT

Struttura in metallo verniciato,  
piano allungabile in cristallo spessore 9 mm  
*Metal frame, powder coating,  
9 mm tempered glass top and extension  
(L120+35+35 x P80 x H76 cm)*



piano MDF / MDF top



W

N

G9G

struttura / frame



W

N

G9



1460 - 78DT

Struttura in metallo verniciato, piano allungabile in cristallo spessore 8 mm

*Metal frame, powder coating, 8 mm tempered glass top and extension*

(L120+45+45 x P86 x H75 cm)



*cristallo / tempered glass*

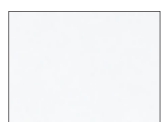

W

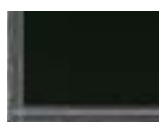

N



G9G



G10G

*struttura / frame*

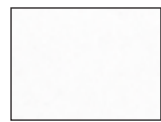

W



N



G9



G10



1461 - 03DT

Struttura in metallo verniciato,  
piano allungabile in cristallo spessore 8 mm,  
estensione in MDF impiallacciato

*Metal frame, powder coating,  
8mm tempered glass,  
top and extension in veneered MDF*  
(L120+45+45+45 x P80 x H76/43 cm)





*cristallo / tempered glass*

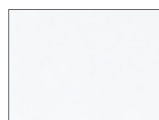

W

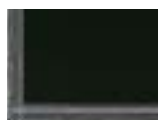

N



G9G



G10G

*struttura / frame*

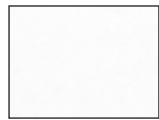

W



N



G9



G10



841 - RF22

Struttura in metallo verniciato, piano allungabile in cristallo spessore 8 mm

*Metal frame, powder coating, 8 mm tempered glass top and extension*  
(100/160 x 70 x 76/45 cm)



W



G





509 - TB015

Struttura in metallo cromato,  
piano in MDF

*Chromed metal frame,  
veneered MDF top*  
(L120 x P80 x H74 cm)

507 - TB007

Struttura in metallo verniciato,  
piano in MDF

*Metal frame, powder coating,  
veneered MDF top*  
(L120 x P80 x H74 cm)



TAVOLO / TABLE

1195 - TB028A  
(L70 x P70 x H76 cm)

1196 - TB028B  
(L80 x P80 x H76 cm)

1197 - TB028C  
(L120 x P80 x H76 cm)

Struttura in metallo cromato,  
piano in MDF laccato

*Chromed metal frame,  
painted MDF top*



GAMBE / LEGS

1198 - TB028T

Gambe in metallo cromato  
*Chromed metal legs*



1562 - TB08      Struttura in legno multistrato, piano in MDF laccato      (L120 x P80 x H75 cm)  
*Playwood frame, painting MDF top*



1563 - TB07  
Struttura in legno multistrato,  
piano in MDF laccato  
*Playwood frame, painted MDF top*  
(L80 x P80 x H75 cm)





938 - K54 (L80 x P80 x H74 cm)

939 - K55 (L120 x P80 x H74 cm)

Struttura in metallo, gambe in legno,  
piano in MDF laccato

*Metal frame, powder coating,  
solid wood legs, painted MDF top*

piano / top



W

N



1040 - G06  
Tavolo in legno  
*Wood table*  
(L80 x P80 x H73 cm)



1039 - G05  
Tavolo in legno  
*Wood table*  
(L80 x P80 x H73 cm)



□ TAVOLO TABLE  
 984 - Z80 (Ø 80 cm x 110cm)  
 Struttura in metallo verniciato,  
 piano in polietilene  
*Metal frame, powder coating  
 polyethylene top*



985 - Z154 (Ø 154 cm)  
 983 - Z183 (Ø 183 cm)  
 Struttura pieghevole in metallo verniciato,  
 piano in polietilene pieghevole  
*Folding metal frame,  
 powder coating, folding polyethylene top*



944 - Z152 (153 x 76 cm)  
 945 - Z183C (183 x 76 cm)  
 Struttura in metallo verniciato,  
 piano in polietilene  
*Metal frame, powder coating,  
 polyethylene top*



537 - CS205

Base in acciaio cromato,  
piano in vetro temperato  
spessore 13 mm

*Chromed steel base,  
13 mm tempered glass  
(Ø 70 x H 72 cm)*



510 - BT001G

Struttura in metallo cromato,  
piano in vetro temperato

*Chromed metal base,  
tempered glass  
(Ø 60 cm H 113 cm)*



538 - CS206

(L70 x P70 x H72 cm)

621 - CS207

(L80 x P80 x H72 cm)

Base in acciaio cromato, piano in vetro temperato spessore 13 mm  
*Chromed steel base, 13 mm tempered glass*



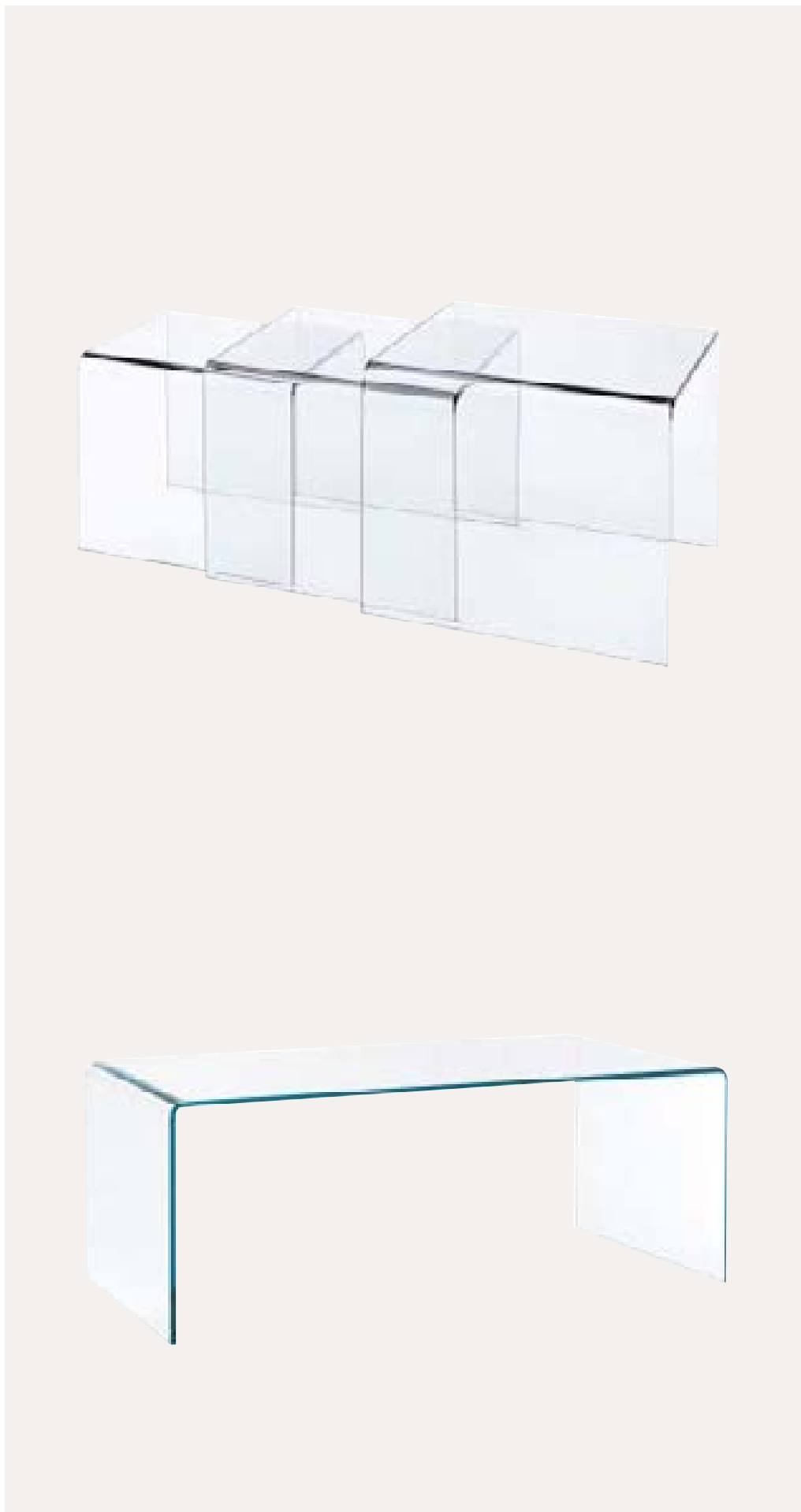

302 - BZ023

Composizioni in vetro temperato  
spessore 12 mm

*12 mm tempered glass set*

(L42 x P42 x H42 cm)

(L38 x P38 x H38 cm)

(L34 x P34 x H34 cm)

303 - BZ022

Vetro temperato spessore 12 mm

*12 mm tempered glass*

(L120 x P60 x H40 cm)

NEW

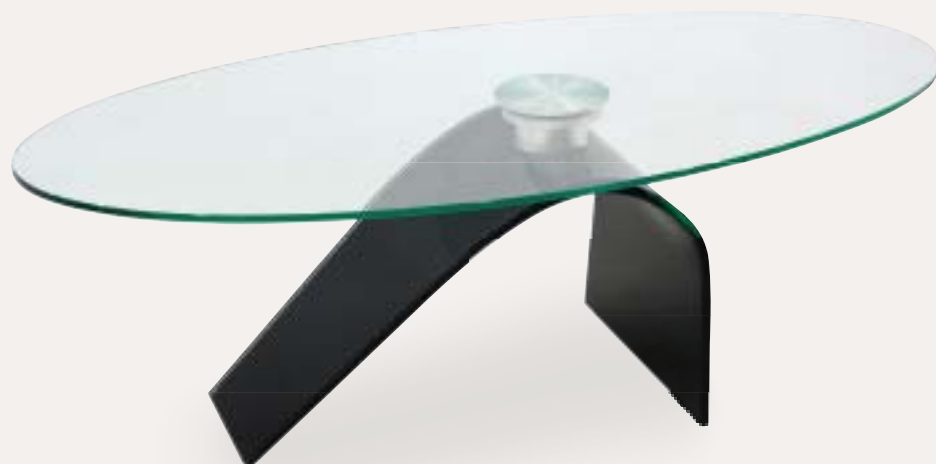

1620 - EL81

Base curva nera in vetro temperato spessore 15 mm, piano in vetro temperato spessore 10 mm

*15 mm black bending base in tempered glass, 10 mm tempered glass top*

(L125 x P65 x H42 cm)



1666 - TF23

Struttura in MDF laccato con inserti in ceramica, base in metallo verniciato, piano di ceramica

*Painted MDF frame with stick ceramic, metal base, powder coating, ceramic top*

(L120 x P60 x H45 cm)

NEW



1653 - B01T

Struttura in metallo cromato,  
piano in vetro temperato

*Chromed metal frame,  
tempered glass top*

(L60 x P60 x H45 cm)



1671 - BA03

Struttura in metallo verniciato,  
piano in legno multistrato impiallacciato

*Metal frame, powder coating,  
veneered plywood top*

(Ø 75 cm H44 cm)

NEW



1678 - SE10  
(L74,5 x P49,5 x H42,5 cm)

1679 - SE75  
(L100 x P49,5 x H42,5 cm)

piano / top



Struttura in metallo verniciato, piano in MDF verniciato  
*Metal frame, powder coating, painted MDF top*



NEW



1681 - SE02

Struttura in metallo verniciato, piano MDF verniciato

*Metal frame, powder coating, painted MDF top*

(L92x P50 x H40,5 cm)

piano / top



NEW



1611 - TOP4

Struttura in metallo verniciato, piano in MDF impiallacciato noce

*Metal frame, powder coating, walnut veneered MDF top*

(L80 x P80 x H47 cm)



1619 - TOP12

Struttura in metallo verniciato, piano in MDF impiallacciato noce

*Metal frame, powder coating, walnut veneered MDF top*

(L120 x P60 x H35 cm)



1565 - TS7

Struttura in legno multistrato,  
piano in MDF laccato

*Playwood frame,  
painting MDF top*

(L55 x P55 x H51 cm)

piano / top



W N

gambe / legs



NA W N



**Interno**

***Indoor***





**Basi & piani  
per tavoli**

***Table bases  
& tops***

NEW



1648 - EG3  
(52 x 52 x H72 cm) kg 3,7



1644 - S10  
(50 x 50 x H72 cm) kg 3,6

Struttura in metallo dorato  
*Plating gold metal frame*



1646 - EG2  
(Ø 40 x H72 cm) kg 11,5



1645 - EG1  
(40 x 40 x H72 cm) kg 14

NEW



1647 - EC1  
Struttura in acciaio inox cromato  
*Chromed stainless steel frame*  
(52 x 52 x H72 cm) kg 3,7



1346 - D01  
Struttura in legno  
e metallo verniciato  
*Wood and metal frame*  
(59 x 59 x H72 cm)

NEW



1592 - BAB1  
Struttura in metallo verniciato  
*Metal frame, powder coating*  
(45 x 45 x H42 cm)

NEW



1680 - BB07  
Struttura in legno multistrato  
*Plywood frame*  
(67 x 67 x H72 cm)



980 - TB015S (L80 x P80 x H72,5 cm )

986 - TB016S (L120 x P80 x H72,5 cm )

Struttura in metallo cromato

*Chromed metal frame*



988 - TB015V (L80 x P80 x H72,5 cm )

987 - TB016V (L120 x P80 x H72,5 cm )

Struttura in metallo verniciato

*Metal frame, powder coating*



1354 - T40RU

Base in ghisa verniciata,  
effetto ruggine

*Cast iron base, powder coating,  
rust look*

(L40 x P40 x H72 cm) kg. 15

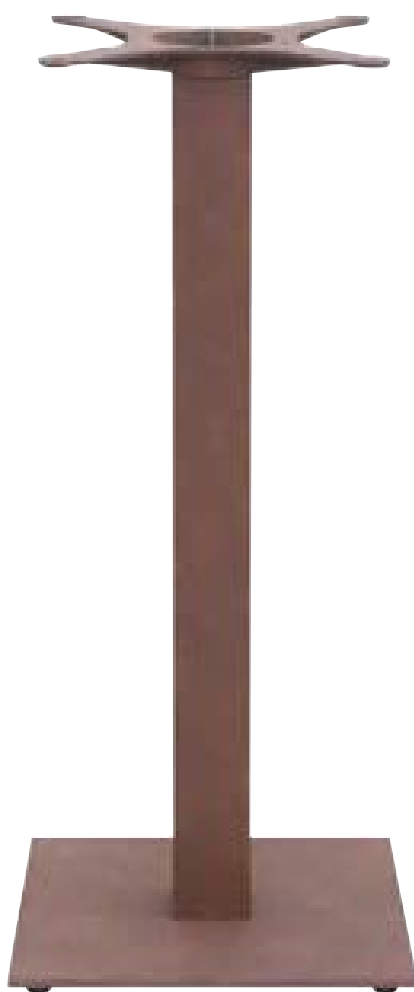

1355 - T40RU

Base in ghisa verniciata,  
effetto ruggine

*Cast iron base, powder coating,  
rust look*

(L40 x P40 x H108 cm) kg. 17

363 - 6032I  
(40 x 40 x H72 cm) kg 15

1572 - 6034I  
(50 x 50 x H72 cm) kg 22

Base in acciaio inox satinato,  
piedini regolabili

*Satin stainless steel base*

842 - 6032A

Base in alluminio,  
piedini regolabili

*Aluminum base*

(40 x 40 x H73 cm) kg 15



364 - 6032C  
(40 x 40 x H72 cm) kg 15

1571 - 6034C  
(50 x 50 x H72 cm) kg 22

Base in acciaio cromato,  
piedini regolabili

*Chromed steel base*

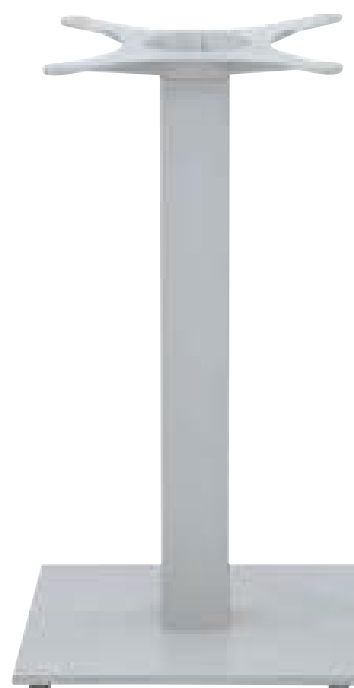
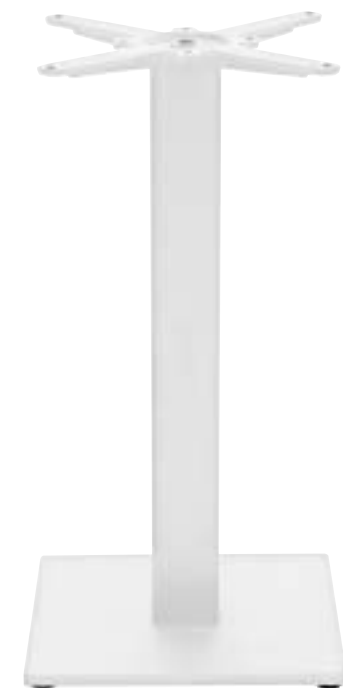
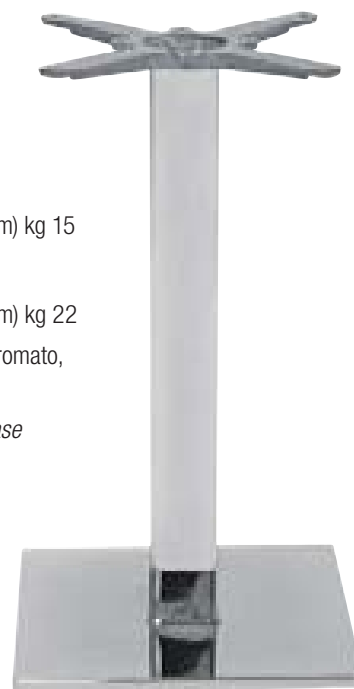

365 - 340N  
(40 x 40 x H72 cm) kg 15

1276 - 350N  
(50 x 50 x H72 cm) kg 22

Base in ghisa verniciata,  
piedini regolabili

*Cast iron base,  
powder coating*



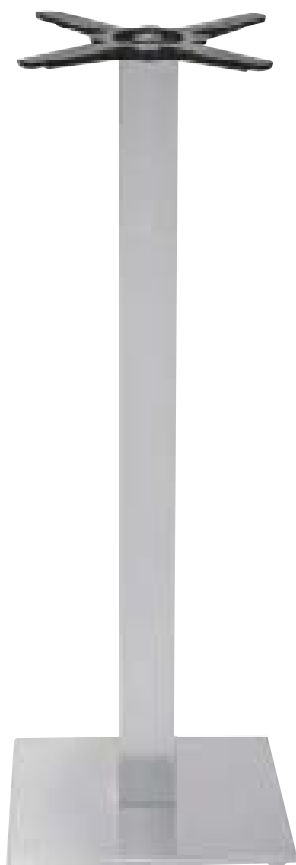

400 - 339HI  
Base in acciaio inox satinato, piedini regolabili

*Satin stainless steel base*  
(40 x 40 x H108 cm) kg 17

856 - 339HA  
Base in alluminio, piedini regolabili

*Aluminum base*  
(40 x 40 x H108 cm) kg 17

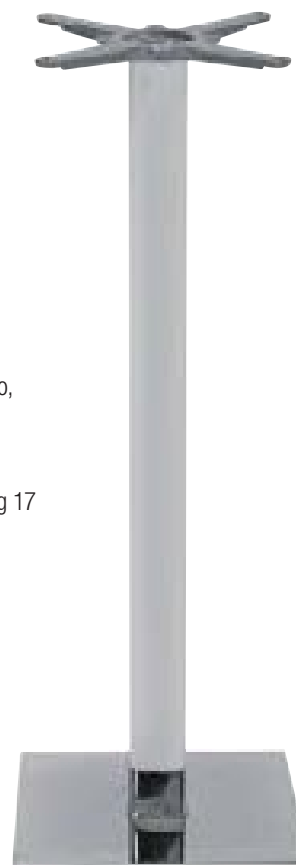

401 - 339HC  
Base in acciaio cromato, piedini regolabili

*Chromed steel base*  
(40 x 40 x H108 cm) kg 17



749 - 33940H  
Base in ghisa verniciata, piedini regolabili



*Cast iron base, powder coating*  
(40 x 40 x H108 cm) kg 17

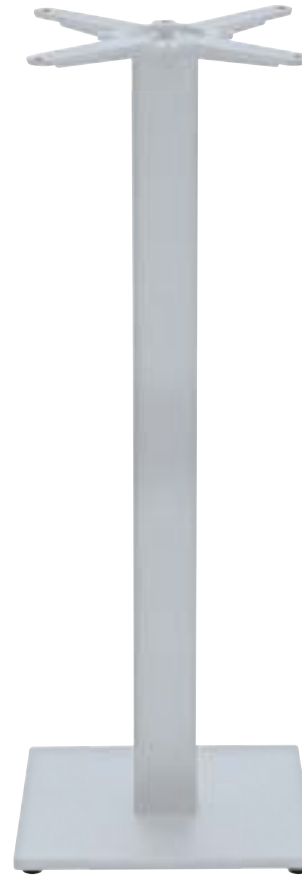

411 - 6028I  
(Ø 40 x H73 cm) kg 12

1272 - 6050L  
(Ø 50 x H73 cm) kg 15

771 - E18SG  
(Ø 58 x H73 cm) kg 17,5

Base in acciaio inox satinato,  
piedini regolabili

*Satin stainless base*

1529 - 18L  
(Ø 40 x H73 cm) kg 12

1531 - 18X  
(Ø 58 x H73 cm) kg 15

Base in alluminio,  
piedini regolabili

*Aluminum base*

414 - 6028C  
(Ø 40 x H73 cm) kg 12

405 - DC400C  
(Ø 50 x H73 cm) kg 15

407 - DC600C  
(Ø 58 x H73 cm) kg 18

Base in acciaio cromato,  
piedini regolabili

*Chromed steel base*



360 - 340N  
Base in ghisa verniciata,  
piedini regolabili

*Cast iron base,  
powder coating*

(Ø 40 x H72 cm) kg 14

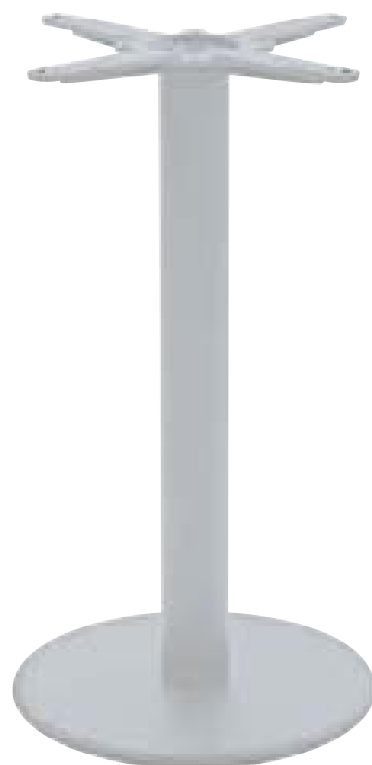
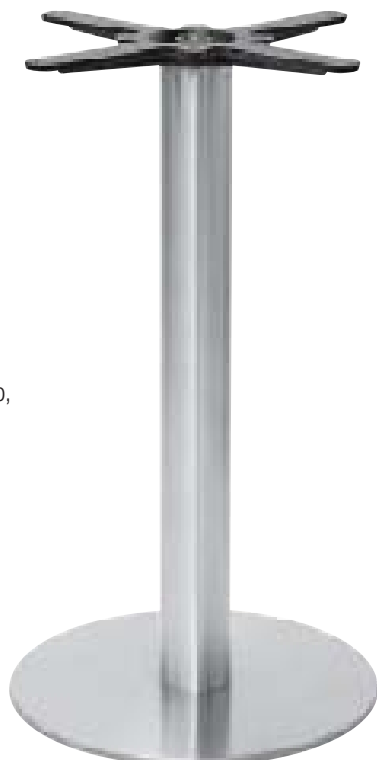



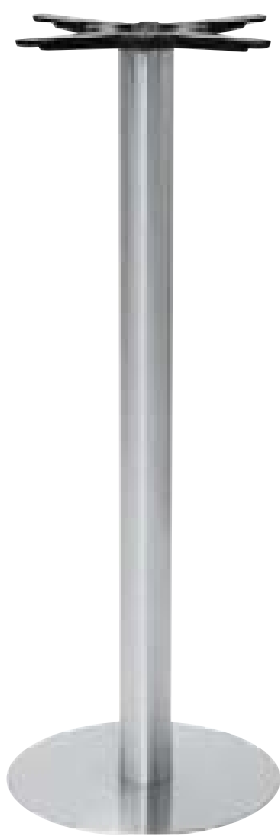

398 - 6029I  
Base in acciaio inox satinato, piedini regolabili

*Satin stainless steel base*  
(Ø 40 x H110 cm) kg 13,5

1530 - 18LH  
Base in alluminio, piedini regolabili

*Aluminum base*  
(Ø 40 x H110 cm) kg 13,5



399 - 6029C  
Base in acciaio cromato, piedini regolabili

*Chromed steel base*  
(Ø 40 x H110 cm) kg 13,5



748 - 34040H  
Base in ghisa verniciata, piedini regolabili

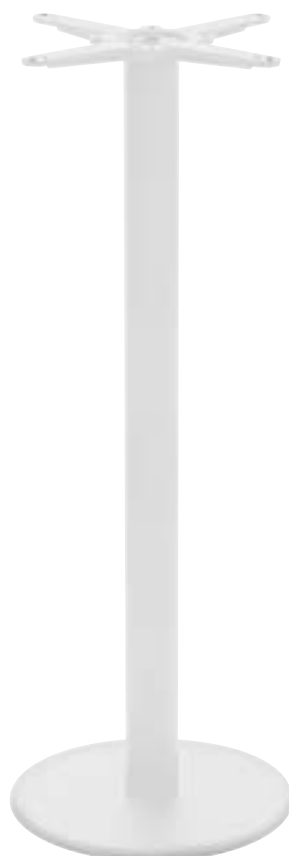

*Cast iron base, powder coating*

(Ø 40 x H110 cm) kg 13,5

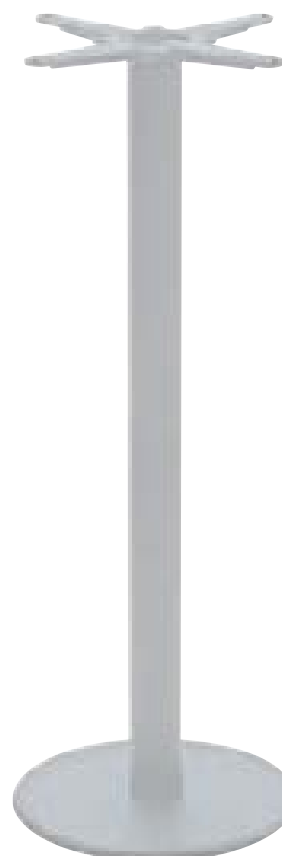



165 - CI159  
Base in ghisa verniciata,  
piedini regolabili  
*Cast iron base, powder coating*  
(42,5 x 42,5 x H 73 cm) Kg 15



166 - CI160  
Base in ghisa verniciata,  
piedini regolabili  
*Cast iron base,  
powder coating*  
(40 x 55 x H73 cm) kg 19



779 - TB131  
Base in ghisa verniciata,  
piedini regolabili  
*Cast iron base,  
powder coating*  
(40 x 60 x H73 cm) kg 19



159 - CI110A  
(Ø 42,5 x H 73 cm) kg 15

160 - CI110B  
(Ø 55 x H 73 cm) kg 21

Base in ghisa verniciata, piedini regolabili  
*Cast iron base, powder coating*



324 - CI110C  
Base in ghisa verniciata, piedini regolabili  
*Cast iron base, powder coating*  
(Ø 42,5 x H108 cm) kg 17



402 - 6033I

Base in acciaio inox satinato, piedini regolabili

*Satin stainless steel base*

(40 x 75 x H73 cm) kg 33



773 - 341C

Base in acciaio cromato, piedini regolabili

*Chromed steel base*

(40 x 70 x H72 cm) kg 33



403 - 341M

Base in ghisa verniciata,  
piedini regolabili

*Cast iron base,  
powder coating*

(40 x 70 x H72 cm) kg 28



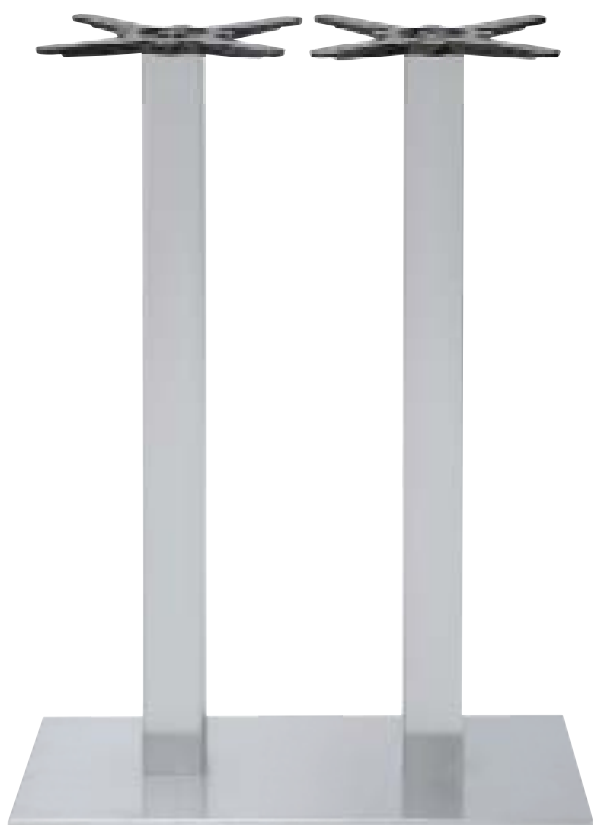

1576 - 6033IH

Base in acciaio inox satinato, piedini regolabili

*Satin stainless steel base*

(40 x 75 x H108 cm) kg 35

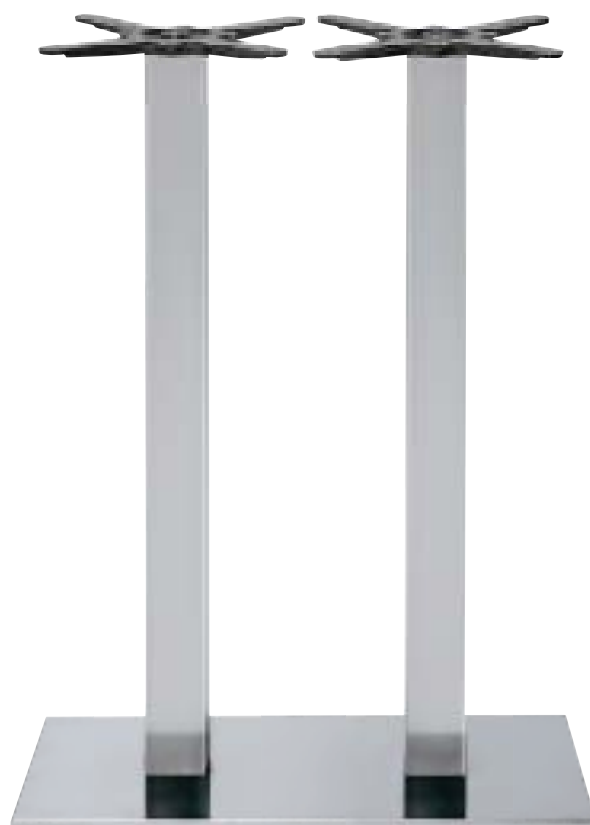

1577 - 341CH

Base in acciaio cromato, piedini regolabili

*Chromed steel base*

(40 x 75 x H108 cm) kg 35

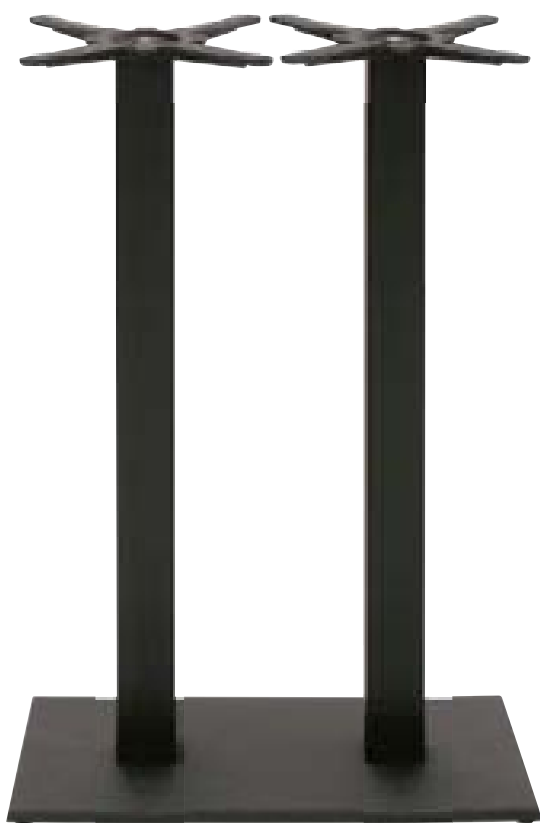

1578 - 341MH

Base in ghisa verniciata, piedini regolabili

*Cast iron base, powder coating*

(40 x 70 x H108 cm) kg 30





156 - CI129  
Base in ghisa verniciata,  
piedini regolabili  
*Cast iron base, powder coating*  
(42,5 x 42,5cm x H 73 cm) Kg. 15,70



157 - CI130  
Base in ghisa verniciata  
*Cast iron base, powder coating*  
(Ø 42,5cm x H 73 cm) Kg. 15



1088 - TB119  
Base in ghisa verniciata  
*Cast iron base, powder coating*  
(79cm x 40cm x H 73 cm) Kg. 32,5



366 - 313

Base in ghisa verniciata,  
pedini regolabili

*Cast iron base, powder coating*  
(Ø 42,5 x H73 cm) kg 18





1351 - T11BR  
(H71 cm) kg 12,5



Struttura in ghisa verniciata,  
effetto bronzo  
*Cast iron frame, powder coating,  
bronze look*

1353 - T11HBR  
(H108 cm) kg 15



169 - CI155-3  
(H 71cm) kg 11,5



Struttura in ghisa verniciata  
*Cast iron frame, powder coating*

170 - CI155-4  
(H 71cm) kg 12,5



661 - 205H  
(H 108 cm) kg 13,5



Struttura in ghisa verniciata  
*Cast iron frame, powder coating*

660 - 210H  
(H 108 cm) kg 15





152 - CA101 (H 70 cm)



1273 - CA108 (H108 cm)



153 - CA102 (H 70 cm)

Struttura in alluminio verniciato  
*Aluminum frame, powder coating*



154 - CA101B  
(H 70 cm)

Basi in alluminio,  
verniciato bambù  
*Aluminum bases,  
bamboo look*



155 - CA102B  
(H 70 cm)



611 - F3

Base in alluminio accatastabile  
con accessorio pieghevole e  
piedini regolabili

*Stackable aluminum base*

(H 72 cm) kg 6,2



W AL N T



1341 - E91

Base in alluminio accatastabile  
con accessorio pieghevole  
e piedini regolabili

*Stackable aluminum base*

(H72 cm)



W AL N





774 - HF3

Base in alluminio accatastabile con accessorio pieghevole e piedini regolabili

*Stackable aluminum base*

(H 110 cm) kg 6,8



W

AL

N

T



973 - TP

Base in alluminio verniciato, piedini regolabili

*Aluminum base powder coating*

(H 70 cm) kg 7,3



920 - MTB013

Base in alluminio verniciato, piedini regolabili

*Aluminum base powder coating*

(H 70 cm)





974 - THP

Base in alluminio verniciato, piedini regolabili

*Aluminum base powder coating*

(H 110 cm) kg 7,7





179 - CS2013  
(H 71 cm) Kg 6,5



180 - CS2014  
(H 71 cm) Kg 8,5



450 - MTB012  
(H 108 cm) Kg 9,5



919 - MTB014  
(H 71 cm) Kg 9,10

Struttura in alluminio,  
acciaio e ghisa, piedini regolabili  
*Stainless steel covering base  
and aluminum tube*





1344 - E90

Base in alluminio con accessorio  
pieghevole e piedini regolabili

*Aluminum base*  
(H72 cm)





138 - L  
(H 103 cm)

Struttura in alluminio,  
piedini regolabili  
*Aluminum bases*



133 - D  
(H 70 cm)



136 - B  
(H 70 cm)



132 - E  
(H 70 cm)



134 - C  
(H 70 cm)



135 - A  
(H 70 cm)



140 - F  
(H 70 cm)



137 - H  
(H 103 cm)

Struttura in alluminio,  
pedini regolabili  
*Aluminum bases*



141 - NA Struttura in alluminio H71 cm,  
tubo Ø 25 x 1,5 mm, per  
piano Ø 60 cm  
*Aluminum frame H71 cm,  
tube Ø 25 x 1,5 mm,  
for top Ø 60 cm*

142 - NB Struttura in alluminio H71 cm,  
tubo Ø 28x1,8 mm,  
per piano Ø 70 cm  
*Aluminum frame H71 cm,  
tube Ø 28 x 1,8 mm,  
for top Ø 70 cm*



143 - OA Struttura in alluminio H71 cm,  
tubo Ø 25 x 1,5 mm,  
per piano 60 x 60 cm  
*Aluminum frame H71 cm,  
tube Ø 25 x 1,5 cm,  
for top 60 x 60 cm*

144 - OB Struttura in alluminio H71cm,  
tubo Ø 28 x 1,8 mm,  
per piano 70 x 70 cm  
*Aluminum frame H71 cm,  
tube Ø 28 x 1,8 mm,  
for top 70 x 70 cm*

145 - OC Struttura in alluminio H71 cm,  
tubo Ø 28 x 1,8 mm,  
per piano 80 x 80 cm  
*Aluminum frame H71 cm,  
tube Ø 28 x 1,8 mm,  
for top 80 x 80 cm*

843 - OD Struttura in alluminio H71 cm,  
tubo Ø 28 x 1,8 mm,  
per piano 120 x 80 cm  
*Aluminum frame H71 cm,  
tube Ø 28 x 1,8 mm,  
for top 120 x 80 cm*



1412 - TB77 (L70 x P70 x H73 cm)

1413 - TB78 (L80 x P80 x H73 cm)

1414 - TB79 (L90 x P90 x H73 cm)

1415 - TB712 (L120 x P80 x H73 cm)

Struttura in alluminio verniciato,  
piedini regolabili

*Aluminum frame, powder coating*



1701 - MB76 (L53 x P53 x H72 cm)

1702 - MB77 (L64 x P64 x H72 cm)

1703 - MB78 (L74 x P74 x H72 cm)

Struttura in alluminio verniciato

*Aluminum frame, powder coating*





656 - 340R

Base in alluminio, rivestimento  
in piattina di polietilene

*Aluminum base, polyethylene  
thread covering*

(Ø40 x H72 cm) kg 12,7

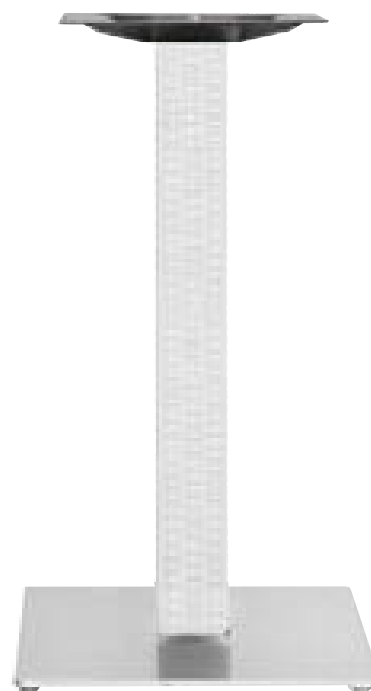

658 - 339Q

Base in alluminio, rivestimento  
in piattina di polietilene

*Aluminum base, polyethylene  
thread covering*

(40 x 40 x H72 cm) kg 15,8

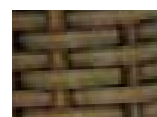

W

N

M



1349 - B80

Struttura in polipropilene,  
zavorra in metallo

*Polypropylene frame,  
ballast metal round plate*  
(Ø40 x H72 cm) kg 11

□ ■  
W N

**PIANI IN BAMBÙ**  
**BAMBOO TOPS**

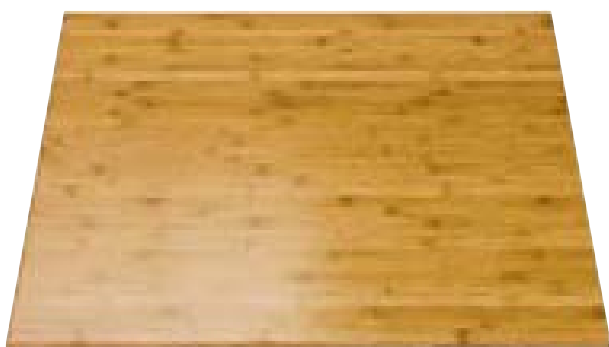

420 - BAS1 (60 x 60 cm)  
421 - BAS2 (70 x 70 cm)  
422 - BAS3 (80 x 80 cm)  
423 - BAS4 (120 x 70 cm)

456 - BAR1 (Ø 60 cm)  
457 - BAR2 (Ø 70 cm)  
458 - BAR3 (Ø 80 cm)

**PIANI IN TEAK**  
**TEAK TOPS**



1216 - TGF258A (Ø 60 cm)  
1217 - TGF258B (Ø 70 cm)  
1218 - TGF258C (Ø 80 cm)

1219 - TGF260A (60 x 60 cm)  
1220 - TGF260B (70 x 70 cm)  
1221 - TGF260C (80 x 80 cm)  
1224 - TGF257C (120 x 70 cm)  
1223 - TGF257B (120 x 80 cm)



**PIANI IN ACCIAIO**  
**STAINLESS STEEL TOPS**

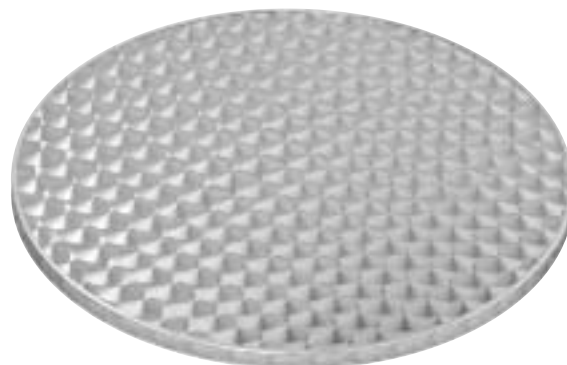
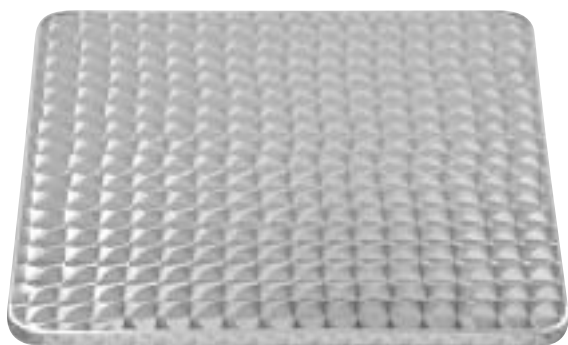

190 - MAS1 (60 x 60cm) (K)  
 191 - MAS2 (70 x 70cm) (K)  
 192 - MAS3 (80 x 80cm) (K)  
 194 - MAS5 (120 x 70cm)  
 776 - MAS7 (120 x 80cm) (K)

187 - MAR1 (Ø 60 cm) (K)  
 188 - MAR2 (Ø 70 cm) (K)  
 189 - MAR3 (Ø 80 cm) (K)

(K) Per uso esterno

**PIANI IN DOGHE DI LEGNO BORDATI IN ALLUMINIO**  
**WOOD BAND TOPS, ALUMINUM EDGE**



199 - MLS1 (60 x 60 cm)  
 200 - MLS2 (70 x 70 cm)  
 201 - MLS3 (80 x 80 cm)  
 203 - MLS5 (120 x 70 cm)

196 - MLR1 (Ø 60 cm)  
 197 - MLR2 (Ø 70 cm)  
 198 - MLR3 (Ø 80 cm)

PIANI PER ESTERNO "ALFA"  
OUTDOOR TOPS "ALFA"



BLANC



ALU



KROMY  
ORANGE



KROMY  
ROUGE



KROMY  
VERT



634 - R060 (Ø 60 cm)

635 - R070 (Ø 70 cm)

636 - R080 (Ø 80 cm)

630 - SQ60 (60 x 60 cm)

631 - SQ70 (70 x 70 cm)

632 - SQ80 (80 x 80 cm)

633 - SQ120 (120 x 80 cm)

PIANI PER ESTERNO "ALFA"  
 OUTDOOR TOPS "ALFA"



KROMY  
 NOIR



ANTRACITE



CALVADOS



TECK



TRAVERTIN



- 634 - R060 (Ø 60 cm)
- 635 - R070 (Ø 70 cm)
- 636 - R080 (Ø 80 cm)

- 630 - SQ60 (60 x 60 cm)
- 631 - SQ70 (70 x 70 cm)
- 632 - SQ80 (80 x 80 cm)
- 633 - SQ120 (120 x 80 cm)

PIANI PER ESTERNO "ALFA"  
OUTDOOR TOPS "ALFA"



MOHOGANY



PAUSSADE  
GRIS

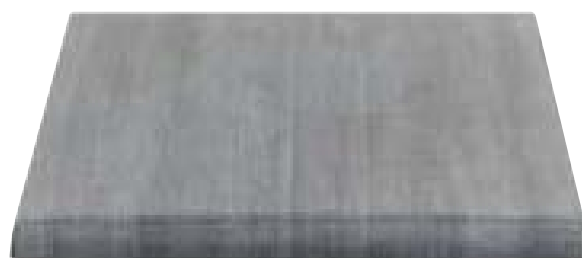

PAUSSADE  
LODGE



SILK  
ANTRACITE



WENGHE



634 - R060 (Ø 60 cm)

635 - R070 (Ø 70 cm)

636 - R080 (Ø 80 cm)

630 - SQ60 (60 x 60 cm)

631 - SQ70 (70 x 70 cm)

632 - SQ80 (80 x 80 cm)

633 - SQ120 (120 x 80 cm)

PIANI PER ESTERNO "ALFA"  
OUTDOOR TOPS "ALFA"

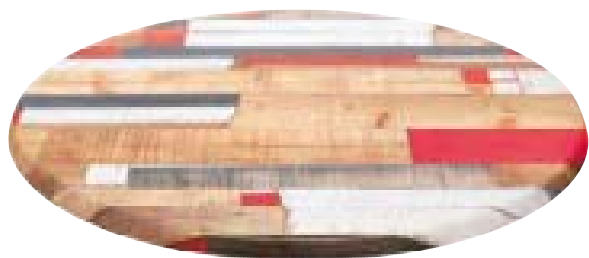

KBANA  
ROUGE

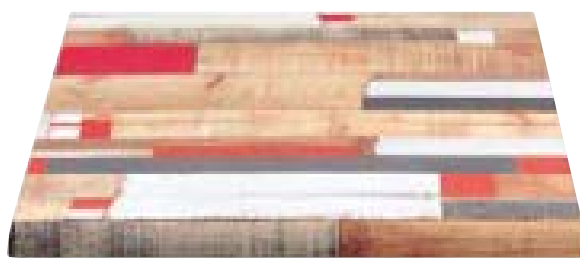

KBANA  
TAUPE



KANSAS



VIRGINIA



KENTUCKY



634 - R060 (Ø 60 cm)

635 - R070 (Ø 70 cm)

636 - R080 (Ø 80 cm)

630 - SQ60 (60 x 60 cm)

631 - SQ70 (70 x 70 cm)

632 - SQ80 (80 x 80 cm)

633 - SQ120 (120 x 80 cm)

PIANI PER ESTERNO "ALFA"  
OUTDOOR TOPS "ALFA"



CALIFORNIE



MARITIMO PINE

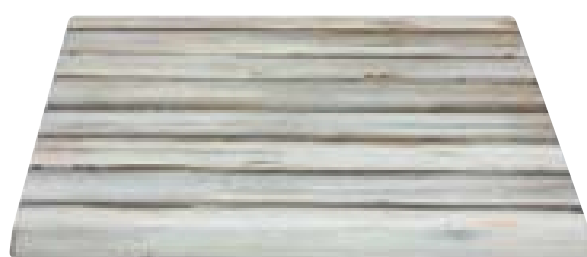

NEWSPAPER



VINTAGE

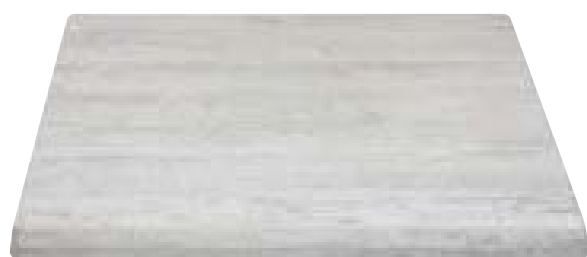

PETROL



634 - R060 (Ø 60 cm)

635 - R070 (Ø 70 cm)

636 - R080 (Ø 80 cm)

630 - SQ60 (60 x 60 cm)

631 - SQ70 (70 x 70 cm)

632 - SQ80 (80 x 80 cm)

633 - SQ120 (120 x 80 cm)

PIANI PER ESTERNO "EXTRA"  
OUTDOOR TOPS "EXTRA"



WASHINGTON



MESSINA



CYPRUS



DARK SLATE



634 - R060 (Ø 60 cm)

635 - R070 (Ø 70 cm)

636 - R080 (Ø 80 cm)

630 - SQ60 (60 x 60 cm)

631 - SQ70 (70 x 70 cm)

632 - SQ80 (80 x 80 cm)

633 - SQ120 (120 x 80 cm)

PIANI IN STRATIFICATO HPL  
HPL PRESSURE LAMINATE TOPS



ANTRACITE / ANTHRACITE

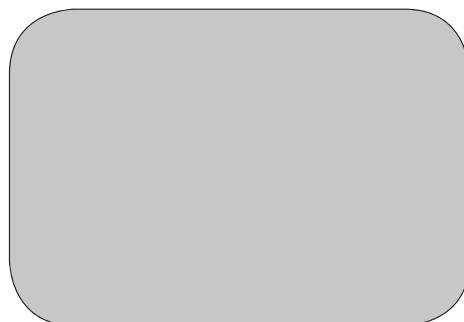

GRIGIO / GREY

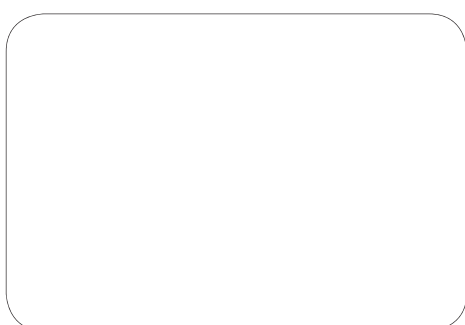

BIANCO / WHITE

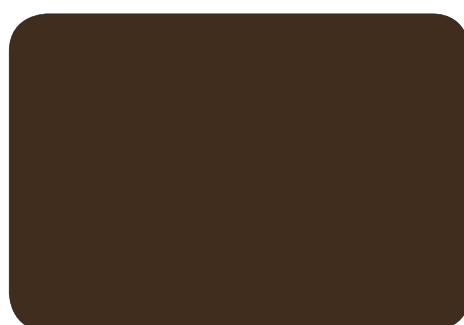

MOKA / MOKA



NERO / BLACK



ALLUMINIO / ALUMINUM

spessore / thickness  
10 mm

- |                        |                             |
|------------------------|-----------------------------|
| 1704 - ART59 (Ø 60 cm) | 1707 - AST59 (60 x 60 cm)   |
| 1705 - ART69 (Ø 70 cm) | 1708 - AST69 (70 x 70 cm)   |
| 1706 - ART79 (Ø 80 cm) | 1709 - AST79 (80 x 80 cm)   |
|                        | 1710 - AST119 (120 x 80 cm) |

spessore / thickness  
12 mm

- |                      |                           |
|----------------------|---------------------------|
| 848 - RT59 (Ø 60 cm) | 844 - ST59 (60 x 60 cm)   |
| 849 - RT69 (Ø 70 cm) | 845 - ST69 (70 x 70 cm)   |
| 850 - RT79 (Ø 80 cm) | 846 - ST79 (80 x 80 cm)   |
|                      | 847 - ST119 (120 x 80 cm) |

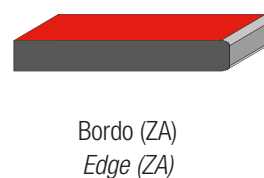
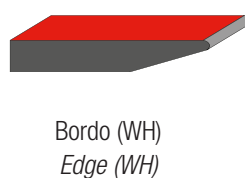
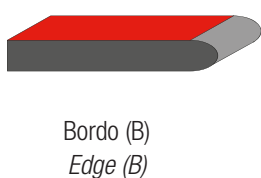
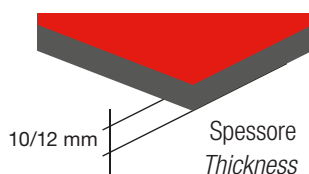



PIANI IN STRATIFICATO HPL  
HPL PRESSURE LAMINATE TOPS



WENGÉ



GREY WOOD



METALLIC



SLEEK GREY



SLEEK LIGHT GREY



BROOKLYN DARK



COPPER PAINTED



SLATE

PIANI IN LAMINATO / LAMINATE TOPS



BIANCO LARIX 9003

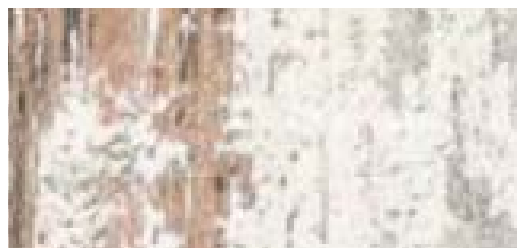

VINTAGE 6300



ROVERE SBIANCATO 1014

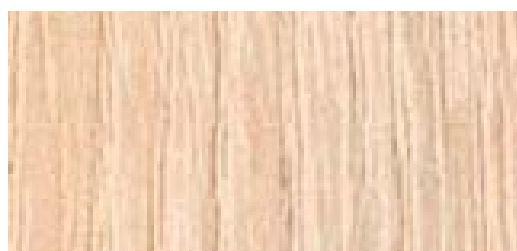

ROVERE NATURALE 1001

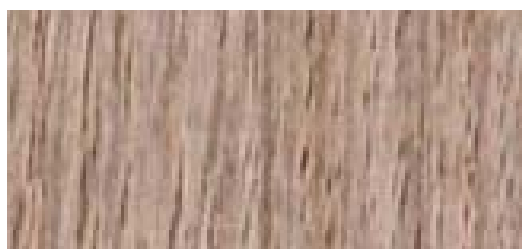

ROVERE GRIGIO MEDIO 7006



OLMO GRIGIO SCURO 7022

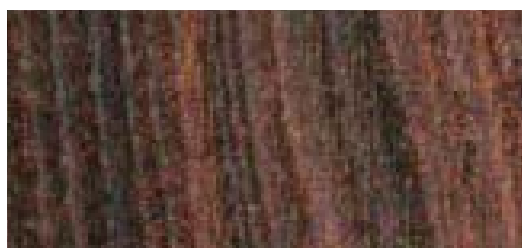

OLMO TINTO 8028

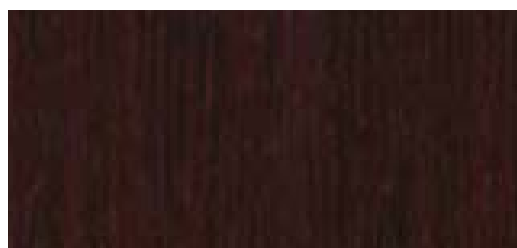

WENGE 8019

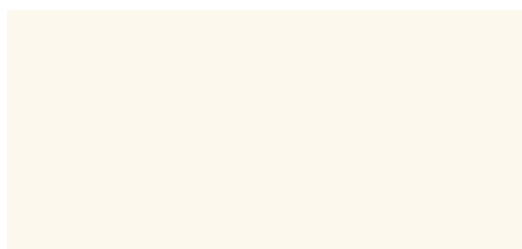

BIANCO

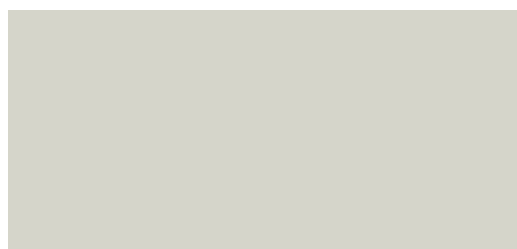

GRIGIO CHIARO

## PIANI IN LAMINATO / LAMINATE TOPS

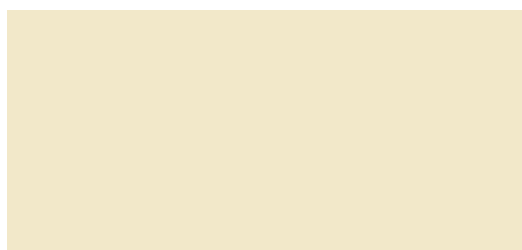

MAGNOLIA



ALLUMINIO



ANTRACITE

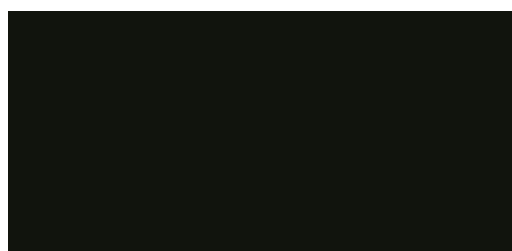

NERO

**BORDO ABS IN TINTA**  
**ABS EDGE**

SPESSORE 24mm / THICKNESS 24mm

1356 - ST60 (60 x 60 cm)	1360 - RT60 (Ø 60 cm)
1357 - ST70 (70 x 70 cm)	1361 - RT70 (Ø 70 cm)
1358 - ST80 (80 x 80 cm)	1362 - RT80 (Ø 80 cm)
1359 - ST120 (120 x 80 cm)	

SPESSORE 30mm / THICKNESS 30mm

1363 - ST63 (60 x 60 cm)	1367 - RT63 (Ø 60 cm)
1364 - ST73 (70 x 70 cm)	1368 - RT73 (Ø 70 cm)
1365 - ST83 (80 x 80 cm)	1369 - RT83 (Ø 80 cm)
1366 - ST123 (120 x 80 cm)	

SPESSORE 40mm / THICKNESS 40mm

1370 - ST64 (60 x 60 cm)	1374 - RT64 (Ø 60 cm)
1371 - ST74 (70 x 70 cm)	1375 - RT74 (Ø 70 cm)
1372 - ST84 (80 x 80 cm)	1376 - RT84 (Ø 80 cm)
1373 - ST124 (120 x 80 cm)	

SPESSORE 50mm / THICKNESS 50mm

1377 - ST65 (60 x 60 cm)	1381 - RT65 (Ø 60 cm)
1378 - ST75 (70 x 70 cm)	1382 - RT75 (Ø 70 cm)
1379 - ST85 (80 x 80 cm)	1383 - RT85 (Ø 80 cm)
1380 - ST125 (120 x 80 cm)	

**BORDO IN GOMMA**  
**RUBBER EDGE**

SPESSORE 24mm / THICKNESS 24mm

1384 - STG60 (60 x 60 cm)	1388 - RTG60 (Ø 60 cm)
1385 - STG70 (70 x 70 cm)	1389 - RTG70 (Ø 70 cm)
1386 - STG80 (80 x 80 cm)	1390 - RTG80 (Ø 80 cm)
1387 - STG120 (120 x 80 cm)	

SPESSORE 27mm / THICKNESS 27mm

1391 - STG62 (60 x 60 cm)	1395 - RTG62 (Ø 60 cm)
1392 - STG72 (70 x 70 cm)	1396 - RTG72 (Ø 70 cm)
1393 - STG82 (80 x 80 cm)	1397 - RTG82 (Ø 80 cm)
1394 - STG122 (120 x 80 cm)	

SPESSORE 30mm / THICKNESS 30mm

1398 - STG63 (60 x 60 cm)	1402 - RTG63 (Ø 60 cm)
1399 - STG73 (70 x 70 cm)	1403 - RTG73 (Ø 70 cm)
1400 - STG83 (80 x 80 cm)	1404 - RTG83 (Ø 80 cm)
1401 - STG123 (120 x 80 cm)	

**PIANI IN MELAMMINICO & LAMINATO PERSONALIZZATI**  
***CUSTOM MADE MELAMINE & LAMINATED TOPS***

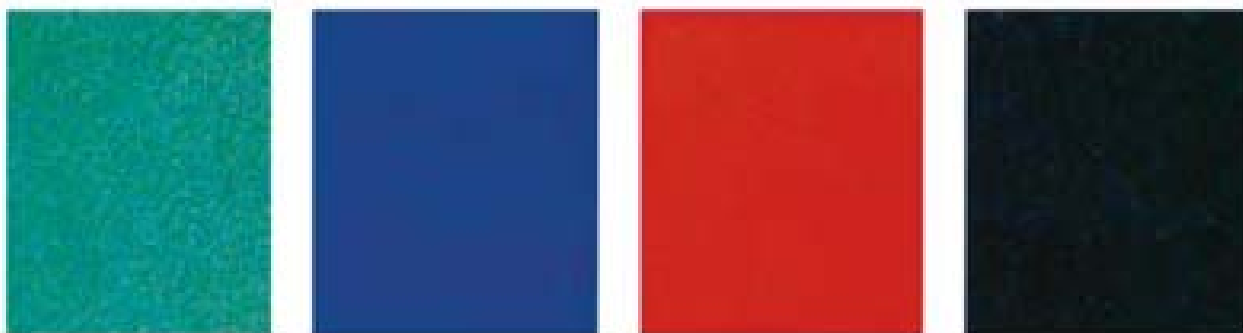

**Caratteristiche richieste:**

- Dimensioni
- Spessore
- Legno multistrato o panforte
- Colore
- Bordo

***Requested characteristics:***

- Sizes
- Thickness
- Multilayer wood or play wood
- Colours
- Edge

**PER I COLORI DEI PIANI IN LAMINATO CONSULTARE I SITI:**  
***FOR THE LAMINATED TOP COLOURS LOOK UP THE SITES:***

**[www.abet-laminati.it](http://www.abet-laminati.it)**  
**[www.arpaindustriale.com](http://www.arpaindustriale.com)**

**PIANI IN STRATIFICATO HPL PERSONALIZZATI**  
***CUSTOM MADE HPL PRESSURE LAMINATE TOPS***

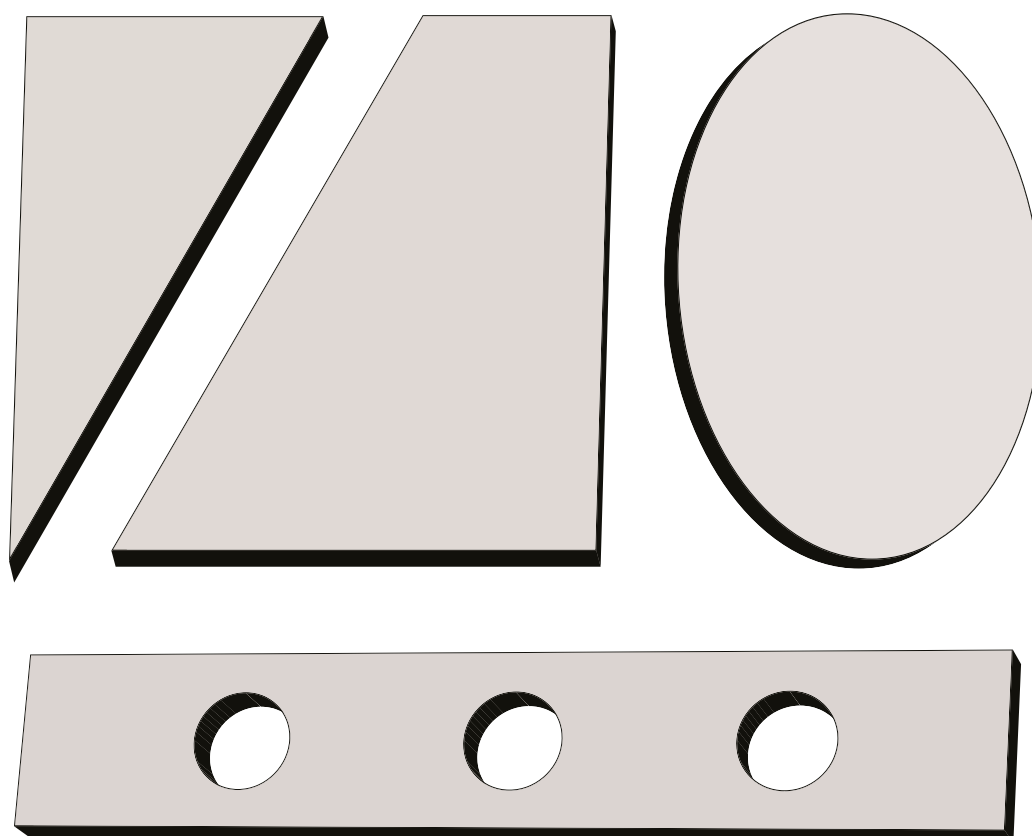

**Caratteristiche richieste:**

- Dimensioni
- Spessore (10-12 mm)
- Colore (vedi pag. 408-409)
- Bordo (vedi pag. 408)

***Requested characteristics:***

- Sizes
- Thickness (10-12 mm)
- Colours (pages 408-409)
- Edge (page 408)



**Basi & piani  
per tavoli**

***Table bases  
& tops***



**Arredi  
luminosi**

***Light  
furniture***

Gli arredi luminosi a led che vi proponiamo sono adatti per qualsiasi locale pubblico di intrattenimento e di ospitalità, dove possono essere impiegati sia per uso esterno che interno. La coreografia che vengono a creare grazie all'alternanza dei colori permette di rendere più suggestivi e attraenti bar, pub, discoteche, ristoranti, piscine, hotel ecc.

## **Caratteristiche:**

- involucro in polietilene di alta qualità molto resistente
- luci a led con alimentazione a batteria incorporata, i led hanno un bassissimo consumo 40%-80% meno delle lampade tradizionali e una lunga durata
- tempo di carica delle batterie 4-8 ore
- durata della carica 8-10 ore
- il comando delle luci avviene a mezzo telecomando, con la possibilità di scegliere fra 16 colori oppure alternandoli automaticamente
- caratteristiche di impermeabilità all'acqua pari a IP54 / IP65.

*The bright LED fittings are suitable for any public venue.*

*The choreography, which are created by alternating the colors, makes it more beautiful and attractive bars, pubs, discos, restaurants, swimming pools, hotels etc...*

## **Characteristics:**

- *Housing made of polyethylene of high quality durable*
- *LED lights built-in battery-powered*
- *Battery charging time 4-8 hours*
- *Charging time 8-10 hours*
- *The command is done by remote control of lights, with a choice of 16 colors or alternating them automatically*
- *Features water resistance equivalent to IP54 / IP65.*





2000 - NJ1530L  
(L40 x P40 x H40 cm)



2002 - NJ1535  
(Ø 42 x H45 cm)



2015 - BZFL010  
Con RGB  
*With RGB*  
(L47 x P47 x H90 cm)





2009 - NJ1531  
(L45 x P45 x H54 cm)



2026 - BZCH5506L  
(Ø 54 cm x H54 cm)



2019 - BZBE302  
(Ø 34 x H27 cm)





2031 - BZ0107L  
 (Ø 40 cm) Con RGB  
 With RGB

2032 - BZ0108L  
 (Ø 61 cm) Con RGB  
 With RGB

2033 - BZ0109L  
 (Ø 85 cm) Con RGB  
 With RGB



2059 - MD11  
 (L46 x P46,5 x H86 cm)





2030 - NM1632  
Con RGB  
*With RGB*  
(L160 x P72 x H102 cm)

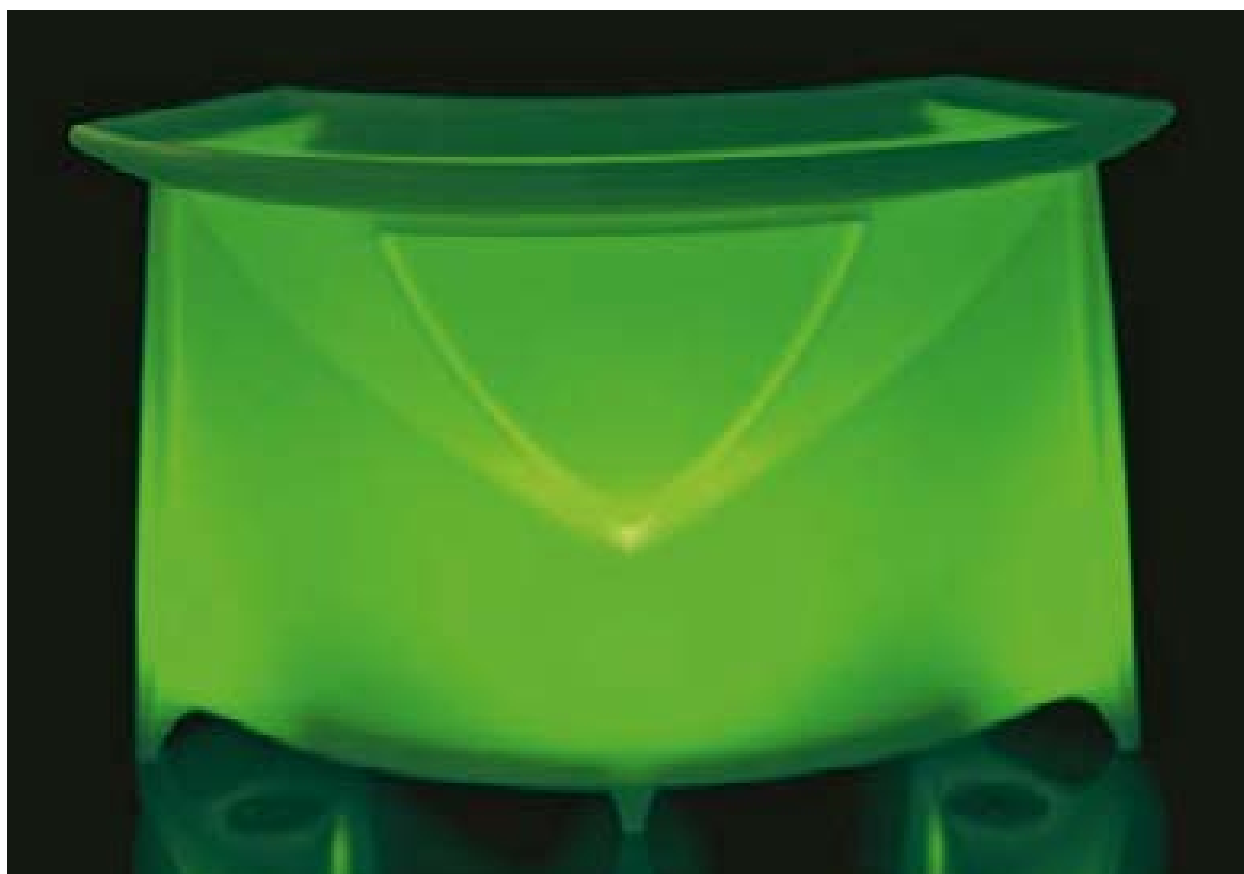



2029 - BZCH5508L  
Con RGB  
*With RGB*  
(L138 x P70 x H106 cm)

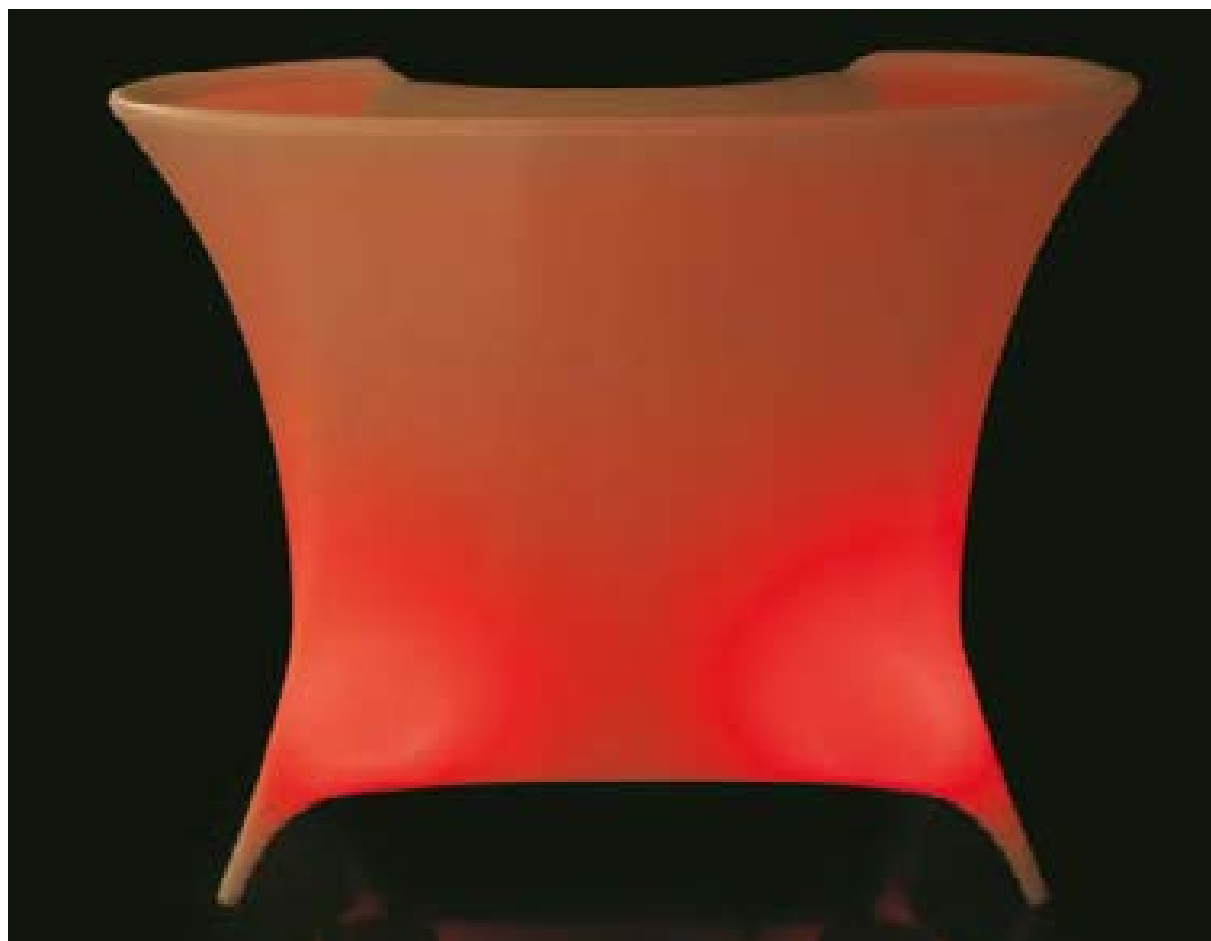



2041 - M447  
Con RGB/With RGB  
(L70 x P102 x H109 cm)



2040 - M446  
Con RGB/With RGB  
(L70 x P70 x H109 cm)





**Arredi  
luminosi**

***Light  
furniture***



AR



**AR**<sup>®</sup> ROSSANESE

**ESSE SOLUTION**<sub>SAGL</sub>

FORNITURE AZIENDALI

Via Rompada, 37 - CASLANO

+41 076 758 5368 +41 079 709 8354

[www.essesolution.ch](http://www.essesolution.ch) [info@essesolution.ch](mailto:info@essesolution.ch)

